



**Manual**  
**Neon 3000 Family**  
**Neon Remote Loggers (NRL)**

This equipment has been tested and found to comply with the limits for a Class A digital device, pursuant to Part 15 of the FCC Rules in the U.S.A. These limits are designed to provide reasonable protection against harmful interference when the equipment is operated in a commercial environment. This equipment generates, uses, and can radiate radio frequency energy and, if not installed and used in accordance with the instruction manual, may cause harmful interference to radio communications. Operation of this equipment in a residential area is likely to cause harmful interference in which case the user will be required to correct the interference at his/her own expense.

This equipment has been tested for compliance with European regulations as follows:

Application of Council Directive:  
2014/30/EU

Standards to which Conformity is declared:

CISPR 11:2010, Group 1, Class A  
EN-61000-4-2:2008  
EN-61000-4-3:2010  
EN-61000-4-4:2012  
EN-61000-4-5:2005  
EN-61000-4-6:2008

Any changes or modifications to this equipment not expressly approved by the manufacturer Unidata Pty Ltd could void the user's authority to operate this equipment.



**Revision History**

File name/Revision	Date	Author & Change Details	Checked approved
Unidata Manual - 3000 NRL Family - 04 10 2019.docx	14 06 17	IM - draft	MS
Unidata Manual - 3000 NRL Family - 04 10 2019.docx	16 06 17	RS&IM adding specs & LCD functions	MS
Unidata Manual - 3000 NRL Family - 04 10 2019.docx	20 06 17	MS- added text	CB
Unidata Manual - 3000 NRL Family - 04 10 2019.docx	11 07 18	IM New Specs for 3004B	MS
Unidata Manual - 3000 NRL Family - 04 10 2019.docx	23 07 18	MS connectivity additions	CB
Unidata Manual - 3000 NRL Family - 04 10 2019.docx	13 09 18	AG MS Updates	IM
Unidata Manual - 3000 NRL Family - 04 10 2019.docx	17 09 18	IM adding 3001B Info	MS
Unidata Manual - 3000 NRL Family - 04 10 2019.docx	12 02 19	DM add 3001 pinouts	MS
Unidata Manual - 3000 NRL Family - 04 10 2019.docx	02 04 19	IM Fixing Counter Ch info	DM
Unidata Manual - 3000 NRL Family - 04 10 2019.docx	18 06 19	DM update 3001 info	MS
Unidata Manual - 3000 NRL Family - 04 10 2019.docx	21 06 19	DM revise 3004,3008 silkscreens, connection details	MS
Unidata Manual - 3000 NRL Family - 04 10 2019.docx	27 06 19	DM revise 5.5.8 and 5.5.10	MS
Unidata Manual - 3000 NRL Family - 04 10 2019.docx	06 08 19	IM Deleting Globalstar info	MS
Unidata Manual - 3000 NRL Family - 04 10 2019.docx	04 10 19	IM Adding info about 3001M and 3001G	DM
Unidata Manual - 3000 NRL Family - 04 10 2019.docx	07 10 19	DM Add Iridium MBP setup info	MS
Unidata Manual - 3000 NRL Family - 23 10 2019.docx	23 10 19	DM Add Lora MBP setup info	CB
Unidata Manual - 3000 NRL Family - 24 02 2020.docx	24 02 20	CB Add LoRa menu system info	DM

Copyright © Unidata Pty Ltd 2000-2019. All rights reserved. No part of this publication may be reproduced, transmitted, transcribed, stored in a retrieval system, or translated into any spoken or computer language, in any form or by any means. Electronic, mechanical, magnetic, optical, chemical, manual or otherwise, without prior written permission of Unidata Pty Ltd 40 Ladner St, O'Connor Western Australia 6163.

**TABLE OF CONTENTS**

<b>1.0</b>	<b>Neon Technology and System Overview .....</b>	<b>5</b>
1.1	Neon Remote Loggers .....	7
1.2	Typical Neon Measurement System .....	7
1.3	The NRL Stand Alone Data logger Implementation .....	8
1.4	The NRL Full Protocol Implementation - Internet Connection Required .....	8
1.5	The NRL Message Based Implementation- LoRa LPWAN & Satellite Services .....	8
1.5.1	Message Based Protocol (MBP) Scheme Configuration .....	9
1.5.2	Message Based Protocol (MBP) Neon Configuration – Iridium SBD .....	11
1.5.3	Message Based Protocol (MBP) Neon Configuration – LoRa WAN .....	12
1.5.4	Program Neon Remote Logger With the Scheme Program .....	13
1.5.5	NRL LoRa Configuration .....	13
1.6	NRL Internal Architecture .....	15
1.7	NRL Models .....	16
1.8	NRL Programs (Schemes) and Prologger / Starlogger Emulation Mode .....	16
1.9	NRL New Features .....	16
1.10	NRL Data Storage options .....	16
1.10.1	Flash .....	16
1.10.2	MMC/SD Card .....	16
1.10.3	USB Thumbdrive .....	17
<b>2.0</b>	<b>NRL LED Indicators .....</b>	<b>17</b>
2.1	3016, 3008, 3004 “High End” .....	17
2.2	3004M “Mid-Range” and 3001M “Low End” .....	17
2.3	Normal Scheme Indication .....	18
2.4	Telemetry Indication .....	18
2.5	Direct Connection Indication .....	18
2.6	Firmware Update Indication .....	18
<b>3.0</b>	<b>NRL Status Menu Screens .....</b>	<b>18</b>
3.1	Logger Status Screen Navigation .....	20
3.2	Scheme Status Data .....	21
3.3	Configure Logger .....	21
3.3.1	General Configuration Parameters .....	22
3.3.2	Communication Parameters .....	23
<b>4.0</b>	<b>Summary of Neon Remote Loggers .....</b>	<b>23</b>
4.1	3016 Neon Remote Logger – 16 Analogue Channels .....	24
4.1.1	3016 Specifications .....	24
4.2	3008 Neon Remote Logger – 8 Analogue Channels .....	25
4.2.1	3008 Specifications .....	26
4.3	3004/3006 Neon Remote Logger – 4 Analogue Channels .....	27
4.3.1	3004 Specifications .....	27
4.4	3004-M Neon Remote Logger .....	29
4.4.1	3004-MC/E/H/I/L Specifications .....	29
4.5	3001- M or G C/H/I/L NRL Cellular, LoRa, Iridium SBD or Microsatellite .....	30
4.5.1	3001- M or G C/H/I/L Specifications .....	32
4.5.2	3901A Lithium Battery Pack Specifications .....	33
<b>5.0</b>	<b>Connections .....</b>	<b>33</b>
5.1	3016 Neon Remote Logger – Connections/Terminations .....	33
5.2	3008 Neon Remote Logger – Connections/Terminations .....	36
5.3	3004 Neon Remote Logger – Connections/Terminations .....	38
5.4	3004-M000 – Connections/Terminations .....	40
5.5	3001-M0 Neon Remote Nano Logger – Connections/Terminations .....	42
5.5.1	Option 1 SDI-12 INSITU Sensor .....	42
5.5.2	Option 2 Modbus INSITU Sensor .....	42
5.5.3	Option 3 4-20mA INSITU Current Loop Sensor .....	43

5.5.4	Option 4 SQL Modbus Sensor .....	43
5.5.5	Option 5 SQL SDI-12 Sensor .....	44
5.5.6	Option 6 SQL Voltage Sensor .....	44
5.5.7	Option 7 SQL 3 wire 4-20mA sensor .....	45
5.5.8	Option 8 SQL 2 wire 4-20mA sensor .....	45
5.5.9	Option 9 SQL Counter Input .....	46
5.5.10	Configuring Input Signal Jumpers .....	46
5.5.11	SQL Signal 7 Pin Input Connector Pinout .....	47
5.5.12	Insitu Signal 6 Pin Input Connector Pinout .....	47
5.5.13	M12 Power 4 Pin Input (Male) Connector Pinout .....	47
5.5.14	M12 Power 4 Pin Output (Female) Connector Pinout .....	47
5.5.15	Lithium Battery Pack Jumper Cable .....	47
5.5.16	External Power Cable .....	47
<b>6.0</b>	<b>Appendix Inserting SIM Card and SD Card .....</b>	<b>49</b>
6.1	NRL 3001 .....	50

## References

This manual should be read in conjunction with the associated

- Starlog 4 User Manual Management Software for Loggers and Neon Terminals and Loggers Manual
- Neon Server Applications Software Documentation which is available on help screens on any Neon Installation and in PDF form from the main Unidata web site

This manual and the StarlogV4 User Manual and the Neon Server User & Administrator Documentation form part of the documentation suite for the overall Neon System.

## 1.0 NEON TECHNOLOGY AND SYSTEM OVERVIEW

The Neon system collects measurements from Neon Field Units / Neon Remote Loggers (NRL) connected to field instruments and sensors and transmits these measurements to a central Neon Web based system for data storage, analysis, data presentation, graphical analysis and reporting and data transfer to other external systems.

The Neon system also provides facilities for remote management of Neon Field Units / Neon Remote Loggers via the Neon Web interface to allow for remote reconfiguration, sensor input changes and local program changes thereby minimising trips to site and reducing cost.

The communication protocol between Neon Field Units / Neon Remote Loggers and the central Neon Server is Internet Protocol / TCP/IP and LoRa LPWAN technology protocol.

The communications method between Neon Field Units / Neon remote Loggers and the central Neon Server can be any method which utilises TCP/IP, and we support Cell Phone, Wi-Fi, Direct Ethernet, Inmarsat BGAN M2M Satellite, Globalstar Satellite, Iridium Satellite and LoRa LPWAN across public and private networks.

The Starlog 4 software is a desktop application which assists with the setup of Neon Field Unit / Neon Remote Logger configuration. This software allows for a point and click setup of Neon Field Unit / Neon Remote Logger internal programs, called schemes. Schemes are downloaded to the Neon Field Units / Neon Remote Loggers via a serial interface direct to the Neon Field Unit / Neon Remote Logger or uploaded to the Neon Web interface to be downloaded to a neon Field Unit / Neon Remote Logger in the field via the Neon network.

The Neon system is offered to customers based on two options:

- A customer owned server model, where the customer purchases a Neon Application Software licence from Unidata and runs that software on their own servers,

or

- A hosted application service model where Unidata provides access to run the system on Unidata secure cloud servers on a fee for service basis.

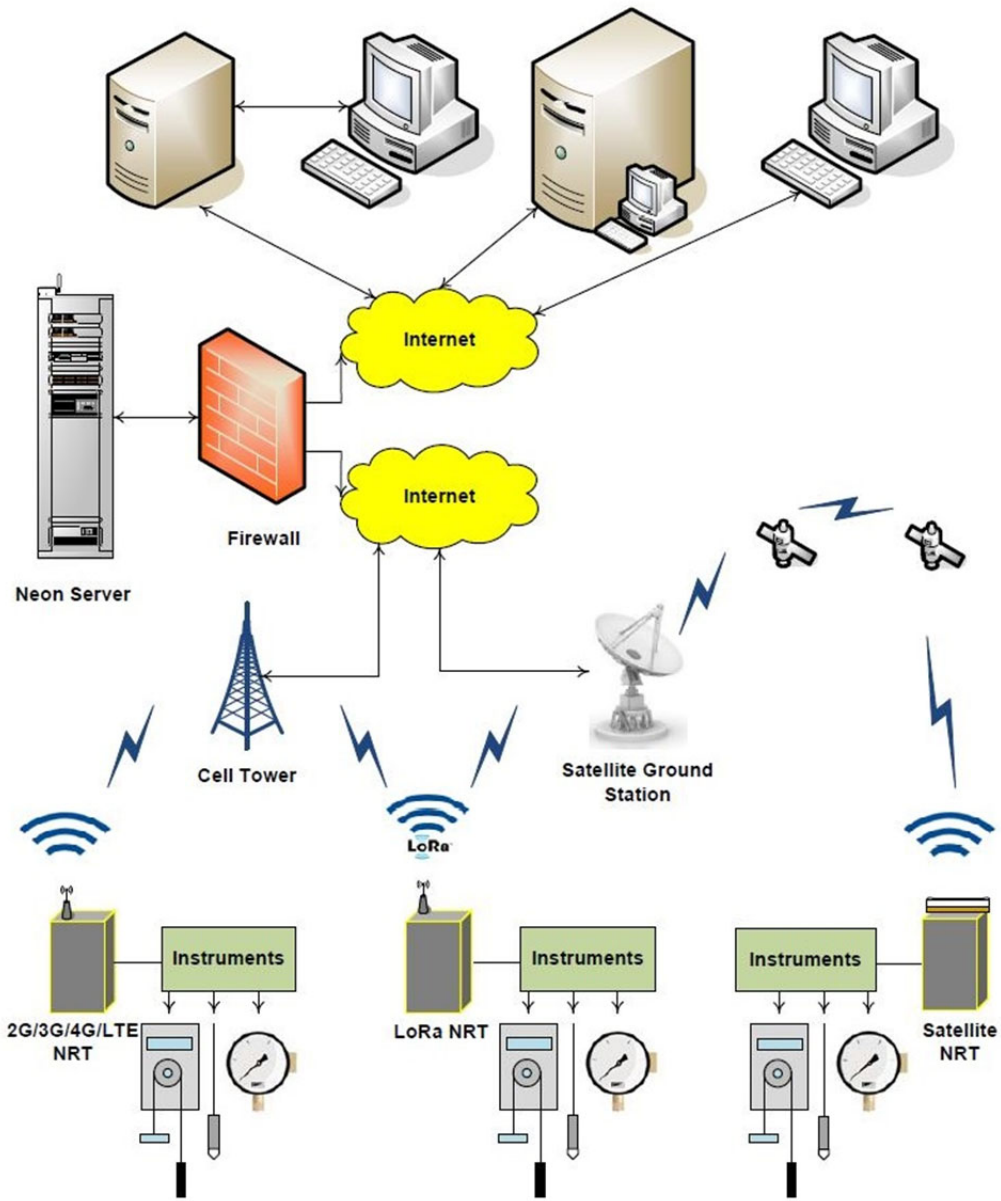

Overview of the Neon System

### 1.1 Neon Remote Loggers

There are many different models of Neon Remote Loggers available. While the models may be different, and the interfaces available in various models are different, the basic operation of all Neon Remote Loggers is the same.

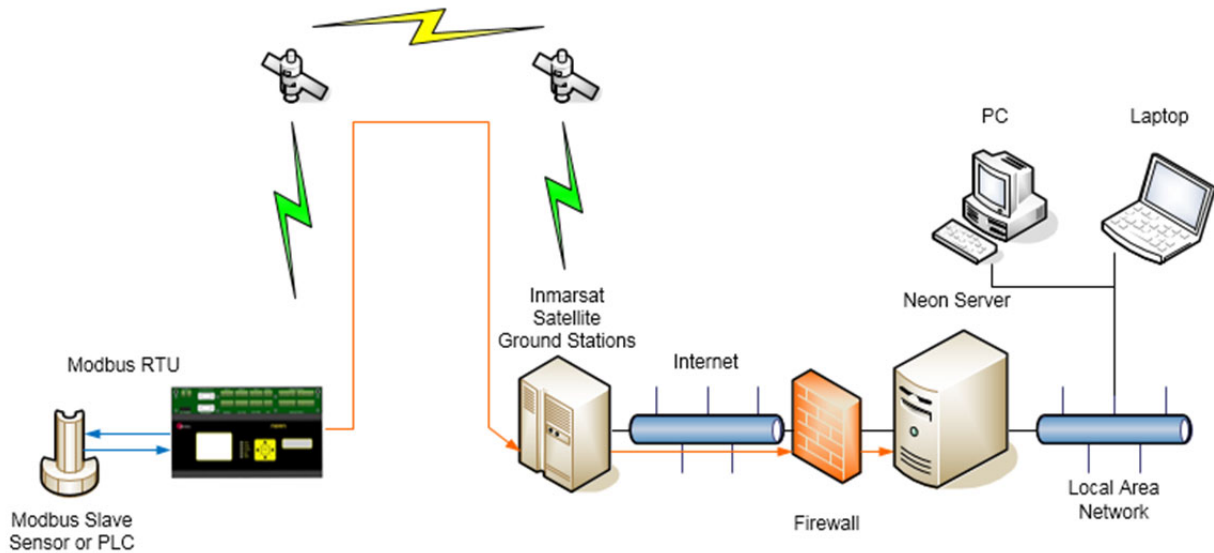

Typical Neon Measurement System

### 1.2 Typical Neon Measurement System

The figure above is an example of a Neon installation showing an NRL connected to a Modbus sensor. Every day the NRL will send, via the Inmarsat satellite network, to the Neon server a “packet” of information containing the data in raw format.

The Neon Server then extracts the raw data from the packet. The data is then stored on a secure server until the client accesses the data using a standard Web Browser.

The Neon Server receives, processes, displays, stores and reports collected data in many ways.

The Neon Server also can issue control commands based on pre-set algorithms and issue alarms and notifications via several mediums.

Alarm set points can be set up on the NRL units as well as the Neon Server and alarm notifications can be sent via several methods including email and SMS text messages.

Alarm triggers can initiate physical actions in the field such as turning pumps on and off or activating other control functions based on the internal program within the NRL.

The Neon system has fully bi-directional communications between the NRL and the Neon Server. This allows for remote diagnosis, remote programming and remote firmware updating for operation of the remote equipment and thereby reducing costly site visits.

NRL units can be configured to read sensors, log data internally to local memory and push data to the central Neon server at user settable intervals such as once a minute, every few minutes, every hour, or once a day.

Data can be viewed on the Neon Web interface in near real time from any browser and the comprehensive reporting engine within Neon allows for reporting out to other systems using email, FTP, and web services, either dynamically, every minute, or on a daily, monthly, quarterly or annual basis.

### **1.3 The NRL Stand Alone Data logger Implementation**

The NRL can be programmed with a program (scheme) in the factory or in a remote office and then transported to the field to work as a stand-alone system, without the need to have an internet connection. For this operation method the program (scheme) is downloaded to the NRL using the Starlog 4 Logger configuration software. The data is stored in the NRL and can be unloaded using the Starlog 4 Logger configuration software.

The Starlog 4 Logger configuration can be used to set up legacy logger emulations, such as the Star logger and Prologger, so applications using these older loggers can continue using the newer NRL models. If the emulation modes are used, the new features available in the NRL are not available. Unidata suggests the program (scheme) should be updated to utilise the features available in the newer NRL models.

### **1.4 The NRL Full Protocol Implementation - Internet Connection Required**

The Internet provides the transport mechanism between the Neon Servers and the telecommunication provider gateways. This means that NRL units can be used anywhere in the world provided there is an internet connection available. The connection to the internet can be via a cell phone data service, a satellite service or a Wi-Fi or Ethernet connection.

With the full protocol service the communications between the NRL and the Neon Server are closely coupled and each transmission is checked and acknowledged, such that a break in communications does not result in lost data. Rather the NRL attempts to communicate with the Neon Server on a pre-set schedule and continues to log and store data and then re-send if and when the communications link and/or the Neon Server service is restored.

Also the remote NRL can be configured online, parameters can be adjusted and a new program (scheme) and updated firmware can be downloaded remotely from the Neon Server.

### **1.5 The NRL Message Based Implementation- LoRa LPWAN & Satellite Services**

There are communications services available which provide a short message service, similar to an SMS text message service.

The NRL supports LoRa LPWAN, Iridium Short Burst Data service and also other emerging message based services. These services are in general terms message only services, where a message is sent from the NRL to the Neon Server without acknowledgement, without the ability to reconfigure NRL on line and without the ability to download programs (schemes). These message based services are generally lower cost and they suit low data rate applications very well and are less expensive. There are three steps involved in using the Message Based Protocol



### 1.5.1 Message Based Protocol (MBP) Scheme Configuration

There are several settings that must be configured in your logger scheme program to use the MBP mode. In the instruments window, double click on the NRL Logger Support and Configuration

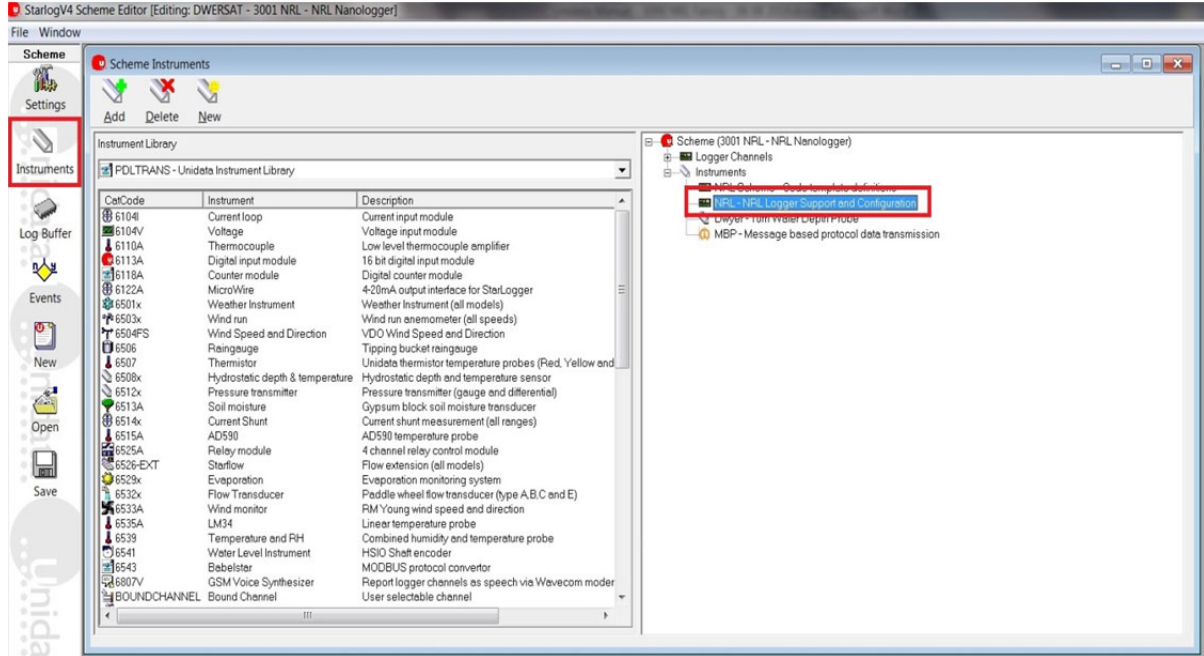

For NRL Communications, select MBP Mode (LoRa, SBD etc)

Under the UTC Offset dropdown box, select the UTC offset to match what has been set in the Neon Server for this node under the Node Details, Time Zone setting. For example Perth, Western Australia is UTC+8 time zone

Click OK when done

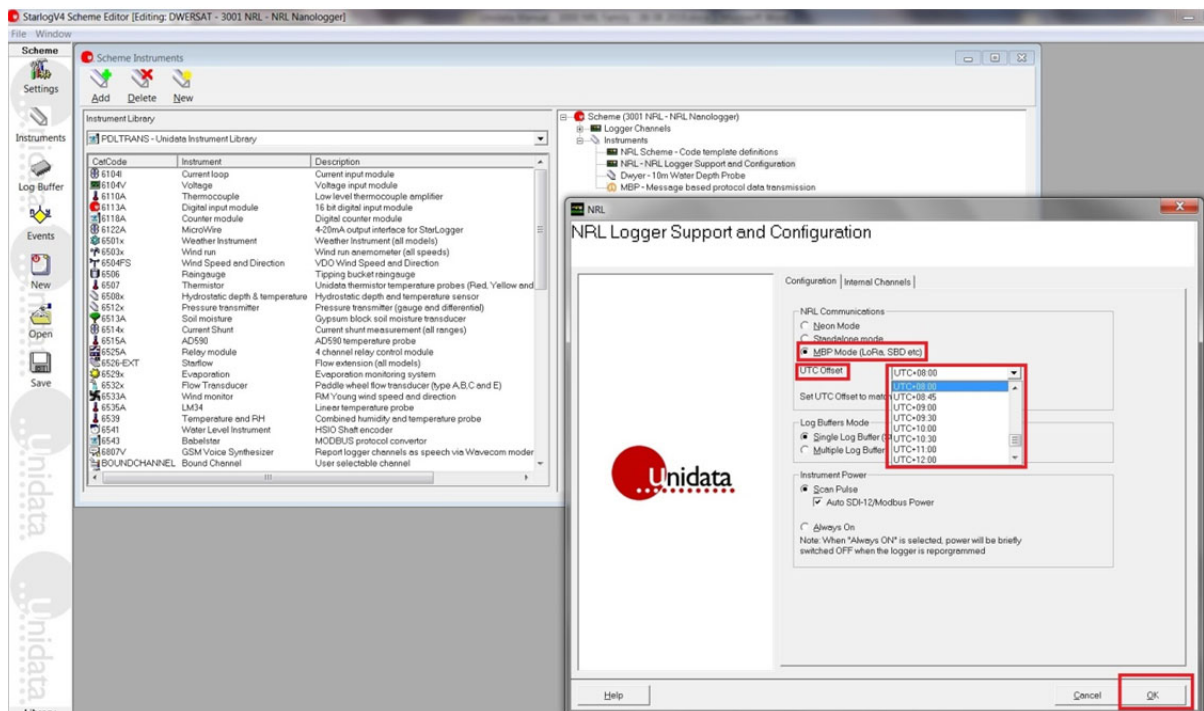

The next step is to add the MBP instrument to your scheme. Ensure that the Instrument library is set to PDLTRANS. Under the Instruments list double click on MBP to add it to your scheme

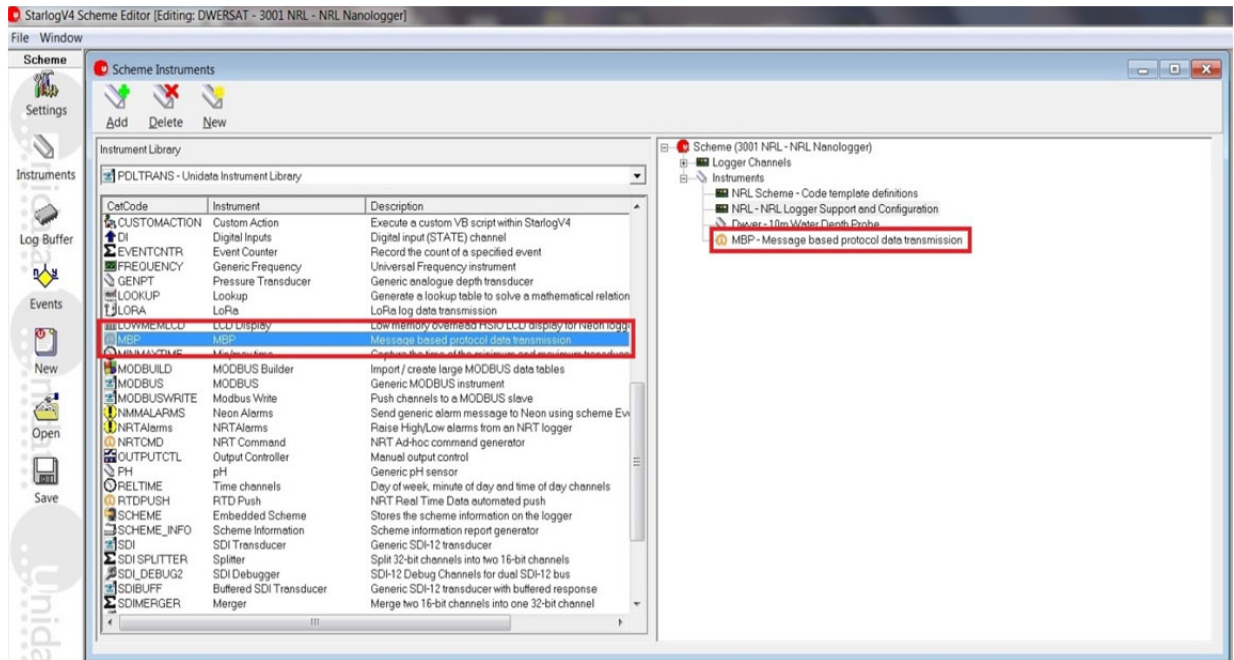

In the instruments window, double click on the MBP setting to open the configuration dialog Set to Automatically Triggered.

MBP Transmission Rate controls how often the NRL will attempt to upload logged data to the Neon Server. This setting is analogous to the Comms Frequency setting in Neon. MPB Transmission Offset is analogous to Comms Offset setting in Neon. Set to the same setting as the UTC offset above for no offset

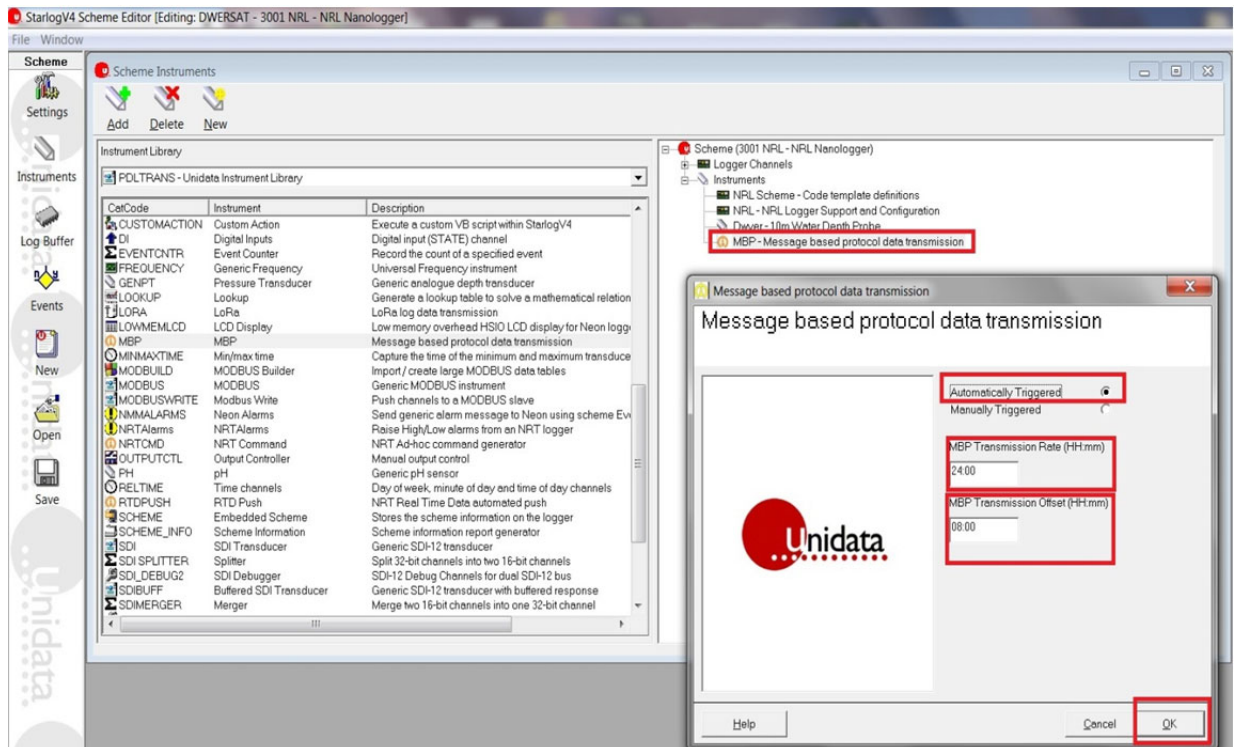

In the above example, the communication frequency will be once every 24 hours. Communication attempt will occur at midnight. If the MBP transmission offset is set to 14 hours, communications attempt would occur at 6AM instead

If the NRL is unsuccessful in its attempt to contact the Neon server, it will try again at the next scheduled communications time. There are currently no retry attempts.

### 1.5.2 Message Based Protocol (MBP) Neon Configuration – Iridium SBD

The relevant settings are found under the Loggers Tab

Set Communications Protocol to Iridium SBD(MBP)

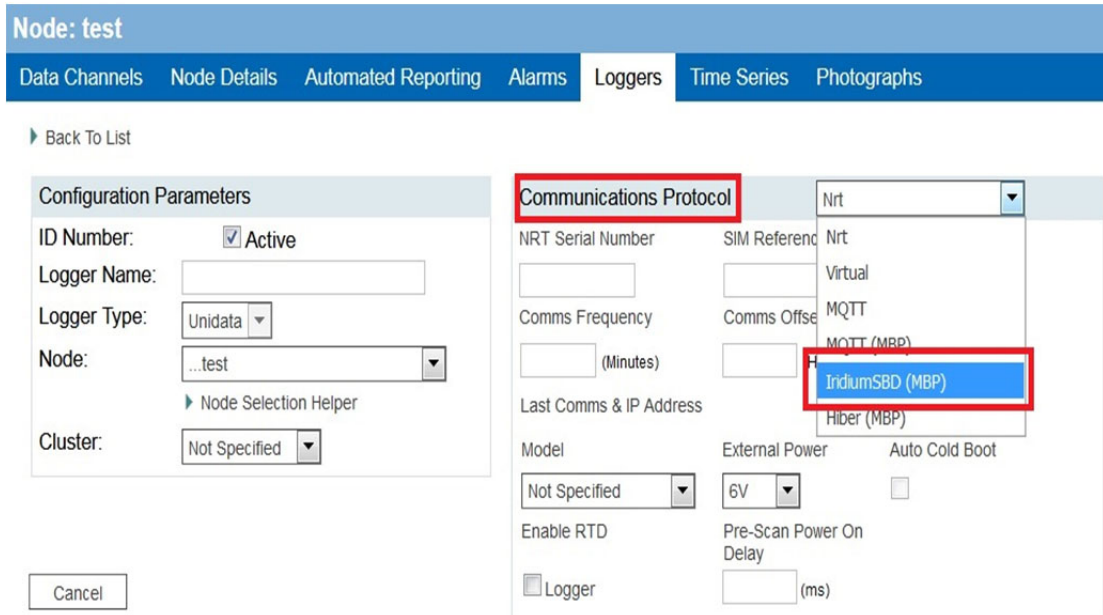

In Device ID / EUI enter the IMEI number found on the label of your product

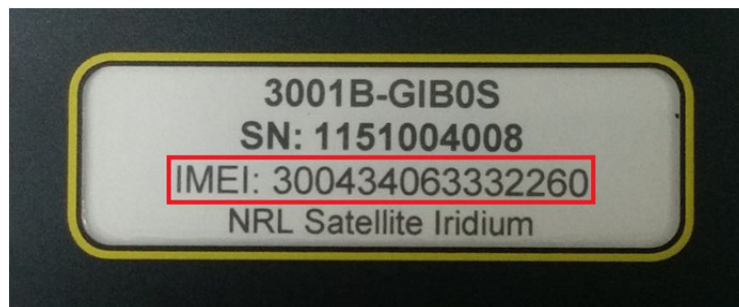

Enter the Comms Frequency

Set the Send Packet Gateway as shown

Enter Gateway Username as Unidata\_Retail

Enter Gateway Password as Unidata\_Retail310

Then click on Browse button to upload the Neon scheme

Select the .NEON file for the scheme created above, then click Upload button, then Save button

Data Channels Node Details Automated Reporting Alarms **Loggers** Time Series Photographs

▶ Back To List ▶ Add New Logger

**Configuration Parameters**

ID Number: 799  Active  Decommission

Logger Name: IridTest

Logger Type: Unidata

Node: ..delete

Cluster: Not Specified

Buttons: Cancel **Save** Delete

**Communications Protocol** IridiumSBD (MBP)

Device ID / EUI: 300434063332260

Comms Frequency: 60 (Minutes) Comms Late Delay: 1800 (Sec)

Send Packet Gateway: https://data.pulsarportal.com/MT/V1/SBD

Gateway Username: Unidata\_Retail Gateway Password: .....

Last Comms

---

Logger **Commands** Logger Registers

**Scheme Files**

NEON Scheme: Browse... No file selected.

Upload  Component Files

**IMPORTANT: The logger must also be programed locally with the scheme.**

**Scheme History**

Files	Status	Created	User
IridTest.XML	Pending	24/10/2019	System Administrator
IridTest.LDR		11:17:57	
IridTest.SXS			

Neon Node Setup complete

### 1.5.3 Message Based Protocol (MBP) Neon Configuration – LoRa WAN

The relevant settings are found under the Loggers Tab

Set Communications Protocol to MQTT(MBP)

Data Channels Node Details Automated Reporting Alarms **Loggers** Time Series Photographs

▶ Back To List ▶ Add New Logger

**Configuration Parameters**

ID Number: 800  Active  Decommission

Logger Name: 1hrL24hrC

Logger Type: Unidata

Node: ..delete

Cluster: Not Specified

Buttons: Cancel **Save** Delete

**Communications Protocol** MQTT (MBP)

Device ID / EUI: 80-00-00-04-00-06-1C

Comms Frequency: 60 (Minutes) Comms Late Delay: 1800 (Sec)

Last Comms

Last RSSI: 0

---

Logger

**Scheme Files**

NEON Scheme: Browse... No file selected.

Upload  Component Files

**IMPORTANT: The logger must also be programed locally with the scheme.**

**Scheme History**

Files	Status	Created	User
1hrL24hrC.XML	Pending	24/10/2019	System Administrator
1hrL24hrC.LDR		11:25:14	
1hrL24hrC.SXS			



In Device ID / EUI enter the Device EUI as shown on the label of your product (including dashes)

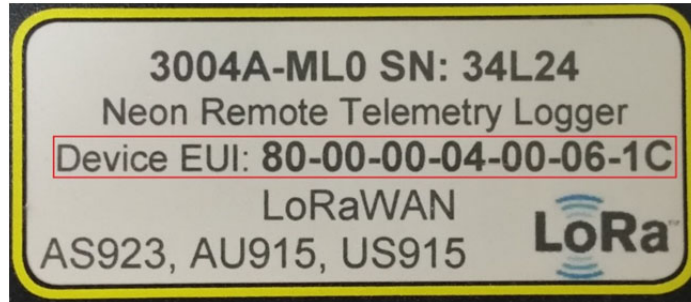

Enter the Comms Frequency

Then click on Browse button to upload the Neon scheme

Select the .NEON file for the scheme created above, then click Upload button, then Save button

Neon Node Setup complete

#### 1.5.4 Program Neon Remote Logger With the Scheme Program

MBP type loggers operate differently to Full Protocol Implementation loggers. The scheme program is still uploaded to the Neon node, but it is for internal use only, and is not downloaded to the logger by the Neon server. The user must program the Neon Remote Logger locally, using Starlog V4 software, and a USB cable. The scheme program used must match the one used in step 1.5.2 above. If any changes are made to the scheme program in the future, the NRL must be reprogrammed locally, and this new scheme program also uploaded to the Neon node for that logger

#### 1.5.5 NRL LoRa Configuration

When using LoRa it is necessary to enter some LoRa network specific setup parameters into the NRL.

These parameters can be entered into the NRL using either the LCD and keypad (if the NRL model has them – refer to section 3.3.2 for details), or using the NRL diagnostics menu. The relevant settings are found in the Setup Menu under the LORA option. The diagnostics menu pin number must be entered first before these settings can be altered.

```

>| LORA
  ABP
  OTA
  FSB
  PN
  DR
  TXDR
  NLCINT
  
```

LoRa nodes can be setup to use OTAA (Over The Air Activation) OR ABP (Activation By Personalisation).

Using **ABP** join mode requires the user to define the following values and input them into both the device and gateway/network server.

- **ADDR:** This is a logical address used to identify the object on the network.

- **NSK (Network Session Key):** Encryption key between the object and the operator used for transmissions and to validate the integrity of messages.
- **ASK or DSK (Application Session Key):** Encryption key between the object and the user (via the application) used for transmissions and to validate the integrity of messages.

Using **OTAA** join mode requires the user to define the following values and input them into both the device and gateway/network server.

- **ID:** This is a unique application identifier used to group objects. This address, 64 bits, is used to classify the peripheral devices by application. This setting can be adjusted.
- **KEY:** This is a secret key shared between the peripheral device and the network. It is used to determine the session keys. This setting can be adjusted.
- **FSB:** This allows configuration of the frequency subbands and is usually a configuration parameter used on US915. This setting is used for channel management of the 64 channels, a value between 1 and 8 is used to configure the end device to use one set of the eight channels, the gateway must be configured with the same setting.
- **PN:** This setting is used for a private or public network connection, default is set to 1 for public connection which is the standard on LoRa networks.
- **DR:** This is the adaptive data rate setting, 0 is disabled and 1 is enabled.
- **TXDR:** Sets the current data rate to use, settings shown below where 0 = DR0, 1 = DR1 etc.

#### **US 915 Data Rates Max Payload (bytes)**

DR0 : 11  
DR1 : 53  
DR2 : 125  
DR3 : 242

#### **AU 915 Data Rates Max Payload (bytes)**

DR0 : 51  
DR1 : 51  
DR2 : 51  
DR3 : 115  
DR4 : 242

#### **AS 923 Data Rates Max Payload (bytes)**

DR0 : 51  
DR1 : 51  
DR2 : 51  
DR3 : 115  
DR4 : 242

- **NLCINT:** This function performs a network link check every “x” number of communications; this allows a check to see if the connection to the gateway is still functional. If the network link check fails then a join request will be sent to the gateway until the join succeeds. The default setting is 10.

## 1.6 NRL Internal Architecture

The NRL Internal architecture is shown below. It contains two discrete sections:

1. A **LOGGER** section where the terminal connects to the field transducers and the logging scheme, scan rates and diagnostics are managed.

The StarlogV4 support software allows a user to generate a logger program (called a scheme) which defines transducer information, logging scan rates, logger interval etc. and various engineering unit definitions. These files are called, for example the LDR and KBD files.

2. A **COMMUNICATOR** section which deals with communications to the server. This section contains, for example, a scheduler component and the modem component, either a Cellular Network modem or a Satellite Network modem. The communicator manages functions such as the reporting interval, the number of communications attempts per communications session, etc.

The StarlogV4 support software allows a user to generate a configuration file for the Communicator section, called an FPO file in which the user sets the required communications parameters.

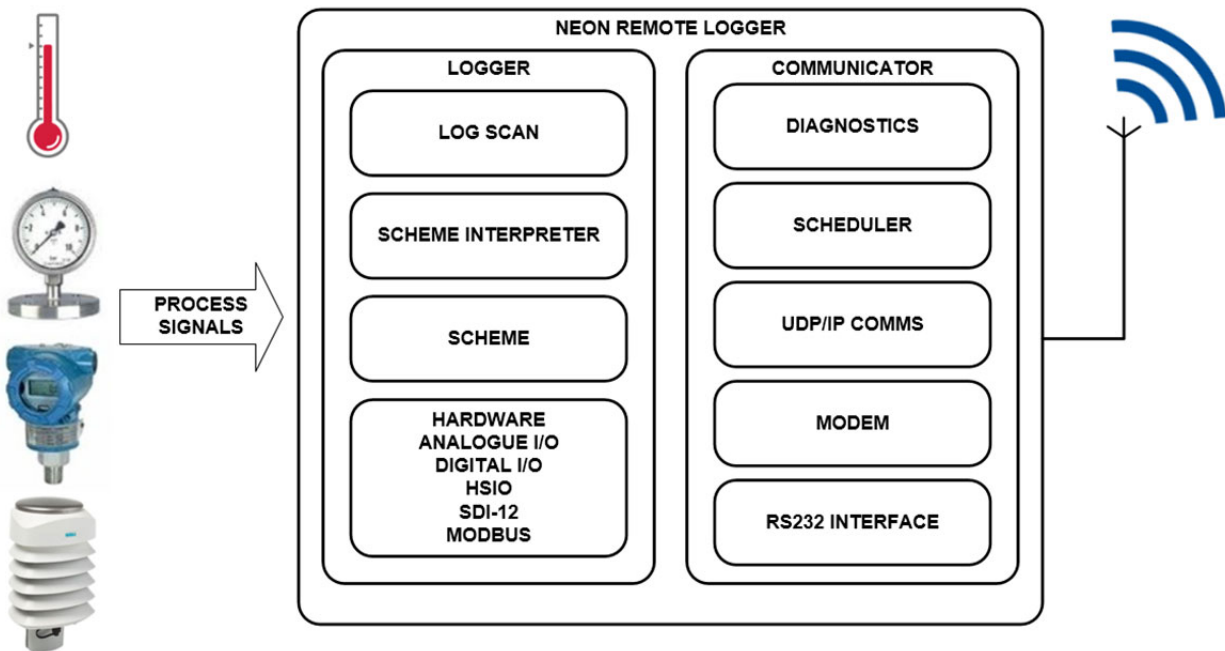

## 1.7 NRL Models

The NRLs come in different sizes and configurations, and while the software architecture remains the same with all models, the larger models have more connectivity and more input channels than the lower models.

There are three main groups:

1. The 3016, 3008 and 3004 are the higher end models with higher connectivity and are housed inside metal enclosures with input terminals exposed on the side, for easy sensor connection.
2. The 3004M models are mid-range models with lower connectivity and are housed inside smaller polycarbonate enclosures or metal enclosures for high IP rating applications.
3. The 3001M and 3001G models are low end models with lower connectivity and are housed inside smaller polycarbonate enclosures.

All of the models and the connectivity details are listed in this manual in the section Summary of Remote Loggers.

## 1.8 NRL Programs (Schemes) and Prologger / Starlogger Emulation Mode

NRL loggers operate in two modes: Native or Emulation.

In Native mode the logger operates much like a Neon Remote Terminal (NRT) and has a memory layout and configuration settings broadly the same. It allows existing NRT schemes to be used immediately without change.

In Emulation mode the logger operates like a Prologger (3016) or Starlogger (all other 3xxx models) with compatible memory layout and configuration options. It is intended to allow the use of existing Prologger or Starlogger schemes immediately and later transition to Native mode.

To access new NRL features requires porting both NRT and Prologger/Starlogger schemes to the new NRL scheme type.

## 1.9 NRL New Features

The NRL offers several new features not available in earlier NRT and Prologger/Starlogger loggers:

- Critical data is stored in non-volatile FRAM, rather than volatile RAM, to allow for faster recovery after power interruptions.
- Improved memory management allows for more complicated scheme programs.
- Floating-point support.
- Support for >16-bit analog channels.
- Support for 32-bit counter channels.
- Support for multiple SDI-12 busses.
- Support for multiple Modbus busses.
- Support for burst transmission of each log record. This is particularly suitable for IoT technologies such as LoRa, microsatellite systems or Iridium Short Burst Data.

## 1.10 NRL Data Storage options

### 1.10.1 Flash

NRLs have internal Flash memory that is used to store internal data, the scheme program, and all logged data.

### 1.10.2 MMC/SD Card

Not currently available, but future updates to NRLs will add support for saving logged data to MMC/SD cards and for loading scheme programs saved to those cards.



### 1.10.3 USB Thumbdrive

Not currently available, but future updates to NRLs will add support for USB thumbdrives with the same functionality intended for MMC/SD cards.

## 2.0 NRL LED INDICATORS

### 2.1 3016, 3008, 3004 “High End”

These loggers have six bi-colour (red/green) LEDs:

Label	Description
Power	Turns on when the NRL performs a scan, typically every few seconds. Green indicates good power voltage. Red indicates the power is low.
Config	Turns on when activity is detected on the USB configuration port, which is used for configuration and local programming/unloading. Red indicates the logger has detected something plugged in, but not communicating. Green indicates successful communication.
Scheme	Turns on every scan when the scheme program is being executed. The colour is under scheme control. By default red indicates the scheme has stopped and is not logging, while green indicates the scheme is running and logging as programmed.
Neon	Turns on when the logger is communicating with the Neon server. Red indicates the logger is attempting to establish a connection, which takes around 10 to 20 seconds. When the connection is successful the LED turns green. When the communication completes (successfully or otherwise) it turns off.
Status	Indicates MMC/SD card activity. Green indicates a card has been detected. Red indicates the card is busy and should not be removed.
USB	This LED is located either on the top and labelled “USB”, or is located next to the “USB Drive” on the side.  Green indicates a USB storage device has been detected. Red indicates the device is busy and should not be removed.

### 2.2 3004M “Mid-Range” and 3001M “Low End”

These loggers have three bi-colour (red/green) LEDs:

Label	Description
PWR	Same as the Power LED described above.
SCHM	Same as the Scheme LED described above.
COMS	A combination of the Config, Neon, and Status LEDs described above. If any of those LEDs would be green, this LED will be green. Otherwise, if any of those LEDs would be red, this LED will be red. If all of those LEDs are off, this LED will be off.

### 2.3 Normal Scheme Indication

In normal operation the Power/PWR LED comes on first, quickly followed by the Scheme/SCHM LED, then both turning off. This occurs at regular scan intervals as specified by the scheme, which can range from one second to many minutes.

At each interval the Power/PWR LED is turned on for the duration of the scan, which is typically less than a second, and is when the various logger inputs are read and the scheme program executed.

The scheme also operates during each scan, after the sensors have been read. While the scheme is executing, the Scheme/SCHM LED is lit. The colour of the LED is under scheme control, but by default green indicates correct operation.

Unless the logger is communicating, no other LEDs will be lit.

### 2.4 Telemetry Indication

When the logger communicates with Neon, the Neon/COMS LED will be lit. It will start red until a connection is established with Neon, at which time it will turn green. When the communication process completes, the LED is turned off.

### 2.5 Direct Connection Indication

If you are using the USB port to directly connect to the logger, then the Config/COMS LED will turn red when the logger detects a cable has been connected. When the logger receives a command it recognises, it will turn the LED green to indicate a successful connection. If no commands are quickly received, usually within half a second, the logger will turn the port off to conserve power. It will also turn the port off when instructed by a connected computer. It will check the port again after a few seconds.

As a result, the LED will blink red when a cable is plugged in, but the software is not communicating. If the software is communicating, the LED will briefly light red before changing to green when the logger received the first command. It will stay green while the software is communicating (for example, updating test displays, or programming or unloading the logger), then turn off when the software is finished.

### 2.6 Firmware Update Indication

While the logger is transferring firmware update data from either Neon, or an MMC/SD card, the logger will continue to operate as normal until the firmware data has been fully downloaded and verified.

Once verified, the firmware data will be flashed, which may take up to 20 seconds. For the duration of that the logger is unable to perform any other operation. All LEDs (except the USB LED) will turn red to indicate the logger is unavailable.

## 3.0 NRL STATUS MENU SCREENS

In the 3000 NRL Family some models are equipped with an LCD Display and keypad as standard, while other models may have a display and keypad as an optional extra.

The logger status screen(s) enables the user to inspect the current status of a range of logger status parameters. To access the logger status screen press the *ENTER* button (if the logger display is sleeping) and then press the *LOGGER STATUS* button on the LCD touch display.

There are two streams of Logger Status data. You can toggle between these by again pressing the *LOGGER STATUS* button. The status values that can be displayed are as below:

Parameter	Details
Logger Name	
NRTID	NRT ID number.
SER#	Logger serial number.
Time / Date	Current logger time & date.
MAIN	Main power supply input voltage.
AUX	Auxiliary power supply input voltage.
RTCC	Internal Real Time Clock battery voltage.
Temp	Current logger internal temperature.
Baro	Current logger barometric pressure (not supported by all models of NRL).
<b>Press DOWN key to advance to next screen(s)</b>	
A00.....A15	Voltages present on analog inputs. Note that these may show spurious values if they are unconnected or not supported by the model of NRL in use.
C0.....C7	Current values stored in logger counter registers. Not all models of NRLs support all eight counter channels. Unsupported channels will read zero.
<b>Press LOGGER STATUS to advance to next screen</b>	
Baro xx.xdegC	Temperature of barometric pressure sensor
Acc xx.xdegC	Temperature of accelerometer sensor
X x.xxxG	Accelerometer X-axis value
Y y.yyyG	Accelerometer Y-axis value
Z z.zzzG	Accelerometer Z-axis value
Orient ooo	Logger orientation value
DS2470BU	Coulomb counter value
Acc -iii uAh	
MSP430 ChipID xxxxxxxxxxxxxxxxxxxx	Processor identifier
ENC424J600 000000:000000	MAC device type MAC address
MAX31826 Addr xxxxxxxxxxxxxxxxxxxx	Internal temperature sensor
DS2470 Addr xxxxxxxxxxxxxxxxxxxx	Internal Coulomb counter address
<b>Press DOWN key to advance to next screen</b>	
LoRa EUI xxxxxxxxxxxxxxxxxxxx	LoRa modem ID
100V001_001~001 mmm dd yyyy hh:mm:ss	Firmware version, build date, build time
MMI V001 mmm dd yyyy hh:mm:ss	LCD panel firmware version, build date, build time

### 3.1 Logger Status Screen Navigation

The Logger Status screen has two pages that can be scrolled using the UP & DOWN keys. Pressing the *LOGGER STATUS* button on the LCD screen will toggle between the two pages. Press ENTER.

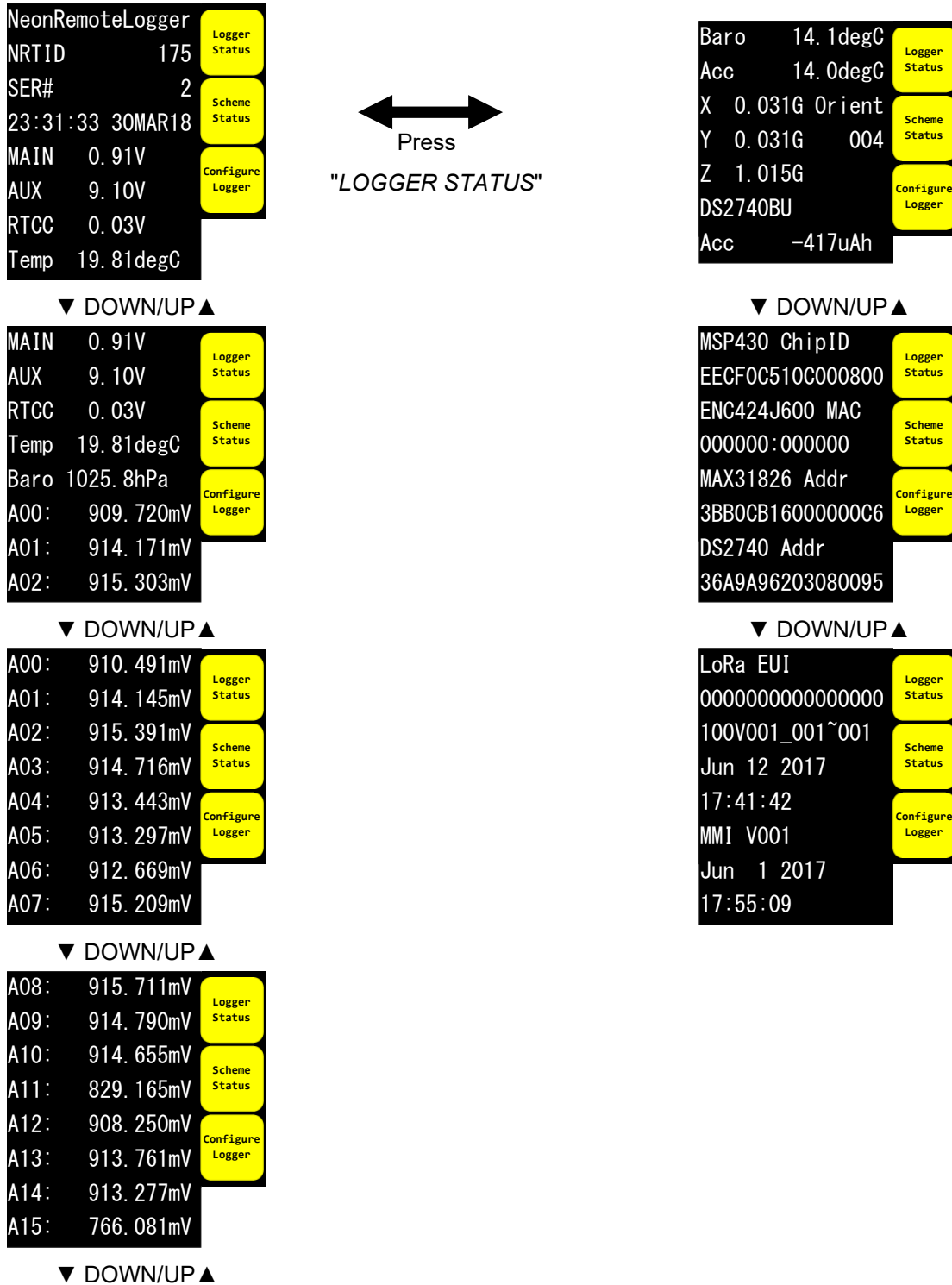

A12:	908.852mV	Logger Status
A13:	915.399mV	
A14:	913.413mV	Scheme Status
A15:	766.925mV	
C0 :	0	Configure Logger
C1 :	0	
C2 :	0	
C3 :	0	

▼ DOWN/UP ▲

C0 :	0	Logger Status
C1 :	0	
C2 :	0	Scheme Status
C3 :	0	
C4 :	0	Configure Logger
C5 :	0	
C6 :	0	
C7 :	0	

### 3.2 Scheme Status Data

The scheme status screen(s) enables the user to view the status of inputs and instruments active under the loaded scheme.

To access the logger status screen either press the *ENTER* button (if the logger display is sleeping) and then the *SCHEME STATUS* button on the LCD touch display.

To scroll through the list of parameters use the ▼ *DOWN* and *UP* ▲ keys.

### 3.3 Configure Logger

Various logger parameters can be configured via the Configure Logger button.

These parameters are divided into three menus;

1. General
2. Comms
3. Inputs

Press the *ENTER* button (if the logger display is sleeping) and then the *CONFIGURE LOGGER* button on the LCD touch screen to enter the configuration menus. Repeated pressing of the *CONFIGURE LOGGER* button will allow access to the three different menus.

To scroll through the list of parameters within each menu use the ▼ *DOWN* and *UP* ▲ keys. To change a parameter the ▼ *DOWN* and *UP* ▲ keys should be used to navigate to the desired parameter. The ◀ *LEFT* and *RIGHT* ▶ keys in combination with the ▼ *DOWN* and *UP* ▲ keys can be used to select and change values.

### 3.3.1 General Configuration Parameters

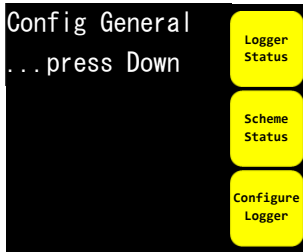

Parameter	Notes
Enter PIN #	Enter the current 4 digit PIN #
Change PIN #	Change the PIN #
Turn display off	Forces the screen to turn off immediately
Reset logger	Reconfigures the logger to factory defaults
Lock display on	Prevents the screen from automatically turning off
Turn logger off	Disables the communications scheduler, instrument scan and scheme interpreter
Set scan rate	
Set FAST	
Set Year	Configure the current time and date
Set Month	
Set Day	
Set Hour	
Set Minute	

### 3.3.2 Communication Parameters

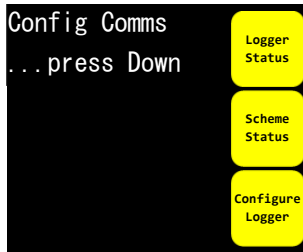

Parameter	Notes
Force Neon comms	Force a communications cycle to occur immediately instead of at the scheduled time.
Initialise NRL	Connects to the Neon Server, downloads the scheme for the configured NRT ID, and starts logging.
NRT ID	A number assigned by the Neon Server that identifies the NRT / NRL. Ranges from 1 through 4,294,967,295.
Set Neon IP	The IP address of the Neon Server.
Ethernet priority	These parameters set the communications priority for the various communications interfaces. A higher number indicates a higher priority. A priority of '0' indicates the interface is not used.
3G/4G SIM1 priority	
3G/4G SIM2 priority	
Serial (Satellite) priority	
Serial (X-Bee) priority	
Set SIM1 APN	Access Point Name and corresponding Username and Password for the SIM1 / SIM2 / Satellite communications interfaces. Access Point Names must be in double-quotes (") otherwise the setting will be treated as a telephone number to connect to.
Set SIM1 User / PW	
Set SIM2 APN	
Set SIM2 User / PW	
Set Satellite APN	
Set Ethernet IP	Static IP address. Set any of this, Gateway or DNS addresses to 0.0.0.0 for DHCP.
Set Ethernet Netmask	Default 255.255.255.0
Set Ethernet Gateway	Static Gateway IP address. Set any of this, IP or DNS addresses to 0.0.0.0 for DHCP.
Set Ethernet DNS	Static DNS IP address. Set any of this, IP or Gateway addresses to 0.0.0.0 for DHCP.
WiFi SSID	WiFi SSID / Password & LoRa Network ID / Key
WiFi Password	
LoRa Mode	ABP(default) or OTA
LoRa ABP NetAddr	ABP Network Address (n/a for OTA)
LoRa ABP NSK/OTA NetID	ABP Network Session Key or OTA Network ID
LoRa ABP DSK/OTA NetKey	ABP Data Session Key or OTA Network Key
LoRa FSB	Frequency Sub-Band (0-9, default 0)
LoRa PN	Private(default) or Public network selection
LoRa DR	Fixed(default) or Adaptive Data Rate
LoRa TXDR	Transmit Data Rate (0-7, default 4)

## 4.0 SUMMARY OF NEON REMOTE LOGGERS

All Neon Remote Loggers routinely collect and log sensor data and periodically connect to a central Neon Web server via an IP network using a push data model to upload the logged data.

There is a large range of models within the Neon Remote Logger range and each model is outlined in the following pages, however the operation of all the models is very similar.

The difference in the models is based on the number of sensor interfaces, the connectivity options and if the customer wishes to have a small display on the unit.

## 4.1 3016 Neon Remote Logger – 16 Analogue Channels

The 3016 Neon Remote Logger (NRL) is self-contained data logger / rtu with 16 high resolution analog channels in a compact case which connects to sensors in the field, collects readings from those sensors and transmits the collected data to a central Neon server, or it can be set up to operate as a stand-alone datalogger / rtu. The 3016 can be configured to transmit data via a cellular 2G / 3G / 4G / LTE network, satellite network like Inmarsat, Iridium SBD or Microsatellite, Wi-Fi network or it can utilise LoRa communication system as its method of sending data from the field to the Neon Server.



### 4.1.1 3016 Specifications

#### Physical specifications

<b>Material:</b>	Powder Coated Aluminium Enclosure
<b>Size:</b>	295mm x 160mm x 40mm (LxWxH)
<b>Weight:</b>	850 grams
<b>Operating Temp:</b>	-20°C to 60°C. Not affected by humidity
<b>Antennae:</b>	Model dependent, external stub/whip/satellite antenna

#### Electrical Specifications

<b>External Power:</b>	9 to 30V DC (provision for dual power inputs)
<b>Current Draw:</b>	<800µA Standby, Max 500mA Active
<b>RTC Backup Battery:</b>	3.6V Li Coin Cell (5 year life)
<b>Instrument Power</b>	12V regulated, 200mA fused, 5V regulated, 100mA fused
<b>Analog Channels:</b>	16 Single ended (max) or 8 Differential (max), 24 bit resolution, 4 user selectable gain ranges, 0 to 5000mV (gain=1) to 0 to 39mV (gain=128)
<b>MODBUS:</b>	2 independent channels, RS485 RTU or ASCII protocol, 57600 baud (max), Functions 01, 02, 03, 04, 05/15, 06/16
<b>SDI-12:</b>	2 independent channels, SDI V1.3 Compliant, instrument and recorder modes supported
<b>Unidata HSIO:</b>	High speed serial interface, 16 channels, bi-directional
<b>Counters:</b>	2 x 16 bit, DC to 20kHz potential free contacts or 0 to 5V DC digital input (C0,C2) 2 x 16 bit, DC to 300Hz potential free contacts or 0 to 5V DC digital input (C1,C3)
<b>Digital Inputs:</b>	4, Low<1.1V, High >2.05V, Max = 5V DC
<b>Digital Outputs:</b>	2, Open Drain FET, 30V DC, 250mA max
<b>Relays:</b>	2, Normally Open and Normally Closed Contacts, 1A 30V DC, 0.5A 125V AC
<b>Configuration Port:</b>	RS232 serial port, 115200 maximum baud rate USB A Port, USB B Port and SD Micro Card, Optional Bluetooth Low Power Wireless interface
<b>Modem Interface:</b>	LoRaWAN AU915, US915, AS923, EU868, Cellular: 2G/3G/4G/LTE Modem, Dual SIM card support Satellite: Inmarsat, Iridium SBD or Microsatellite Modem, Wi-Fi Module
<b>Serial Instrument:</b>	RS232 port, full implementation (all 9 signals available), baud rate 1152000 max
<b>Data Interface:</b>	USB B Port and SD Micro Card
<b>Ethernet Port:</b>	10/100 Mbit
<b>LCD Display:</b>	320 x 240, Colour, Resistive Touch Panel
<b>Keypad:</b>	5 button membrane keypad
<b>Accelerometer:</b>	Senses changes in logger orientation
<b>Barometer:</b>	260-1260hPa Absolute Digital Output

#### Integrated Logger Specifications

<b>Storage memory:</b>	7.5Mbytes Flash (non-volatile), up to 3.75 Million log data points
<b>Memory Expansion:</b>	SD card, micro size, 32Gbyte maximum capacity, up to 16 Billion log data points
<b>Scan rate:</b>	Programmable from 1 second to 5 minutes
<b>Log rate:</b>	Programmable from 1 second to 24 hours
<b>Time clock:</b>	Battery Backed Real Time Clock (RTC), Accuracy +/- 10 seconds/month (non- Neon version), locked to server time clock (Neon version)
<b>CPU:</b>	16 Bit, 20MHz, Ultra Low Power



**3016 – Product Options**

Model Number	Description
3016-000	Neon Remote Logger - Ethernet / 16 Analog Channels / Touch Screen Display
3016-00I	Neon Remote Logger - Inmarsat / 16 Analog Channels / Touch Screen Display
3016-00R	Neon Remote Logger – Iridium SBD / 16 Analog Channels / Touch Screen Display
3016-0L0	Neon Remote Logger – Ethernet and LoRa / 16 Analog Channels / Touch Screen Display
3016-0LI	Neon Remote Logger - Inmarsat and LoRa / 16 Analog Channels / Touch Screen Display
3016-0LR	Neon Remote Logger - Iridium SBD and LoRa / 16 Analog Channels / Touch Screen Display
3016-C00	Neon Remote Logger - Ethernet and 3G/4G / 16 Analog Channels / Touch Screen Display
3016-C0I	Neon Remote Logger - Inmarsat and 3G/4G / 16 Analog Channels / Touch Screen Display
3016-CL0	Neon Remote Logger – Ethernet, 3G/4G and LoRa / 16 Analog Channels / Touch Screen Display

**4.2 3008 Neon Remote Logger – 8 Analogue Channels**

The 3008 Neon Remote Logger (NRL) is self-contained data logger / rtu with 8 high resolution analog channels in a compact case which connects to sensors in the field, collects readings from those sensors and transmits the collected data to a central Neon server, or it can be set up to operate as a stand-alone datalogger / rtu.

The 3008 can be configured to transmit data via a cellular 2G / 3G / 4G / LTE network, satellite network like Inmarsat, Iridium SBD or Microsatellite, Wi-Fi network or it can utilise LoRa communication system as its method of sending data from the field to the Neon Server.

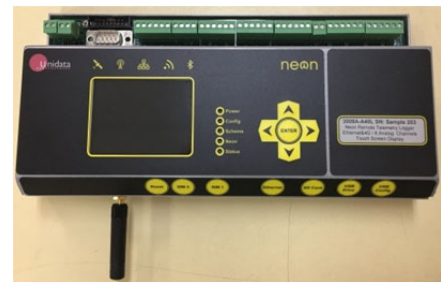

## 4.2.1 3008 Specifications

### Physical specifications

<b>Material:</b>	Powder Coated Aluminium Enclosure
<b>Size:</b>	282mm x 122mm x 40mm (LxWxH)
<b>Weight:</b>	650 grams
<b>Operating Temp:</b>	-20°C to 60°C. Not affected by humidity
<b>Antennae:</b>	Model dependent, external stub/whip/satellite antenna

### Electrical Specifications

<b>External Power:</b>	9 to 30V DC (provision for dual power inputs)
<b>Current Draw:</b>	<800µA Standby, Max 500mA Active
<b>RTC Backup Battery:</b>	3.6V Li Coin Cell (5 year life)
<b>Instrument Power</b>	12V regulated, 200mA fused, 5V regulated, 100mA fused
<b>Analog Channels:</b>	8 Single ended (max) or 4 Differential (max) 24 bit resolution, 4 user selectable gain ranges, 0 to 5000mV (gain=1) to 0 to 39mV (gain=128)
<b>MODBUS:</b>	2 independent channels, RS485 RTU or ASCII protocol, 57600 baud (max), Functions 01, 02, 03, 04, 05/15, 06/16
<b>SDI-12:</b>	2 independent channels, SDI V1.3 Compliant, instrument and recorder modes supported
<b>Counters:</b>	2 x 16 bit, DC to 20kHz potential free contacts or 0 to 5V DC digital input (C0,C2) 2 x 16 bit, DC to 300Hz potential free contacts or 0 to 5V DC digital input (C1,C3)
<b>Digital Outputs:</b>	1 x Open Drain FET, 30V DC, 250mA max
<b>Relays:</b>	2, Normally Open and Normally Closed Contacts, 1A 30V DC, 0.5A 125V AC
<b>Configuration Port:</b>	USB A Port, USB B Port and SD Micro Card, Optional Bluetooth Low Power Wireless interface
<b>Modem Interface:</b>	LoRaWAN AU915, US915, AS923, EU868, Cellular: 2G/3G/4G/LTE Modem, Dual SIM card support Satellite: Inmarsat, Iridium SBD or Microsatellite Modem, Wi-Fi Module
<b>Serial Instrument:</b>	RS232 port, full implementation (all 9 signals available), baud rate 1152000 max
<b>Data Interface:</b>	USB B Port and SD Micro Card
<b>Ethernet Port:</b>	10/100 Mbit
<b>LCD Display:</b>	320 x 240, Colour, Resistive Touch Panel
<b>Keypad:</b>	5 button membrane keypad
<b>Accelerometer:</b>	Senses changes in logger orientation
<b>Barometer:</b>	260-1260hPa Absolute Digital Output

### Integrated Logger Specifications

<b>Storage memory:</b>	7.5Mbytes Flash (non-volatile), up to 3.75 Million log data points
<b>Memory Expansion:</b>	SD card, micro size, 32Gbyte maximum capacity, up to 16 Billion log data points
<b>Scan rate:</b>	Programmable from 1 second to 5 minutes
<b>Log rate:</b>	Programmable from 1 second to 24 hours
<b>Time clock:</b>	Battery Backed Real Time Clock (RTC), Accuracy +/- 10 seconds/month (non- Neon version), locked to server time clock (Neon version)
<b>CPU:</b>	16 Bit, 20MHz, Ultra Low Power

### 3008 – Product Options

Model Number	Description
3008-000	Neon Remote Logger - Ethernet / 8 Analog Channels / Touch Screen Display
3008-00I	Neon Remote Logger - Inmarsat / 8 Analog Channels / Touch Screen Display
3008-00R	Neon Remote Logger – Iridium SBD / 8 Analog Channels / Touch Screen Display
3008-0L0	Neon Remote Logger – Ethernet and LoRa / 8 Analog Channels / Touch Screen Display
3008-0LI	Neon Remote Logger - Inmarsat and LoRa / 8 Analog Channels / Touch Screen Display
3008-0LR	Neon Remote Logger - Iridium SBD and LoRa / 8 Analog Channels / Touch Screen Display
3008-C00	Neon Remote Logger - Ethernet and 3G/4G / 8 Analog Channels / Touch Screen Display
3008-C0I	Neon Remote Logger - Inmarsat and 3G/4G / 8 Analog Channels / Touch Screen Display
3008-CL0	Neon Remote Logger – Ethernet, 3G/4G and LoRa / 8 Analog Channels / Touch Screen Display

### 4.3 3004/3006 Neon Remote Logger – 4 Analogue Channels

The 3004/3006 Neon Remote Logger NRL is small self-contained data logger / rtu with 4 / 6 high resolution analog channels in a compact case which connects to sensors in the field, collects readings from those sensors and either transmits the collected data to a central server via either cellular 2G / 3G / 4G / LTE network, Iridium SBD, Ethernet or can be used as a stand-alone datalogger / rtu.



#### 4.3.1 3004/3006 Specifications

##### Physical specifications

<b>Material:</b>	Powder Coated Aluminium Enclosure
<b>Size:</b>	182mm x 110mm x 34mm (LxWxH)
<b>Weight:</b>	400 grams
<b>Operating Temp:</b>	-20°C to 60°C. Not affected by humidity
<b>Antennae:</b>	Model dependent, external stub/whip/satellite antenna

##### Electrical Specifications

<b>External Power:</b>	9 to 30V DC (provision for dual power inputs)
<b>Current Draw:</b>	<800µA Standby, Max 500mA Active
<b>RTC Backup Battery:</b>	3.6V Li Coin Cell (5 year life)
<b>Instrument Power</b>	5V regulated, 100mA fused
<b>Analog Channels 3004:</b>	4 Single ended (max) or 2 Differential (max) 24 bit resolution, 4 user selectable gain ranges, 0 to 5000mV (gain=1) to 0 to 39mV (gain=128)
<b>Analog Channels 3006:</b>	6 Single ended (max) or 3 Differential (max) 24 bit resolution, 4 user selectable gain ranges, 0 to 5000mV (gain=1) to 0 to 39mV (gain=128)
<b>MODBUS:</b>	1 independent channel, RS485 RTU or ASCII protocol, 57600 baud (max), Functions 01, 02, 03, 04, 05/15, 06/16
<b>SDI-12:</b>	1 independent channel, SDI V1.3 Compliant, instrument and recorder modes supported
<b>Counters 3004: 4</b>	2 x 16 bit, DC to 20kHz potential free contacts or 0 to 5V DC digital input (C0,C2) 2 x 16 bit, DC to 300Hz potential free contacts or 0 to 5V DC digital input (C1,C3)
<b>Counters 3006: 2</b>	1 x 16 bit, DC to 20kHz potential free contacts or 0 to 5V DC digital input (C0) 1 x 16 bit, DC to 300Hz potential free contacts or 0 to 5V DC digital input (C1)
<b>Digital Outputs:</b>	1 x Open Drain FET, 30V DC, 250mA max
<b>Relays:</b>	1, Normally Open and Normally Closed Contacts, 1A 30V DC, 0.5A 125V AC
<b>Configuration Port:</b>	USB A Port, USB B Port and SD Micro Card
<b>Modem Interface:</b>	Cellular: 2G/3G/4G/LTE Modem, Single SIM card support or Iridium SBD or Ethernet
<b>Data Interface:</b>	USB B Port and SD Micro Card
<b>LCD Display Optional:</b>	320 x 240, Colour, Resistive Touch Panel
<b>Keypad Optional:</b>	5 button membrane keypad
<b>Accelerometer:</b>	Senses changes in logger orientation
<b>Barometer:</b>	260-1260hPa Absolute Digital Output

##### Integrated Logger Specifications

<b>Storage memory:</b>	7.5Mbytes Flash (non-volatile), up to 3.75 Million log data points
<b>Memory Expansion:</b>	SD card, micro size, 32Gbyte maximum capacity, up to 16 Billion log data points
<b>Scan rate:</b>	Programmable from 1 second to 5 minutes
<b>Log rate:</b>	Programmable from 1 second to 24 hours
<b>Time clock:</b>	Battery Backed Real Time Clock (RTC), Accuracy +/- 10 seconds/month (non- Neon version), locked to server time clock (Neon version)
<b>CPU:</b>	16 Bit, 20MHz, Ultra Low Power

**3004 – Product Options**

<b>Model Number</b>	<b>Description</b>
3004-00	Neon Remote Logger - 4 Analog Channels
3004-C0	Neon Remote Logger – 3G/4G / 4 Analog Channels
3004-0L	Neon Remote Logger - 4 Analog Channels / Touch Screen Display
3004-CL	Neon Remote Logger - 3G/4G / 4 Analog Channels / Touch Screen Display

Other connectivity options available on request

#### 4.4 3004/6-M Neon Remote Logger

The 3004M/3006M Neon Remote Logger Cellular Neon Remote Logger, housed in a polycarbonate case which has a smaller form factor than the standard metal enclosure 3004.

It utilises either Cellular 2G/3G/4G/LTE phone networks, Ethernet, Iridium SBD, Microsatellite or LoRaWAN as its method of sending sensor data from the field to the Neon Server.



is a

##### 4.4.1 3004/6-MC/E/H//L Specifications

###### Physical specifications

<b>Material:</b>	Polycarbonate
<b>Size:</b>	190mm x 80mm x 55mm (LxWxH)
<b>Weight:</b>	300 grams
<b>Operating Temp:</b>	-20°C to 60°C. Not affected by humidity
<b>Antennae:</b>	Model dependent, external stub/whip/satellite antenna

###### Electrical Specifications

<b>External Power:</b>	9 to 30V DC (provision for dual power inputs)
<b>Current Draw:</b>	<50µA Standby
<b>RTC Backup Battery:</b>	3.6V Li Coin Cell (5 year life)
<b>Internal Power:</b>	3.6V Lithium D Cell
<b>Instrument Power:</b>	5V, 12V or 18V regulated, 80mA (user selectable)
<b>Instrument Ref Voltage :</b>	5V 10mA Max
<b>Analog Channels 3004:</b>	4 Single ended (max) or 2 Differential (max) 24 bit resolution, 4 user selectable gain ranges, 0 to 5000mV (gain=1) to 0 to 39mV (gain=128)
<b>Analog Channels 3006:</b>	6 Single ended (max) or 3 Differential (max) 24 bit resolution, 4 user selectable gain ranges, 0 to 5000mV (gain=1) to 0 to 39mV (gain=128)
<b>MODBUS:</b>	1 independent channel, RS485 RTU or ASCII protocol, 57600 baud (max), Functions 01, 02, 03, 04, 05/15, 06/16
<b>SDI-12:</b>	1 independent channel, SDI V1.3 Compliant, instrument and recorder modes supported
<b>Unidata HSIO:</b>	High speed serial interface, 16 channels, bi-directional
<b>Counters 3004: 4</b>	2 x 16 bit, DC to 20kHz potential free contacts or 0 to 5V DC digital input (C0,C2) 2 x 16 bit, DC to 300Hz potential free contacts or 0 to 5V DC digital input (C1,C3)
<b>Counters 3006: 2</b>	1 x 16 bit, DC to 20kHz potential free contacts or 0 to 5V DC digital input (C0) 1 x 16 bit, DC to 300Hz potential free contacts or 0 to 5V DC digital input (C1)
<b>Digital Outputs:</b>	1 x Open Drain FET, 30V DC, 250mA max
<b>Configuration Port:</b>	USB B Port and SD Micro Card
<b>Modem Interface:</b>	Available Options , Cellular: 2G/3G/4G/LTE Modem, Single SIM card support Iridium SBD, Ethernet, Microsatellite, LoRaWAN AU915, US915, AS923, EU868
<b>Accelerometer:</b>	Senses changes in logger orientation
<b>Barometer:</b>	260-1260hPa Absolute Digital Output

###### Integrated Logger Specifications

<b>Storage memory:</b>	7.5Mbytes Flash (non-volatile), up to 3.75 Million log data points
<b>Memory Expansion:</b>	SD card, micro size, 32Gbyte maximum capacity, up to 16 Billion log data points
<b>Scan rate:</b>	Programmable from 1 second to 5 minutes
<b>Log rate:</b>	Programmable from 1 second to 24 hours
<b>Time clock:</b>	Battery Backed Real Time Clock (RTC), Accuracy +/- 10 seconds/month (non- Neon version), locked to server time clock (Neon version)
<b>CPU:</b>	16 Bit, 20MHz, Ultra Low Power

3004/6 – M Product Options

Series	Model	Description
M0	3004-M000	4 Channel NRL No Modem No Batteries
	3004-M0B0	4 Channel NRL No Modem with Lithium Battery
	3006-M000	6 Channel NRL No Modem No Batteries
	3006-M0B0	6 Channel NRL No Modem with Lithium Battery
MC	3004-MC00	4 Channel NRL 3G/4G Modem No Batteries
	3004-MCB0	4 Channel NRL 3G/4G Modem with Lithium Battery
	3006-MC00	6 Channel NRL 3G/4G Modem No Batteries
	3006-MCB0	6 Channel NRL 3G/4G Modem with Lithium Battery
ME	3004-ME00	4 Channel NRL Ethernet No Batteries
	3004-MEB0	4 Channel NRL Ethernet with Lithium Battery
	3006-ME00	6 Channel NRL Ethernet No Batteries
	3006-MEB0	6 Channel NRL Ethernet with Lithium Battery
MH	3004-MH00	4 Channel NRL Microsatellite No Batteries
	3004-MHB0	4 Channel NRL Microsatellite with Lithium Battery
	3006-MH00	6 Channel NRL Microsatellite No Batteries
	3006-MHB0	6 Channel NRL Microsatellite with Lithium Battery
MI	3004-MI00	4 Channel NRL Iridium SBD No Batteries
	3004-MIB0	4 Channel NRL Iridium SBD with Lithium Battery
	3006-MI00	6 Channel NRL Iridium SBD No Batteries
	3006-MIB0	6 Channel NRL Iridium SBD with Lithium Battery
ML	3004-ML00	4 Channel NRL LoRa No Batteries
	3004-MLB0	4 Channel NRL LoRa with Lithium Battery
	3006-ML00	6 Channel NRL LoRa No Batteries
	3006-MLB0	6 Channel NRL LoRa with Lithium Battery

4.5 3001- M or G C/H//L NRL Cellular, LoRa, Iridium SBD or Microsatellite

The 3001M Nano Logger or 3001G Bore Case Logger is a Neon Remote Logger in the M/G range that is designed for connecting to a single sensor. It can be configured to use either Cellular, LoRa, Iridium or Microsatellite networks as its method of sending sensor data from the field to the Neon Server. Difference between 3001M and 3001G is in the enclosure size and probe interface connector type. The variants are driven by different customer application requirements and especially different instrument mounting arrangements.

3001M:



3001G:





3001M Optional Mounting Housing:



3001G Optional Mounting Bracket:



#### 4.5.1 3001- M or G C/H//L Specifications

##### Physical specifications

<b>Material:</b>	Polycarbonate
<b>Enclosure Size:</b>	<b>M:</b> 116mm x 91mm x 83mm, <b>G:</b> 120mm x 85mm x 71mm (LxWxH)
<b>Weight:</b>	300 grams
<b>Operating Temp:</b>	-20°C to 60°C. Not affected by humidity
<b>Antennae:</b>	Model dependent, external stub/whip/satellite antenna

##### Electrical Specifications

<b>External Power:</b>	9 to 30V DC (provision for dual power inputs)
<b>Current Draw:</b>	<50µA Standby
<b>RTC Backup Battery:</b>	3.6V Li Coin Cell (5 year life)
<b>Internal Power:</b>	2 x 3.6V Lithium D Cell
<b>Instrument Power:</b>	15V, (80mA max) or 18V (60mA max) regulated, (user selectable)
<b>Instrument Ref Voltage:</b>	5V 10mA Max
<b>Analog Channels:</b>	1 Single ended (0-2.5V DC) with 12 bit resolution
<b>MODBUS:</b>	1 independent channel, RS485 RTU or ASCII protocol, 57600 baud (max), Functions 01, 02, 03, 04, 05/15, 06/16
<b>SDI-12:</b>	1 independent channel, SDI V1.3 Compliant, instrument and recorder modes supported
<b>Counters:</b>	1 x 16 bit, DC to 20kHz potential free contacts or 0 to 5V DC digital input (C0)
<b>Configuration Port:</b>	USB B Micro Port and SD Micro Card
<b>Modem Interface:</b>	Available Options , Cellular: 2G/3G/4G/LTE Modem, Single SIM card support Iridium SBD, Ethernet, Microsatellite, LoRaWAN AU915, US915, AS923, EU868
<b>Barometer:</b>	260-1260hPa Absolute Digital Output
<b>Sensor Connector</b>	7 Pin SQL Connector or 7 Pin M12 (IP68) Connector or Insitu Connector (Custom) Mating cable mount connector is included with each option

##### Integrated Logger Specifications

<b>Storage memory:</b>	7.5Mbytes Flash (non-volatile), up to 3.75 Million log data points
<b>Memory Expansion:</b>	SD card, micro size, 32Gbyte maximum capacity, up to 16 Billion log data points
<b>Scan rate:</b>	Programmable from 1 second to 5 minutes
<b>Log rate:</b>	Programmable from 1 second to 24 hours
<b>Time clock:</b>	Battery Backed Real Time Clock (RTC), Accuracy +/- 10 seconds/month (non- Neon version), locked to server time clock (Neon version)
<b>CPU:</b>	16 Bit, 20MHz, Ultra Low Power

#### 3001-MC/L//H – Product Options

Model Number	Description
3001-MCB0	Neon Remote Nano Logger Nano Cellular with two Lithium Batteries
3001-MLB0	Neon Remote Nano Logger LoRa with two Lithium Batteries
3001-MIB0	Neon Remote Nano Logger Iridium SBD with two Lithium Batteries
3001-MHB0	Neon Remote Nano Logger Microsatellite with two Lithium Batteries

The optional 3901A Lithium Battery Pack can be connected to 3001M or 3001G, that extends the battery capacity by 26Ahr. Multiple additional battery packs can be daisy chained together to further extend the battery capacity.



### 4.5.2 3901A Lithium Battery Pack Specifications

**Physical specifications**

Material:	Polycarbonate
Size:	120mm x 85mm x 71mm (LxWxH)
Weight:	300 grams

**Electrical Specifications**

Voltage:	3.6V DC
Cell Capacity:	26Ahr



## 5.0 CONNECTIONS

This section provides brief descriptions of available connections/terminations for all 3000 range loggers. The tables below list each termination with a brief description.

### 5.1 3016 Neon Remote Logger – Connections/Terminations

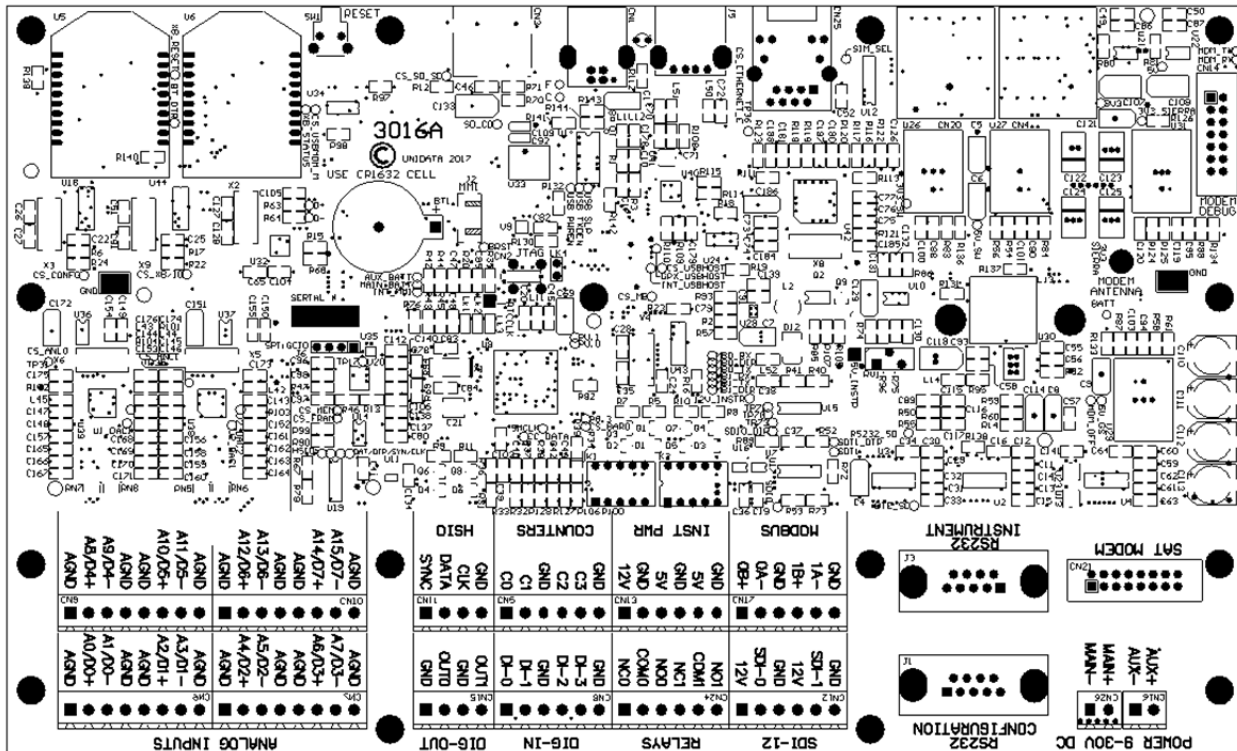

Terminal	Connection	Description
SAT MODEM		Globalstar Satellite Connection
POWER 9-30VDC	AUX+	External 9V to 30VDC Power Supply +
	AUX-	External 9V to 30VDC Power Supply -
POWER 9-30VDC	MAIN+	External 9V to 30VDC Power Supply +
	MAIN-	External 9V to 30VDC Power Supply -
CONFIGURATION	RS232	Logger Configuration RS232 (Female) Serial Port
INSTRUMENT	RS232	Smart Instrument Connection RS232 (Male) Serial Port
SDI-12	GND (1)	Ground SDI-12 Channel 1
	SDI-1	SDI-12 Signal Channel 1
	12V (1)	SDI-12 12V Channel 1
	GND (0)	Ground SDI-12 Channel 0
	SDI-0	SDI-12 Signal Channel 0
	12V (0)	SDI-12 12V Channel 1
MODBUS	GND 1	Ground MODBUS Channel 1
	1A-	MODBUS Channel 1 A-
	1B+	MODBUS Channel 1 B+
	GND 0	Ground MODBUS Channel 0
	0A-	MODBUS Channel 0 A-
	0B+	MODBUS Channel 0 B+
RELAYS	NO1	Normally open 1 1A 30Vdc, 0.5A 125VAC
	COM1	Common 1
	NC1	Normally closed 1 1A 30Vdc, 0.5A 125VAC
	NO0	Normally open 0 1A 30Vdc, 0.5A 125VAC
	COM0	Common 0
	NC0	Normally closed 0 1A 30Vdc, 0.5A 125VAC
INST PWR	GND	Ground
	5V	5V regulated 100mA fused
	GND	Ground
	5V	5V regulated 100mA fused
	GND	Ground
	12V	12V regulated 200mA fused
DIG-IN	GND	Ground
	DI-3	Digital Input 3, Low<1.1V, High>2.05V, Max = 5V DC
	DI-2	Digital Input 2, Low<1.1V, High>2.05V, Max = 5V DC
	GND	Ground
	DI-1	Digital Input 1, Low<1.1V, High>2.05V, Max = 5V DC
	DI-0	Digital Input 0, Low<1.1V, High>2.05V, Max = 5V DC
COUNTERS	GND	Ground
	C3	16 bit, DC to 32Hz potential free contacts or 0 to 5VDC
	C2	16 bit, DC to 32Hz potential free contacts or 0 to 5VDC
	GND	Ground
	C1	16 bit, DC to 32Hz potential free contacts or 0 to 5VDC
	C0	16 bit, DC to 320Hz potential free contacts or 0 to 5VDC
DIG-OUT	OUT1	Output 1 Open Drain FET 30V DC,, 250mA max
	GND	Ground
	OUT0	Output0 Open Drain FET 30V DC,, 250mA max
HSIO	GND	HSIO Ground
	CLK	HSIO Clock
	DATA	HSIO Data
	SYNC	HSIO SYNC

<table border="1" style="display: inline-table; vertical-align: middle;"> <tr> <td>AGND</td><td>●</td><td>AGND</td><td>●</td></tr> <tr> <td>A15/D7-</td><td>●</td><td>A7/D3-</td><td>●</td></tr> <tr> <td>A14/D7+</td><td>●</td><td>A6/D3+</td><td>●</td></tr> <tr> <td>AGND</td><td>●</td><td>AGND</td><td>●</td></tr> <tr> <td>AGND</td><td>●</td><td>AGND</td><td>●</td></tr> <tr> <td>A13/D6-</td><td>●</td><td>A5/D2-</td><td>●</td></tr> <tr> <td>A12/D6+</td><td>●</td><td>A4/D2+</td><td>●</td></tr> <tr> <td>AGND</td><td>■</td><td>AGND</td><td>■</td></tr> <tr> <td>AGND</td><td>●</td><td>AGND</td><td>●</td></tr> <tr> <td>A11/D5-</td><td>●</td><td>A3/D1-</td><td>●</td></tr> <tr> <td>A10/D5+</td><td>●</td><td>A2/D1+</td><td>●</td></tr> <tr> <td>AGND</td><td>●</td><td>AGND</td><td>●</td></tr> <tr> <td>AGND</td><td>●</td><td>AGND</td><td>●</td></tr> <tr> <td>A9/D4-</td><td>●</td><td>A1/D0-</td><td>●</td></tr> <tr> <td>A8/D4+</td><td>●</td><td>A0/D0+</td><td>●</td></tr> <tr> <td>AGND</td><td>■</td><td>AGND</td><td>■</td></tr> </table>				AGND	●	AGND	●	A15/D7-	●	A7/D3-	●	A14/D7+	●	A6/D3+	●	AGND	●	AGND	●	AGND	●	AGND	●	A13/D6-	●	A5/D2-	●	A12/D6+	●	A4/D2+	●	AGND	■	AGND	■	AGND	●	AGND	●	A11/D5-	●	A3/D1-	●	A10/D5+	●	A2/D1+	●	AGND	●	AGND	●	AGND	●	AGND	●	A9/D4-	●	A1/D0-	●	A8/D4+	●	A0/D0+	●	AGND	■	AGND	■	Terminal	Connection	Description
AGND	●	AGND	●																																																																			
A15/D7-	●	A7/D3-	●																																																																			
A14/D7+	●	A6/D3+	●																																																																			
AGND	●	AGND	●																																																																			
AGND	●	AGND	●																																																																			
A13/D6-	●	A5/D2-	●																																																																			
A12/D6+	●	A4/D2+	●																																																																			
AGND	■	AGND	■																																																																			
AGND	●	AGND	●																																																																			
A11/D5-	●	A3/D1-	●																																																																			
A10/D5+	●	A2/D1+	●																																																																			
AGND	●	AGND	●																																																																			
AGND	●	AGND	●																																																																			
A9/D4-	●	A1/D0-	●																																																																			
A8/D4+	●	A0/D0+	●																																																																			
AGND	■	AGND	■																																																																			
ANALOG INPUTS	AGND	AGND	Analog Ground																																																																			
	A7/D3-	A7 +ve single (D3 -ve differential)																																																																				
	A6/D3+	A6 +ve single (D3 +ve differential)																																																																				
	AGND	AGND	Analog Ground																																																																			
	AGND	AGND	Analog Ground																																																																			
	A5/D2-	A5 +ve single (D2 -ve differential)																																																																				
	A4/D2+	A4 +ve single (D2 +ve differential)																																																																				
	AGND	AGND	Analog Ground																																																																			
ANALOG INPUTS	AGND	AGND	Analog Ground																																																																			
	A15/D7-	A15 +ve single (D7 -ve differential)																																																																				
	A14/D7+	A14 +ve single (D7 +ve differential)																																																																				
	AGND	AGND	Analog Ground																																																																			
	AGND	AGND	Analog Ground																																																																			
	A13/D6-	A13 +ve single (D6 -ve differential)																																																																				
	A12/D6+	A12 +ve single (D6 +ve differential)																																																																				
ANALOG INPUTS	AGND	AGND	Analog Ground																																																																			
	A3/D1-	A3 +ve single (D1 -ve differential)																																																																				
	A2/D1+	A2 +ve single (D1 +ve differential)																																																																				
	AGND	AGND	Analog Ground																																																																			
	AGND	AGND	Analog Ground																																																																			
	A1/D0-	A1 +ve single (D0 -ve differential)																																																																				
	A0/D0+	A0 +ve single (D0 +ve differential)																																																																				
ANALOG INPUTS	AGND	AGND	Analog Ground																																																																			
	A11/D5-	A11 +ve single (D5 -ve differential)																																																																				
	A10/D5+	A10 +ve single (D5 +ve differential)																																																																				
	AGND	AGND	Analog Ground																																																																			
	AGND	AGND	Analog Ground																																																																			
	A9/D4-	A9 +ve single (D4 -ve differential)																																																																				
	A8/D4+	A8 +ve single (D4 +ve differential)																																																																				
AGND	AGND	Analog Ground																																																																				

## 5.2 3008 Neon Remote Logger – Connections/Terminations

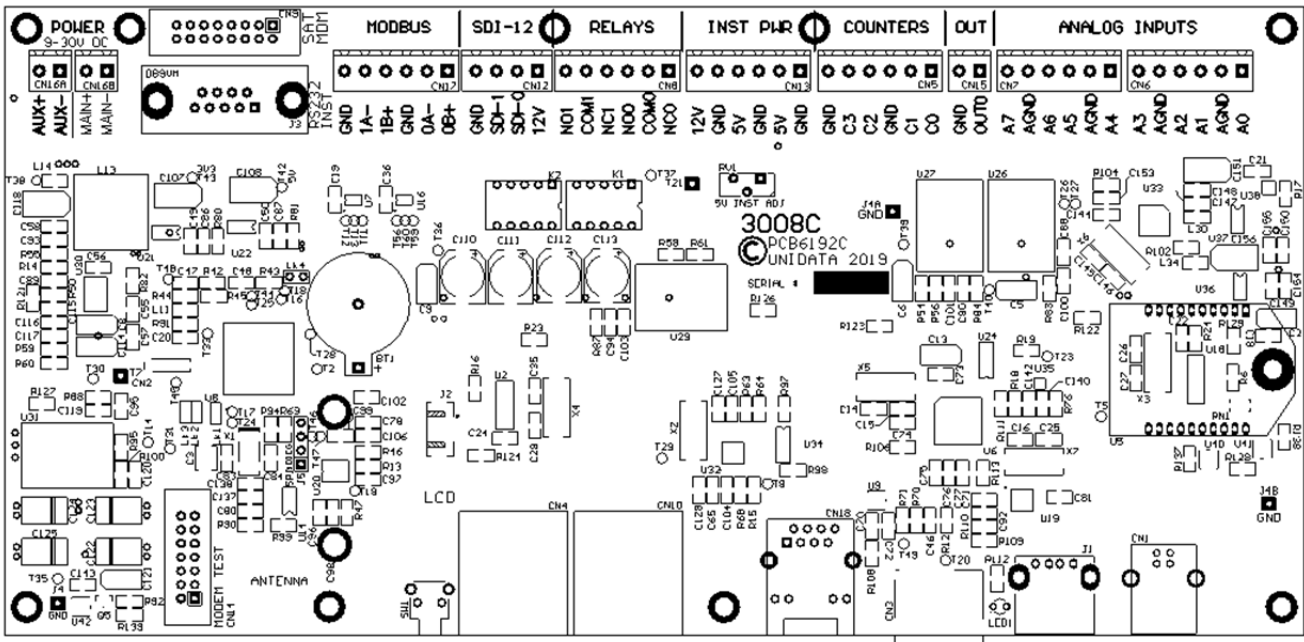

Terminal	Connection	Description
SAT MODEM		Globalstar Satellite Connection
POWER 9-30VDC	AUX+	External 9V to 30VDC Power Supply +
	AUX-	External 9V to 30VDC Power Supply -
POWER 9-30VDC	MAIN+	External 9V to 30VDC Power Supply +
	MAIN-	External 9V to 30VDC Power Supply -
INSTRUMENT		Smart Instrument Connection RS232 (Male) Serial Port
MODBUS	GND 1	Ground MODBUS Channel 1
	1A-	MODBUS Channel 1 A-
	1B+	MODBUS Channel 1 B+
	GND 0	Ground MODBUS Channel 0
	0A-	MODBUS Channel 0 A-
SDI-12	0B+	MODBUS Channel 0 B+
	GND (0 & 1)	Ground SDI-12 Channel 0 and 1
	SDI-1	SDI-12 Signal Channel 1
	12V (0 & 1)	SDI-12 12V Channel 0 and 1
	SDI-0	SDI-12 Signal Channel 0
RELAYS	NO0	Normally open 0 1A 30Vdc, 0.5A 125VAC
	COM0	Common 0
	NC0	Normally closed 0 1A 30Vdc, 0.5A 125VAC
	NO1	Normally open 1 1A 30Vdc, 0.5A 125VAC
	COM1	Common 1
INST PWR	NC1	Normally closed 1 1A 30Vdc, 0.5A 125VAC
	12V	12V regulated 200mA fused
	GND	Ground
	5V	5V regulated 100mA fused
	GND	Ground
COUNTERS	5V	5V regulated 100mA fused
	GND	Ground
	C3	16 bit, DC to 32Hz potential free contacts or 0 to 5VDC
	C2	16 bit, DC to 32Hz potential free contacts or 0 to 5VDC
	C1	16 bit, DC to 32Hz potential free contacts or 0 to 5VDC
OUT	C0	16 bit, DC to 320Hz potential free contacts or 0 to 5VDC
	GND	Ground
	OUT0	Digital Output0 Open Drain FET 30V DC, 250mA max
	A7	A7 +ve single (D3 -ve differential)
	AGND	Analog Ground
ANALOG INPUTS	A6	A6 +ve single (D3 +ve differential)
	A5	A5 +ve single (D2 -ve differential)
	AGND	Analog Ground
	A4	A4 +ve single (D2 +ve differential)
	A3	A3 +ve single (D1 -ve differential)
ANALOG INPUTS	AGND	Analog Ground
	A2	A2 +ve single (D1 +ve differential)
	A1	A1 +ve single (D0 -ve differential)
	AGND	Analog Ground
	A0	A0 +ve single (D0 +ve differential)

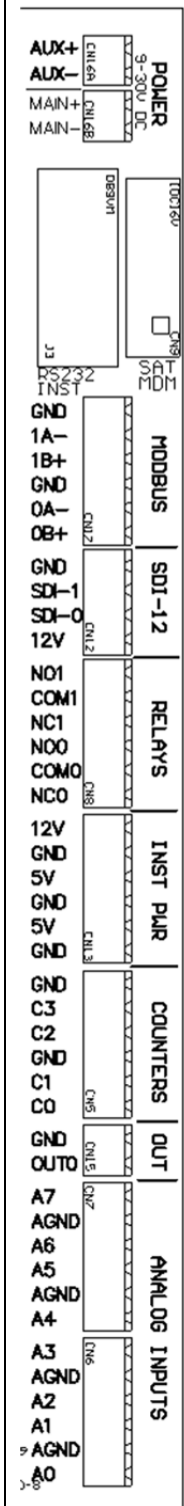



5.3 3004 Neon Remote Logger – Connections/Terminations

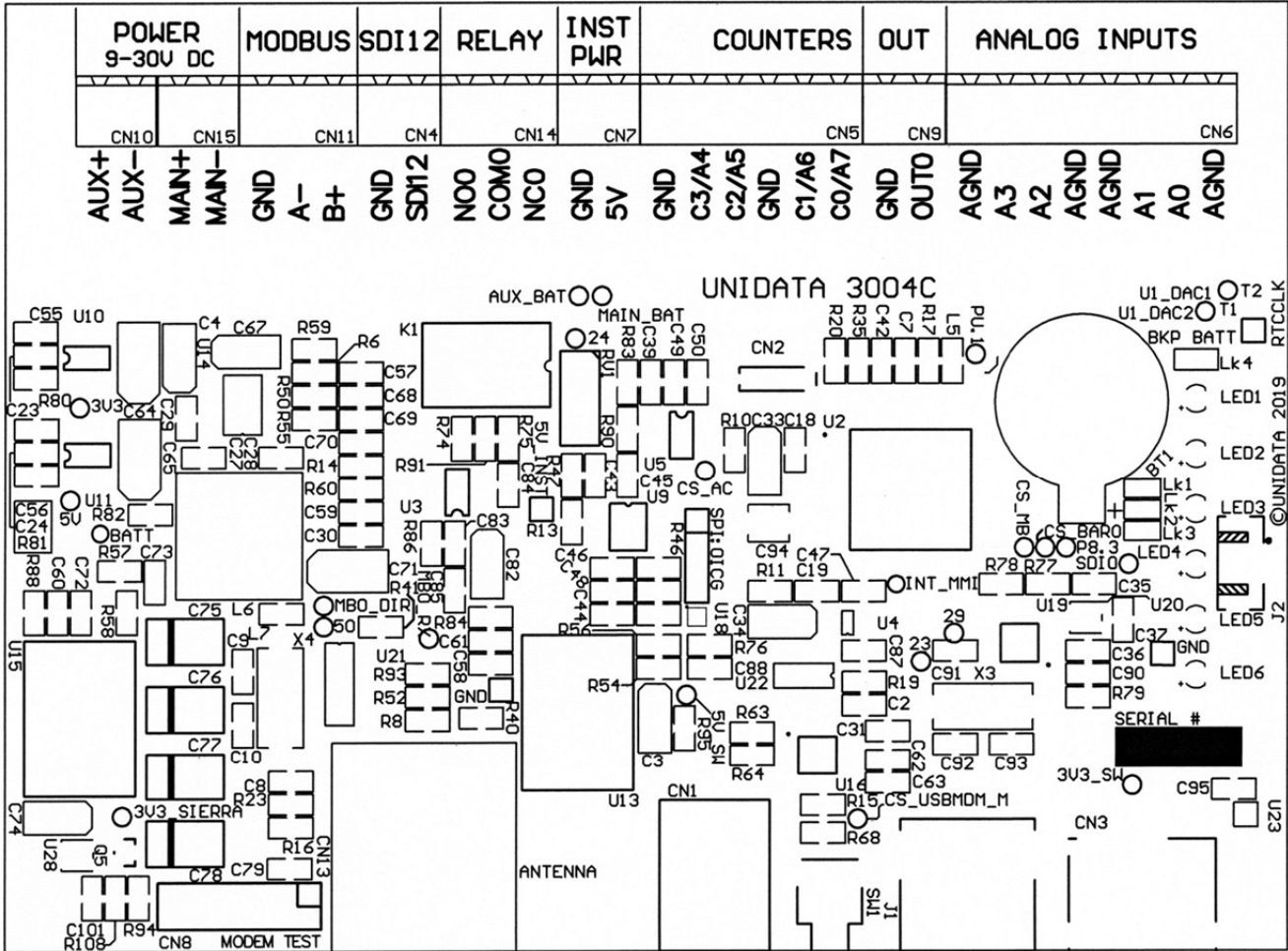

		Terminal	Connection	Description
AUX+	CN10	POWER 9-30VDC	AUX+	External 9V to 30VDC Power Supply +
AUX-			AUX-	External 9V to 30VDC Power Supply -
MAIN+	CN15	POWER 9-30VDC	MAIN+	External 9V to 30VDC Power Supply +
MAIN-			MAIN-	External 9V to 30VDC Power Supply -
GND	CN11	MODBUS	GND	Ground MODBUS
A-			A-	MODBUS A-
B+			B+	MODBUS B+
GND	CN4	SDI-12	GND	Ground SDI-12
SDI12			SDI-1	SDI-12 Signal
NO0	CN14	RELAY	NO0	Normally open 0 1A 30Vdc, 0.5A 125VAC
COM0			COM0	Common 0
NC0			NC0	Normally closed 0 1A 30Vdc, 0.5A 125VAC
GND	CN7	INSTRUMENT POWER	5V	5V regulated 100mA fused
5V			GND	Ground
GND	CN5	COUNTERS / ANALOG INPUTS	GND	Ground
C3/A4			C3/A4	16 bit, DC to 32Hz potential free contacts or 0 to 5VDC
C2/A5			C2/A5	16 bit, DC to 32Hz potential free contacts or 0 to 5VDC
GND			GND	Ground
C1/A6			C1/A6	16 bit, DC to 32Hz potential free contacts or 0 to 5VDC
C0/A7			C0/A7	16 bit, DC to 320Hz potential free contacts or 0 to 5VDC
GND	CN9	OUT	GND	Ground
OUT0			OUT0	Digital Output0 Open Drain FET 30V DC, 250mA max
AGND	CN6	ANALOG INPUTS	AGND	Analog Ground
A3			A3	A3 +ve single
A2			A2	A2 +ve single
AGND			AGND	Analog Ground
AGND			AGND	Analog Ground
A1			A1	A1 +ve single
A0			A0	A0 +ve single
AGND			AGND	Analog Ground

5.4 3004-M000 – Connections/Terminations

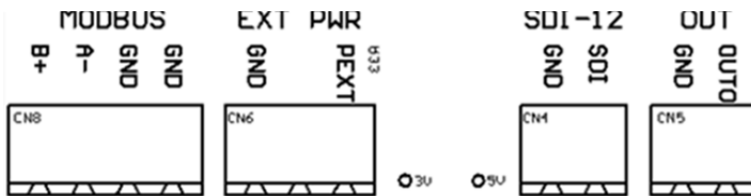
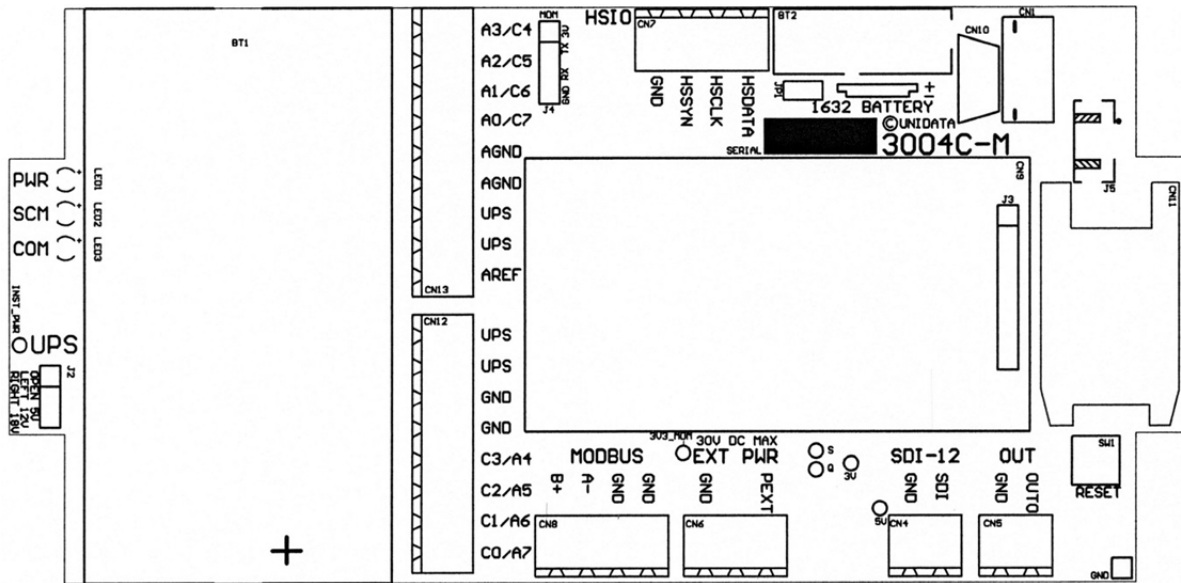

Terminal	Connection	Description
OUT	OUT0	Digital Output0 Open Drain FET 30V DC., 250mA max
	GND	Ground
SDI-12	SDI-1	SDI-12 Signal
	GND	Ground
EXT PWR	GND	External Power Supply -
	PEXT	External Power Supply + (9V to 30V)
MODBUS	B+	MODBUS Channel 1 B+
	A-	MODBUS Channel 1 A-
	GND	Ground MODBUS

Terminal	Connection	Description
HSIO	HSDATA	HSIO Data
	HSCLK	HSIO Clock
	HSSYN	HSIO Sync
	GND	HSIO Ground

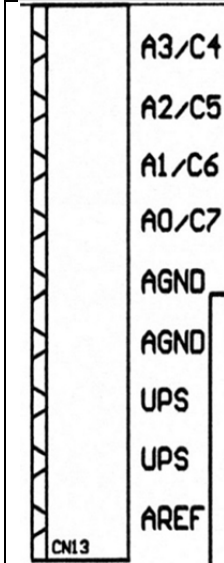
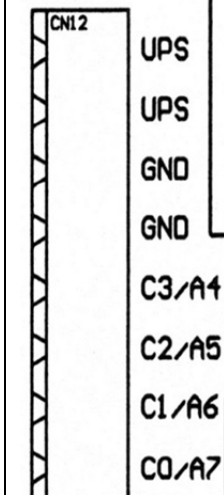

Terminal	Connection	Description
 <p>CN13</p> <p>A3/C4</p> <p>A2/C5</p> <p>A1/C6</p> <p>A0/C7</p> <p>AGND</p> <p>AGND</p> <p>UPS</p> <p>UPS</p> <p>AREF</p>	A3/C4	Analog A3 +ve single (or Optional Counter C4)
	A2/C5	Analog A2 +ve single (or Optional Counter C5)
	A1/C6	Analog A1 +ve single (or Optional Counter C6)
	A0/C7	Analog A0 +ve single (or Optional Counter C7)
	AGND	Analog Ground
	AGND	Analog Ground
	UPS	Instrument Power 5V or 12V or 18V Regulated 80mA
	UPS	Instrument Power 5V or 12V or 18V Regulated 80mA
	AREF	Instrument Reference Voltage 5V 10mA Max
	 <p>CN12</p> <p>UPS</p> <p>UPS</p> <p>GND</p> <p>GND</p> <p>C3/A4</p> <p>C2/A5</p> <p>C1/A6</p> <p>C0/A7</p>	UPS
UPS		Instrument Power 5V or 12V or 18V Regulated 80mA
GND		Ground
GND		Ground
C3/A4		16 bit, DC to 300Hz potential free contacts or 0 to 5VDC or Optional Analog A4
C2/A5		16 bit, DC to 3kHz potential free contacts or 0 to 5VDC or Optional Analog A5
C1/A6		16 bit, DC to 300Hz potential free contacts or 0 to 5VDC or Optional Analog A6
C0/A7		16 bit, DC to 3kHz potential free contacts or 0 to 5VDC or Optional Analog A7

## 5.5 3001-M0 Neon Remote Nano Logger – Connections/Terminations

### 5.5.1 Option 1 SDI-12 INSITU Sensor

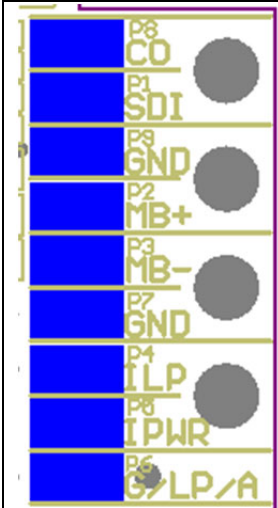
	JP Config	Connection	Description	Cable Colour
	JP1 – CLOSED (if needed, to supply power to sensor)  JP2 – OPEN  JP3 RIGHT (linking pins 1&2 to ground black wire)  JP4 - OPEN		P8 C0	N/A
		<b>P1 SDI</b>	<b>SDI-12 Signal</b>	<b>White</b>
		P9 GND	N/A	N/A
		<b>P2 MB+</b>	<b>Ground</b>	<b>Blue</b>
		<b>P3 MB-</b>	<b>Ground</b>	<b>Green</b>
		<b>P7 GND</b>	<b>Insitu housing GND</b>	<b>TBA</b>
		P4 ILP	N/A	N/A
		<b>P5 IPWR</b>	<b>External Power</b>	<b>Red</b>
		<b>P6 G/LP/A</b>	<b>Ground</b>	<b>Black</b>

### 5.5.2 Option 2 Modbus INSITU Sensor

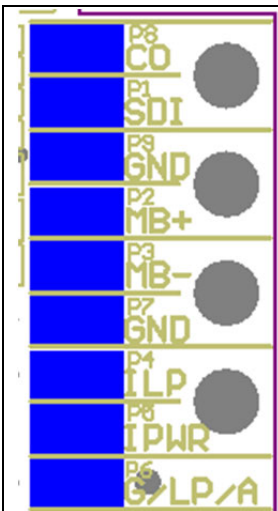
	JP Config	Connection	Description	Cable Colour
	JP1 – CLOSED (if needed, to supply power to sensor)  JP2 – OPEN  JP3 RIGHT (linking pins 1&2 to ground black wire)  JP4 - OPEN		P8 C0	N/A
		P1 SDI	N/A	N/A
		P9 GND	N/A	N/A
		<b>P2 MB+</b>	<b>RS485+</b>	<b>Blue</b>
		<b>P3 MB-</b>	<b>RS485-</b>	<b>Green</b>
		<b>P7 GND</b>	<b>Insitu housing GND</b>	<b>TBA</b>
		P4 ILP	N/A	N/A
		<b>P5 IPWR</b>	<b>External Power</b>	<b>Red</b>
		<b>P6 G/LP/A</b>	<b>Ground</b>	<b>Black</b>

### 5.5.3 Option 3 4-20mA INSITU Current Loop Sensor

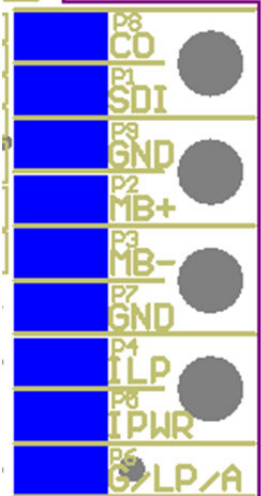
	JP Config	Connection	Description	Cable Colour
	<p>JP1 – OPEN</p> <p>JP2 RIGHT (linking pins 1&amp;2 to supply loop power to sensor)</p> <p>JP3 LEFT (linking pins 2&amp;3 to feed return current in to analog input)</p> <p>JP4 - CLOSED (to feed return current through loop current sensing resistor)</p>		P8 C0	N/A
		P1 SDI	N/A	N/A
		P9 GND	N/A	N/A
		P2 MB+	N/A	N/A
		P3 MB-	N/A	N/A
		<b>P7 GND</b>	<b>Insitu housing GND</b>	<b>TBA</b>
		<b>P4 ILP</b>	<b>Loop Supply Output</b>	<b>Brown</b>
		P5 IPWR	N/A	N/A
		<b>P6 G/LP/A</b>	<b>Loop Supply Return</b>	<b>Black</b>

### 5.5.4 Option 4 SQL Modbus Sensor

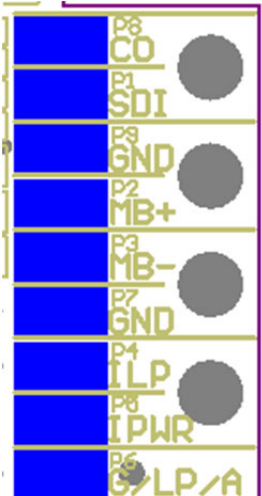
	JP Config	SQL Pin No.	Description	Cable Colour
	<p>JP1 – CLOSED (if needed, to supply power to sensor)</p> <p>JP2 – OPEN</p> <p>JP3 RIGHT (linking pins 1&amp;2 to ground black wire)</p> <p>JP4 - OPEN</p>			N/A
			N/A	N/A
			N/A	N/A
		<b>2</b>	<b>RS485+</b>	<b>Blue</b>
		<b>3</b>	<b>RS485-</b>	<b>Green</b>
			N/A	N/A
			N/A	N/A
		<b>5</b>	<b>Sensor Power (optional)</b>	<b>Red</b>
		<b>7</b>	<b>Ground</b>	<b>Grey</b>

### 5.5.5 Option 5 SQL SDI-12 Sensor

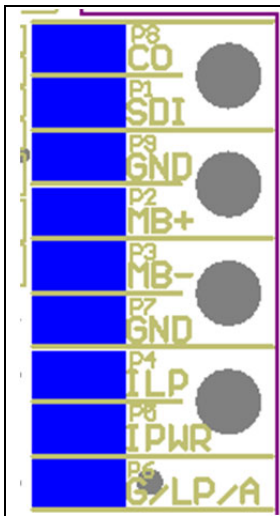
	JP Config	Connection	Description	Cable Colour
	<p>JP1 – CLOSED (if needed, to supply power to sensor)</p> <p>JP2 – OPEN</p> <p>JP3 RIGHT (linking pins 1&amp;2 to ground black wire)</p> <p>JP4 - OPEN</p>			N/A
1		SDI-12 Signal	White	
			N/A	N/A
			N/A	N/A
			N/A	N/A
			N/A	N/A
5		Sensor Power (optional)	Red	
7		Ground	Black	

### 5.5.6 Option 6 SQL Voltage Sensor

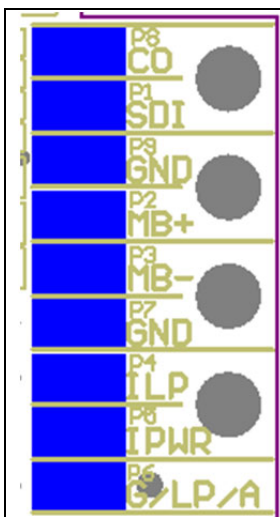
	JP Config	Connection	Description	Cable Colour
	<p>JP1 – CLOSED (as needed, to supply power to sensor)</p> <p>JP2 LEFT (linking pins 2&amp;3 )</p> <p>JP3 RIGHT (linking pins 1&amp;2 to ground black wire)</p> <p>JP4 - OPEN</p>		N/A	N/A
		N/A	N/A	N/A
		N/A	N/A	N/A
		N/A	N/A	N/A
		N/A	N/A	N/A
		N/A	N/A	N/A
4		Analog Input	Brown	
5		Sensor Power (optional)	Red	
7	Ground	Black		

### 5.5.7 Option 7 SQL 3 wire 4-20mA sensor

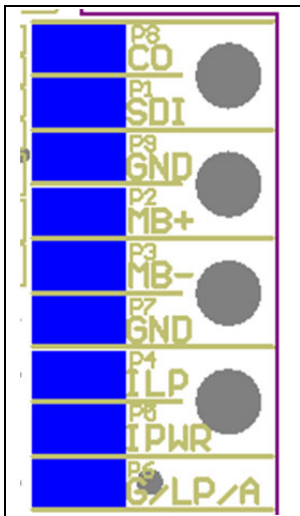
	JP Config	Connection	Description	Cable Colour
	JP1 – CLOSED (as needed, to supply power to sensor)	N/A	N/A	N/A
		N/A	N/A	N/A
		N/A	N/A	N/A
	JP2 LEFT (linking pins 2&3 )	N/A	N/A	N/A
	JP3 RIGHT (linking pins 1&2 to ground black wire)	N/A	N/A	N/A
		N/A	N/A	N/A
	JP4 - CLOSED (to feed return current through loop current sensing resistor)	4	4-20mA Input	Brown
		5	Sensor Power (optional)	Red
		7	Ground	Black

### 5.5.8 Option 8 SQL 2 wire 4-20mA sensor

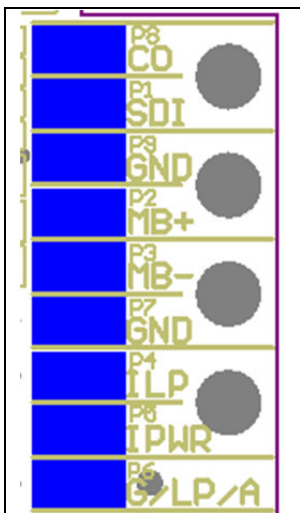
	JP Config	Connection	Description	Cable Colour
	JP1 – CLOSED (as needed, to supply power to sensor)	N/A	N/A	N/A
		N/A	N/A	N/A
		N/A	N/A	N/A
	JP2 LEFT (linking pins 2&3 )	N/A	N/A	N/A
	JP3 RIGHT (linking pins 1&2 to ground black wire)	N/A	N/A	N/A
		N/A	N/A	N/A
	JP4 - CLOSED (to feed return current through loop current sensing resistor)	4	Loop Return	Brown
		5	Loop Send	Red
		7	Case Ground/Shield	Black
	JP5 – CLOSED			

### 5.5.9 Option 9 SQL Counter Input

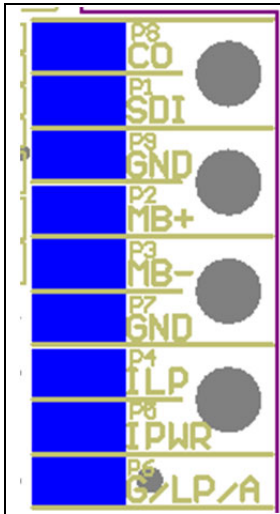
	JP Config	Connection	Description	Cable Colour
	JP1 – CLOSED (if needed, to supply power to sensor)	6	Counter Input	Purple
		N/A	N/A	N/A
		N/A	N/A	N/A
		N/A	N/A	N/A
	JP2 – OPEN	N/A	N/A	N/A
	JP3 RIGHT (linking pins 1&2 to ground black wire)	N/A	N/A	N/A
		N/A	N/A	N/A
	JP4 - OPEN	N/A	N/A	N/A
5	Sensor Power (optional)	Red		
7	Ground	Black		

### 5.5.10 Configuring Input Signal Jumpers

These will normally be factory set upon ordering, but may be changed by the user to accommodate a different input sensor type. Correct static electricity handling precautions should be observed when handling the circuit board assembly to alter the jumpers

Option	Probe Type	JP1	JP2	JP3	JP4	JP5
1	SDI-12 Insitu	As needed	Open	Right	Open	Open 15V, Closed 18V Power
2	Modbus Insitu	As needed	Open	Right	Open	Open 15V, Closed 18V Power
3	4-20mA Insitu	Open	Right	Left	Closed	Open 15V, Closed 18V Loop Power
4	SQL Modbus	As needed	Open	Right	Open	Open 15V, Closed 18V Power
5	SQL SDI-12	As needed	Open	Right	Open	Open 15V, Closed 18V Power
6	SQL Voltage	As needed	Left	Right	Open	Open 15V, Closed 18V Power
7	SQL 3 wire 4-20mA	As needed	Left	Right	Closed	Open 15V, Closed 18V Sensor Power
8	SQL 2 wire 4-20mA	Closed	Left	Right	Closed	Closed 18V Loop Power
9	SQL Counter Input	As needed	Open	Right	Open	Open 15V, Closed 18V Power

JP1 Open for self-powered sensor, Closed if NRL will power the sensor via scheme switched power

JP2 Left Set P4 function to A0 in, Right Set P4 function to Loop Power out

JP3 Left Set P6 function to A0 in, Right Set P6 function to GND

JP4 Close for 120R loop resistor in circuit on A0

JP5 Open 15V, Closed 18V Instrument Power Output

### 5.5.11 SQL Signal 7 Pin Input Connector Pinout

Pin No.	Wire Colour	Pad No.	Signal Name
1	White	P1	Sdi-12
2	Blue	P2	RS485 +
3	Green	P3	RS485-
4	Brown	P4	A0 or 4-20mA Loop Send
5	Red	P5	Sensor Power (Out)
6	Purple	P8	C0
7	Black	P6	GND or 4-20mA Loop Return

### 5.5.12 Insitu Signal 6 Pin Input Connector Pinout

Wire Colour	Pad No.	Signal Name
White	P1	SDI-12
Blue	P2	RS 485+
Green	P3	RS 485-
Brown	P4	4-20mA Loop Send
Red	P5	Sensor Power (Out)
Black	P6	GND or 4-20mA Loop Return
GND Lug	P7	GND

### 5.5.13 M12 Power 4 Pin Input (Male) Connector Pinout

Pin No.	Wire Colour	Pad No.	Signal Name
1	Brown	P1	EXT 12V DC
2	White	P2	GND
3	Blue	P3	Lithium 3.6V
4	Black	P4	GND

### 5.5.14 M12 Power 4 Pin Output (Female) Connector Pinout

Pin No.	Wire Colour	Signal Name
3	Red	Power Out
4	Black	GND

### 5.5.15 Lithium Battery Pack Jumper Cable

Cable length is 20cm, 2 core battery cable, 4 pin Plug and socket connections

Pin No.	Wire Colour	Signal Name
3	Red	Power Out
4	Black	GND









### 5.5.16 External Power Cable

Cable is 1m length, 2 core battery cable, 4 Pin socket connector

Pin No.	Wire Colour	Signal Name
1	Red	External Power In
2	Black	GND

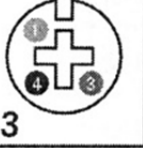
**More to know:**

No. of Poles & Contact Configuration (Connection side view)

Male				Male	
Female				Female	

Color Identification:

1 = Brown, 2 = White, 3 = Blue, 4 = Black, 5 = Green

Color Identification:

1 = White, 2 = Brown, 3 = Green, 4 = Yellow, 5 = Gray, 6 = Pink, 7 = Blue, 8 = Red



## 6.0 APPENDIX INSERTING SIM CARD AND SD CARD

Different SIM Card Sizes

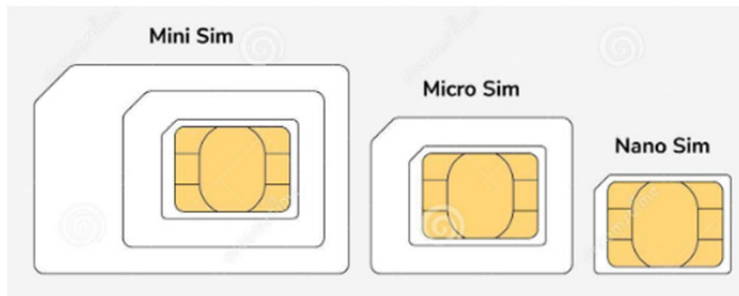
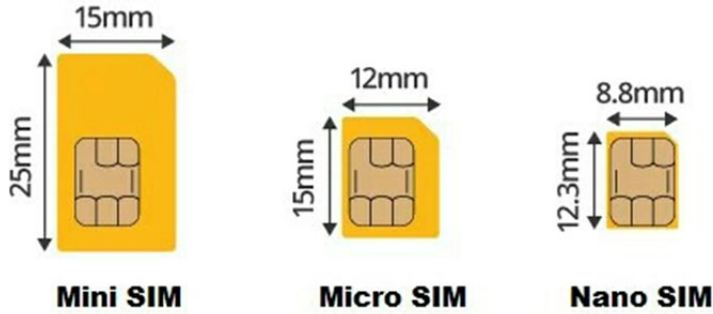

Different SD Card Sizes



SD or Full SD - 32 x 24mm in size, 2.1mm thick

miniSD - 20 x 21.5 mm in size, 1.4mm thick.

microSD - 15 x 11 mm, 1mm thick.

### 6.1 NRL 3001

Caution – The circuit board of the 3001 NRL logger contains static sensitive components. Precautions should be taken against electrostatic discharge before opening the 3001 NRL enclosure and inserting or removing the SIM card or SD card

- Use 8GB or 16GB microSD Card - Formatted to FAT32
- Use micro SIM

NRL 3001 comes with uSIM + uSD Combo Socket so both, SIM Card and SD Card, are utilising same connector.

- Insert the micro Sim Card in the “bottom” pocket, one closer to the PCB:

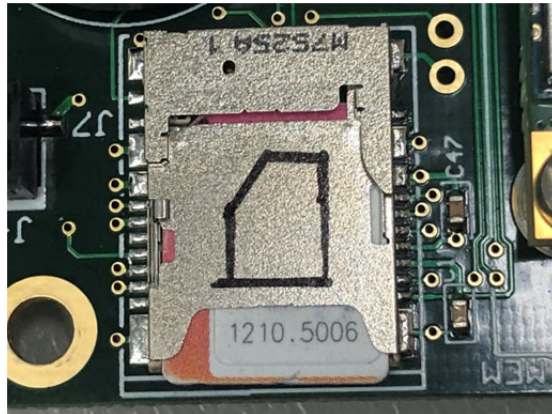

If PCB is already assembled on to the lid of the enclosure, SIM/SD Card connector position is shown below:





- SIM connector is NOT spring/push type of connector so in order to take SIM Card out tool, like tweezers, needs To be used in order to eject puller (small clip). Using tweezers, gently slide puller towards yourself.

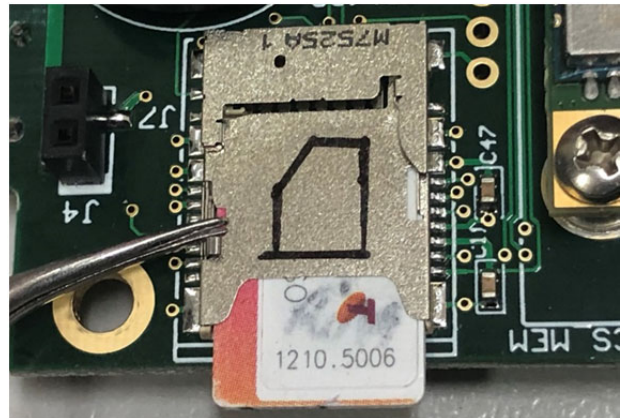
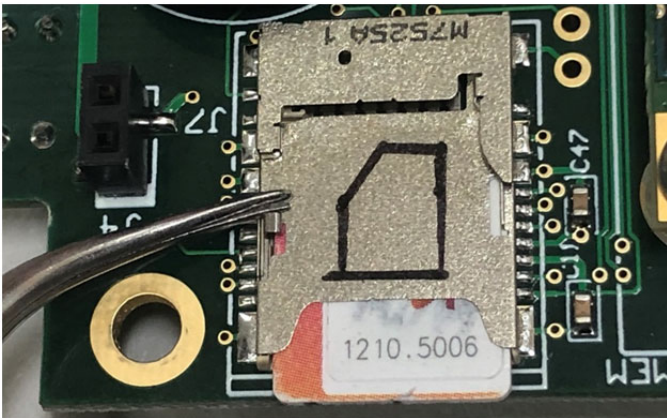
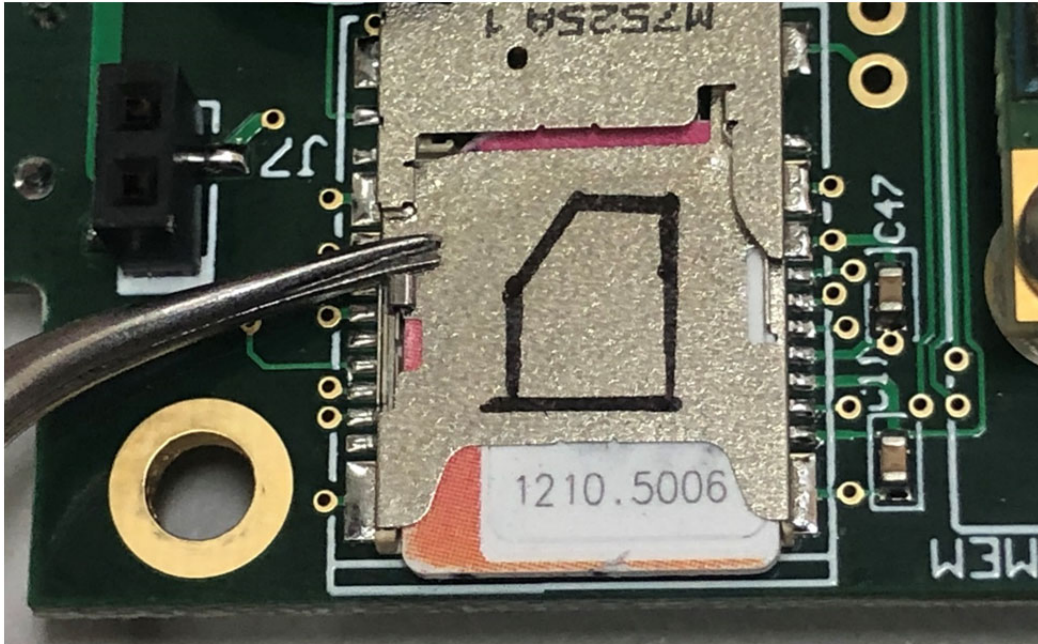

- Insert micro SD Card into the top pocket of the connector:





SD card installed:

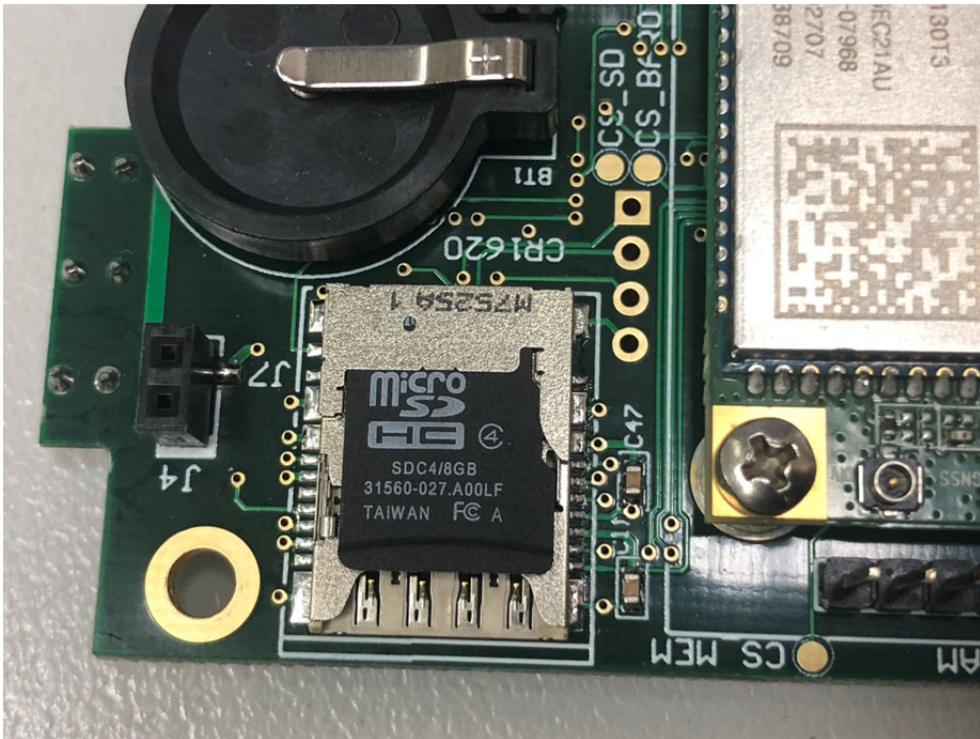

SD Card connector is NOT spring/push type of connector so in order to take SD Card out, tool, like back of the tweezers, needs to be used in order to gently slide SD Card out.

