



Multi-Parameter

Smart Sensor and Datalogger



Introduction4
 What is the Multi-Parameter Smart Sensor?.....4
 Features4
 Initial Inspection and Handling4
 Do’s and Don’ts.....5
Installation and Operation5
 Connecting to External Power and a Computer5
Installing the Aqua4Plus Software.....5
Calibration6
Field Deployment.....6
Real-time Data.....7
Data Logging8
Reports9
Storing Sensor 12
Appendix A: Technical Specifications 12
Wiring Information..... 12
 Dimensions and Specifications..... 13
Appendix B: Reading the Multi-Parameter via Direct Read..... 15
Limited Warranty/Disclaimer..... 16

About this Manual

This manual covers basic use of the Multi-Parameter Smart Sensor. Further details about each connected probe, including calibration information, can be found in their respective manuals. Be sure to refer to these manuals for important information on care and maintenance of your probe. Detailed software information can be found in the *Aqua4Plus Software Manual*. Information on using these with other Modbus equipment, such as panel meters or RTU/PLC applications, refer to the application note available on our website at www.seametrics.com.

What is the Multi-Parameter Smart Sensor?

The Seametrics Multi-Parameter Smart Sensor combines up to three Seametrics Smart Sensor probes in a single, easy-to-deploy, unit. Depending on configuration the Multi-Parameter Sensor can measure pH, ORP, temperature, conductivity, salinity, TDS, pressure, level, and dissolved oxygen or turbidity, depending on configuration.

The Multi-Parameter Smart Sensor is powered from a 12 VDC power supply and can be networked with other Seametrics Smart Sensors, either directly from a single computer or via a third party System.

Features

- Measures pH, ORP, temperature, conductivity, salinity, TDS, pressure level, and dissolved oxygen or turbidity (depending on configuration)
- Modbus® and SDI-12 interface for greater flexibility
- Non-volatile memory
- RS485 network — connect with other Seametrics Smart Sensors
- Modular design — accommodate changes to parameter and data needs
- Flexible, Windows®-based programming
- Real time viewing
- Easy export to spreadsheets and databases
- Direct read option — use with panel meters or RTU/PLC applications
- Fits in 2" (5.1 cm) well

Initial Inspection and Handling

Upon receipt of your smart sensor, inspect the shipping package for damage. After opening the carton, look for concealed damage, such as a cut cable. If damage is found, immediately file a claim with the carrier. Check the label attached to the cable at the connector end for the proper cable length.

Do's and Don'ts

Do handle the device with care.

Don't install the device so that the connector end is submerged.

Don't support the device with the connector or with the connectors of an extension cable. Use a strain relief device to take the tension off the connectors.

Don't allow the device to free-fall down a well as impact damage can occur.

Don't bang or drop the device on hard objects.

Connecting to External Power and a Computer

The Multi-Parameter sensor normally comes with Seametrics' 12VDC power supply. Simply connect the sensor cable to the female connector on the power box. (Note: the individual probe units do not have internal batteries.)

Connect the Seametrics USB communication cable to the male connector on the power box. (For alternate connection options, see Appendix B.)

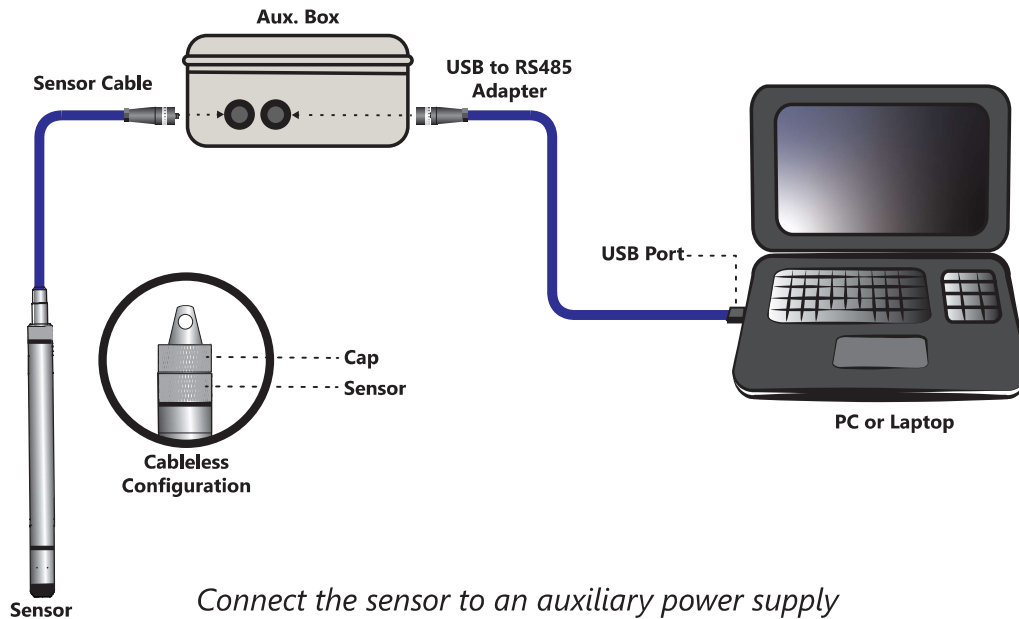

Installing the Aqua4Plus Software

The Multi-Parameter Sensor comes with the Aqua4Plus host software to be installed on your PC or laptop. Use this software to calibrate the sensor, to program the datalogger, to retrieve data from the logger, to view collected data, and to export data to external files for use with spreadsheets or databases. Refer to the Aqua4Plus software manual for details on installing and using Aqua4Plus.

NOTE: When using Aqua4Plus (or any other Modbus software), each probe will appear on a separate Modbus address—two to three addresses, depending on configuration.

Calibration

All active channels can be calibrated in the field. Temperature and Pressure channels rarely need calibrating, however the pH, ORP, and Conductivity channels should be calibrated before first use and periodically thereafter. Refer to the specific probe manuals for details.

Environmental conditions of turbulence and temperature swings, as well as local likelihood for bio-fouling or mineral deposition, can vary considerably from site to site. Therefore, where the sensor is to be used for long-term monitoring, it is recommended that the calibration be initially checked frequently until a performance history is established.

Field Deployment

The black reference reservoir at the lower end of the TempHion™ Smart Sensor is shipped filled with Seametrics reference solution. (If your reference reservoir is not filled, see the Maintenance section of the TempHion manual.) The black reference assembly has two grooves. The upper groove contains a small hole that forms the liquid junction port. During shipping and storage, an o-ring is located in the upper groove, preventing reference solution leakage and contamination. Be sure to move the o-ring to the lower groove before deploying, thus exposing the liquid junction port. If the o-ring continues to cover the opening, readings will not be representative or accurate.



Be sure to move the o-ring to the lower groove before deploying, thus exposing the liquid junction port.

Lower the sensor to the desired depth. Fasten the cable to the well head using the strain-relief system. (Note that for shallow installations the liquid in which the sensor is submerged must, at all times, reach high enough to cover all sensing elements.)

Do not install such that the connector at the top of the connector might become submerged with changing weather conditions. The box and connectors can withstand incidental splashing but is are not designed to be submerged.

Real-time Data

Connect to sensor and select the Real-time data tab

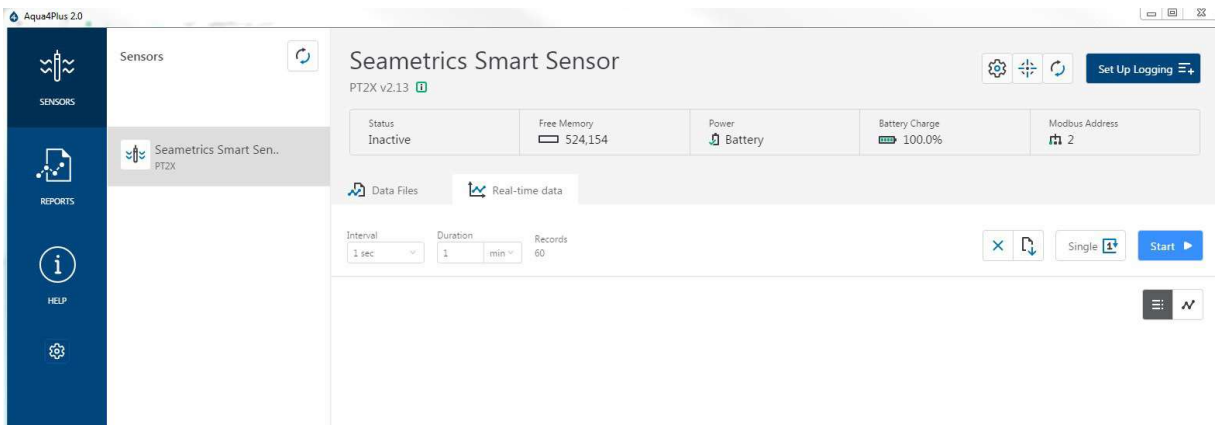

To start real-time readings click Start, readings default to table view. To switch to Real-time graphing view click the graph icon 

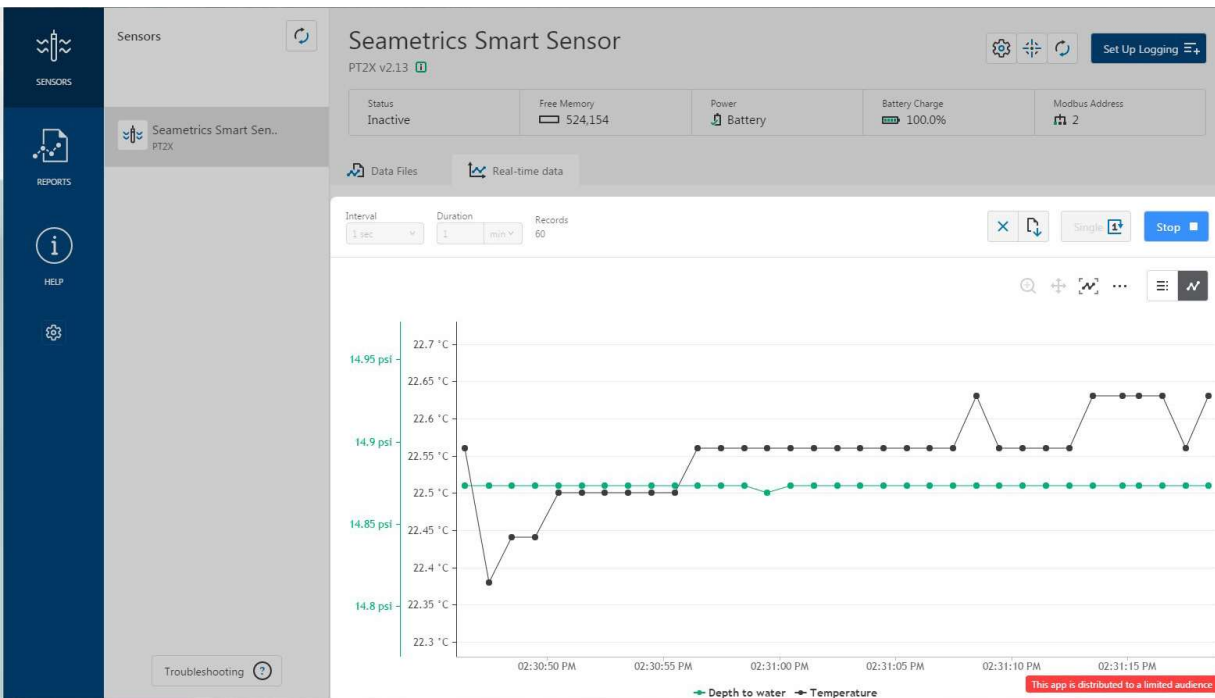

Real-time readings default to a 1 second interval for 1 minute, to adjust enter your desired settings here:

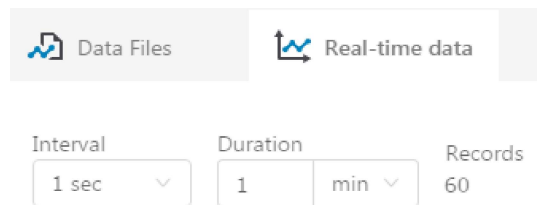

To save this data to the Reports section click the  button located next to the Single button in the Real-Time tab. This will permanently save this real-time data set to your Reports database.

Data Logging

Select Set Up Logging from the sensor screen. If there are no files currently on the sensor you'll see the Set Up Logging button active under the Data Files tab as well as in the upper menu. Once files have been started/logged on the sensor they will be displayed under the Data Files tab.

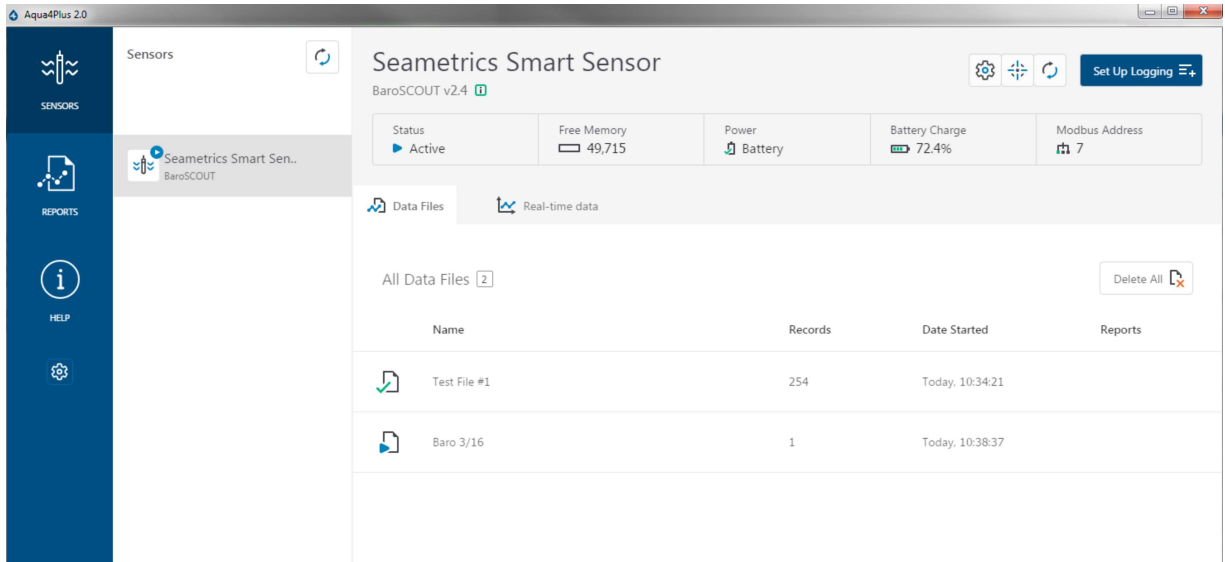

Set Up Logging Window

Here you will name your data file and set up the recording interval and duration of each logging phase. Select your desired recording interval and duration for each phase, Aqua4Plus 2.0 will display the available memory at the bottom of the window.

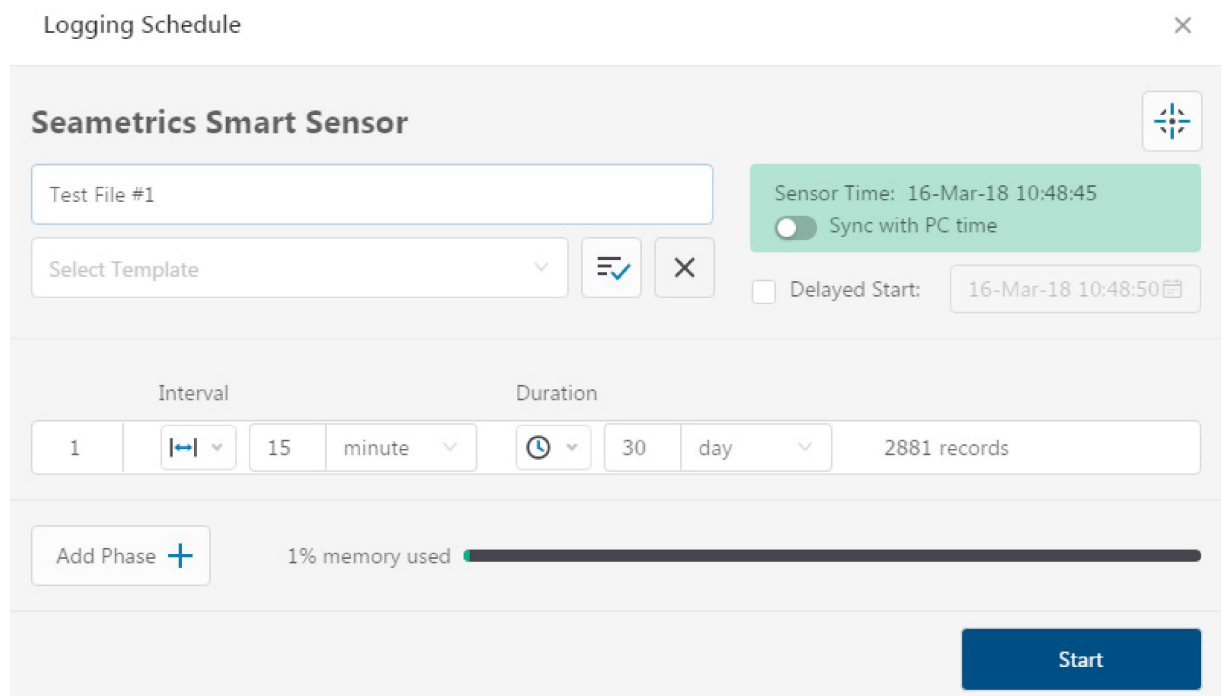

Reports

Data downloaded from your sensor is stored in the Reports section of Aqua4Plus 2.0 for viewing and editing. The files will be saved to default data folder on your PC as well. See Program Settings for default data folder location.

All Reports		↓	🔍	Delete All
Group by	Date	Size	Name	
Name	Date Modified	Records	Source	Created By
March, 2018				
Baro 3/16 Today, 10:38:37 - Today, 10:53:37	Today, 10:57:39	2	Downloaded	seanv
Baro 3-12 12-Mar 13:52:32 - Today, 10:14:32	Today, 10:15:32	5,543	Downloaded	seanv
Desk 3-12 12-Mar 14:02:55 - 13-Mar 15:10:55	13-Mar 15:20:14	1,509	Compensated	seanv
Desk 3-12 12-Mar 14:02:55 - 13-Mar 15:10:55	13-Mar 15:11:39	1,509	Downloaded	seanv
Desk CT2X 3-12 12-Mar 13:55:53 - 12-Mar 13:59:53	13-Mar 15:11:03	5	Downloaded	seanv
February, 2018				
300k test 21-Feb 15:30:09 - 22-Feb 07:40:51	22-Feb 12:02:29	232,971	Downloaded	seanv
Test File #2 21-Feb 15:19:36 - 21-Feb 15:22:55	21-Feb 15:30:43	400	Downloaded	seanv
Test File #1 21-Feb 14:21:48 - 21-Feb 14:22:37	21-Feb 15:20:04	100	Downloaded	seanv

In the main view you'll see a list of reports sorted by date, size, or file name as selected here:



You can also search reports by keyword using the search box

Click on a report to bring up the report details.

Reports are displayed in graphing view by default. You can zoom to specific sections by selecting a section with you mouse or by adjusting the slider below the graph.



You may change the display units within the graph view by selecting the appropriate channel here:

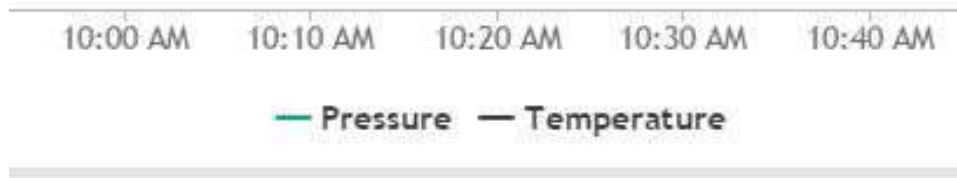

Click  to switch to full screen graphing view

Graph saving and export options are available here:



Click  to view data as a table

Click  to view data statistics

Report Details

Desk 3-12

Status	Records	Date Started
Incomplete	1,509	🕒 12-Mar-18 14:02:55

 Information
  Data
  Schedule

Name	Temperature °C	Conductivity µS/cm	Pressure psi	Salinity PSU	TDS mg/L
Sensor Range	150K ohm	0-300 mS/cm	500 psia	unknown	unknown
Min	21.02	337.8	14.535	0.1626	165.5
Max	23.45	360.0	14.700	0.1725	176.4
Mean	22.51	346.4	14.632	0.1664	169.7
Variance	0.54	38.4	0.002	0.0000	9.2
Deviation	0.74	6.2	0.045	0.0028	3.0
Calibration Date	unknown	19-Feb-18 12:48:12	21-Feb-18 14:22:57	unknown	unknown

The Information tab is a new feature allowing users to add metadata to their reports such as site location, field notes, or comments. The Schedule tab will display the logging setup details for the report.

Report Details

Desk 3-12

Status Incomplete	Records 1,509	Date Started 🕒 12-Mar-18 14:02:55
----------------------	------------------	--------------------------------------

Information | Data | Schedule

Report Name:

Location(GPS or Job Site):

Comment:

Sensor name: Seametrics Smart Sensor

Sensor type: CT2X

Serial number: 0021746043

Last modified: 🕒 13-Mar-18 15:11:39

Downloaded: 🕒 13-Mar-18 15:11:39

Click Export to export the report as a .csv file or .a4d file for distribution or use in 3rd party software.

Click Delete to delete the report from Aqua4Plus 2.0

You can also import .a4d files from compatible sensors into Aqua4Plus 2.0 by clicking [↓](#) at the top of the Reports screen.

A Word About Units

Readings from the Multi-Parameter Sensor can be displayed in various units. Select the units you want from the Sensor Settings button.

- Temperature: Degrees Celsius, Fahrenheit, or Kelvin
- pH: pH or mV
- Redox (ORP): mVH or mV
- Conductivity: uS/cm, mS/cm
- TDS: mgL
- Salinity: PSU
- Pressure: PSI, Ft H₂O, mH₂O, and many others
- DO: ppm
- Turbidity: NTU

When using pH, ppm, or mVH units, all readings are automatically compensated for temperature and all field calibration factors are applied. When using millivolts or ohms, only the actual millivolt or resistance values are displayed - no adjustments are made.

Storing Sensor

For long-term storage, the TempHion probe should be stored dry.

- Unscrew and empty the reservoir cap. **Do not touch or scratch the sensing elements or the reference electrode!**
- Clean the cap and electrode assembly as detailed in the TempHion manual.
- Let cap and electrode assembly dry thoroughly.
- Replace cap to protect electrode from scratching.

Appendix A: Technical Specifications

Wiring Information

Cable Type: 9-conductor, shielded

Shield	=	Ground
White	=	Vaux (6 to 13 VDC)
Brown	=	SDI-12
Orange	=	Vbat+ (1.8 to 3.3 VDC)
Blue	=	Ground
Yellow	=	Comm D+
Purple	=	Comm D-

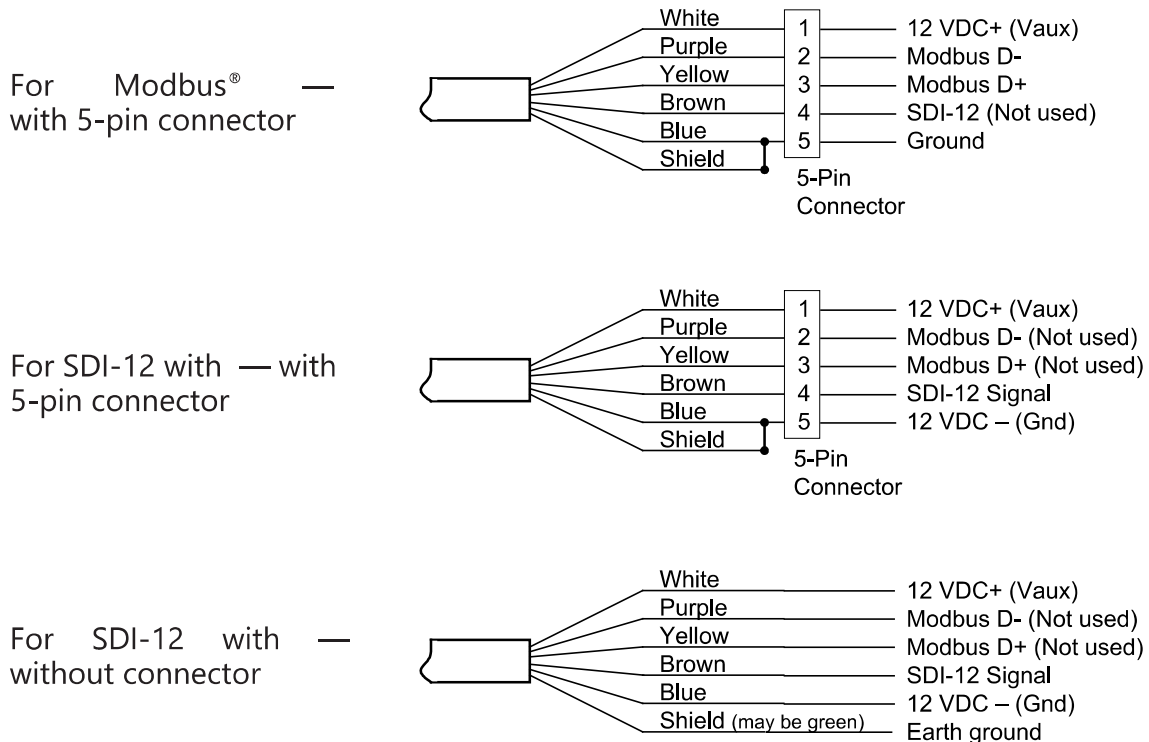

Dimensions and Specifications

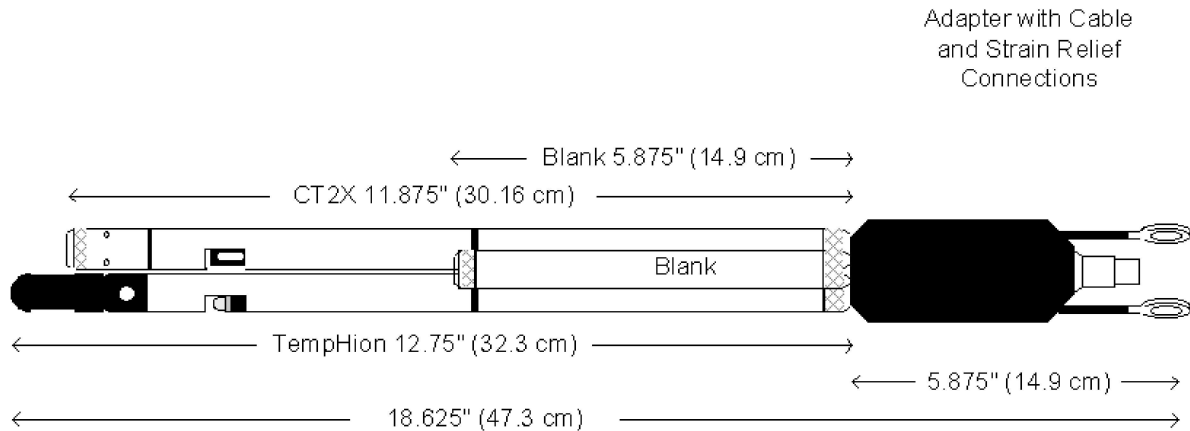

MECHANICAL

Length (with TempHion & CT2X)	18.63" (47.3 cm)
Maximum Diameter	1.75" (4.45 cm)
Weight	2 lb (0.9 kg)
Adapter Material	Acetal
Tube Material	316 stainless steel or titanium
Wire Seal Materials	Flouropolymer and PTFE
Submersible Cable	Polyurethane, polyethylene, FEP or ETFE
Cabel OD	0.28" (0.7 cm)
Cable Weight	4 lbs/100 ft (1.8 kg/30 m)
Maxium Cable Length	2000 feet (610 meter)
Break Strength	138 lbs (62.7 kg)
Maximum Operating Pressure	100 PSI (70 H ₂ O)
Burst Pressure	200 PSI (140 H ₂ O)

GENERAL

Communication	RS485 Modbus® RTU & SDI-12 (ver. 1.3)
Direct Modbus Output	32-bit IEEE floating point
SDI-12 Output	Serial
Internal Math	32-bit floating point
Operating Temperature Range	-5° C to 40° C
Storage Temperature Range	-20° C to 80° C

POWER

External Supply	12 VDC – Nominal 9V-15VDC @ 15mA
------------------------	-------------------------------------

RANGE, RESOLUTION, ACCURACY

	Range	Resolution	Accuracy
Level/Pressure		16 bit	± 0.05% FSO typical ± 0.1% FSO maximum (B.F.S.L. 20° C)
Absolute PSIA	100 PSI		
Absolute mH ₂ O	70 mH ₂ O		
Absolute FtH ₂ O	231 FtH ₂ O		
Conductivity	0-100 mS/cm	0.001 mS/cm	± 0.5% of measured value
Salinity	2-42 PSU	0.001 PSU	± 1% of reading or 0.1 PSU whichever is greater
TDS	4.9-49,000 mg/L	0.1 mg/L	± 0.5% of measured value
pH	1-14 pH units	0.01 pH units	± 0.2 pH units
ORP	± 1200 mV	0.01 mVH	0.1 mVH
Temperature	-5° C to 40° C	0.1° C	± 0.5° C
DO	0-5 ppm	0.01 ppm below 4.0 0.1 above 4.0	1% of reading or 0.02 ppm whichever is greater
Turbidity	0-400 NTU 0-3000 NTU		± 2% or ± 2 NTU @ 25° C whichever is greater

Appendix B: Reading the Multi-Parameter via Direct Read

While the Multi-Parameter sensor comes with Seametrics' easy to use Aqua4Plus software, you can also use standard Modbus® RTU or SDI-12 equipment to easily take readings, so as to tie into your existing equipment or networks. Refer to the specific probe manuals for details.

LIMITED WARRANTY/DISCLAIMER

Seametrics MultiParameter Smart Sensor

A. Seller warrants that products manufactured by Seller when properly installed, used and maintained, shall be free from defects in material and workmanship. Seller's obligation under this warranty shall be limited to replacing or repairing the part or parts or, at Seller's option, the products which prove defective in material or workmanship within TWO (s) years from the date of delivery, provided that Buyer gives Seller prompt notice of any defect or failure and satisfactory proof thereof. Any defective part or parts must be returned to Seller's factory or to an authorized service center for inspection. Buyer will prepay all freight charges to return any products to Seller's factory, or any other repair facility designated by Seller. Seller will deliver replacements for defective products to Buyer (ground freight prepaid) to the destination provided in the original order. Products returned to Seller for which Seller provides replacement under this warranty shall become the property of Seller.

This limited warranty does not apply to lack of performance caused by abrasive materials, corrosion due to aggressive fluids, mishandling or misapplication. Seller's obligations under this warranty shall not apply to any product which (a) is normally consumed in operation, or (b) has a normal life inherently shorter than the warranty period stated herein.

In the event that equipment is altered or repaired by the Buyer without prior written approval by the Seller, all warranties are void. Equipment and accessories not manufactured by the Seller are warranted only to the extent of and by the original manufacturer's warranty.

THE FOREGOING WARRANTIES ARE IN LIEU OF ALL OTHER WARRANTIES, WHETHER ORAL, WRITTEN, EXPRESSED, IMPLIED OR STATUTORY. IMPLIED WARRANTIES OF FITNESS AND MERCHANTABILITY SHALL NOT APPLY. SELLER'S WARRANTY OBLIGATIONS AND BUYER'S REMEDIES THEREUNDER (EXCEPT AS TO TITLE) ARE SOLELY AND EXCLUSIVELY AS STATED HEREIN. IN NO CASE WILL SELLER BE LIABLE FOR CONSEQUENTIAL DAMAGES, LABOR PERFORMED IN CONNECTION WITH REMOVAL AND REPLACEMENT OF THE SENSOR SYSTEM, LOSS OF PRODUCTION OR ANY OTHER LOSS INCURRED BECAUSE OF INTERRUPTION OF SERVICE. A NEW WARRANTY PERIOD SHALL NOT BE ESTABLISHED FOR REPAIRED OR REPLACED MATERIAL, PRODUCTS OR SUPPLIES. SUCH ITEMS SHALL REMAIN UNDER WARRANTY ONLY FOR THE REMAINDER OF THE WARRANTY PERIOD ON THE ORIGINAL MATERIALS, PRODUCTS OR SUPPLIES.

B. With respect to products purchased by consumers in the United States for personal use, the implied warranties including but not limited to the warranties of merchantability and fitness for a particular purpose, are limited to twenty four (24) months from the date of delivery.

Some states do not allow limitations on the duration of an implied warranty, so the above limitation may not apply to you. Similarly, some states do not allow the exclusion or limitation of consequential damages, so the above limitation or exclusion may not apply to you. This limited warranty gives you specific legal rights; however, you may also have other rights which may vary from state to state.

