

aeroqual[®]

DUST SENTRY/PRO AQS

USER GUIDE



Aeroqual Limited
460 Rosebank Road, Avondale
Auckland 1026, New Zealand
t +64 9 623 3013 | f +64 9 623 3012
e technical@aeroqual.com

aeroqual.com

User Guide Revision History

Date	Revision number	Description of change	Affected Sections
June 2017	1	First release	-
September 2017	2	NO2 and VOC added	1, 1.1
May 2018	3	Calibration section updated	5.0
February 2019	4	Combining AQS, Dust Sentry, Dust Sentry Profiler	All
October 2019	5	New internal components and layout, handle	1.0
		Updated specifications	1.6
		Added US power cable	2.5
		New 3 rd party sensor power and data interface	2.7
		Added Sierra modem	4.2
		New "lease mode"	5.0
Updated location of pumps	12.2		
November 2019	6	Direct-read NO ₂ module replaces Ox module.	7
		Calibration steps updated for NO ₂ module.	12.1 12.5
February 2020	7	NO2 and VOC specs	1.5
		Pole mounting options updated	3.1
		Reset Network USB updated	4.4
		VOC flowrates corrected	7
August 2020	8	Surveyor's tripod mounting	3.5

Alternative sources of information and help

In addition to this user guide, Aeroqual offers other sources of information which can assist in the operation of the monitors. The Aeroqual website contains brochures, technical notes, frequently asked questions, and user guides.

<https://www.aeroqual.com/support/resources>

Aeroqual's training website contains a comprehensive document library of technical notes and service and calibration templates to download and print. The training website has detailed descriptions of service activities and calibration and installation examples and is updated regularly. Video tutorials are featured heavily.

www.training.aeroqual.com

For technical support, contact the Aeroqual distributor in your local country. If local technical support is not available contact the Aeroqual support team: technical@aeroqual.com.

Where possible, references to further material will be provided throughout this document

	Online reference	training.aeroqual.com
	Online video	YouTube Channel: Aeroqual Service and Maintenance playlist

Table of Contents

1	Dust Sentry / Dust Sentry Pro / AQS 1 Introduction.....	5
1.1	Overview.....	5
1.2	Product comparison	6
	Applications by product	6
1.3	Optional external sensors.....	7
1.4	Dimensions	7
1.5	Specifications.....	8
2	Quick Setup Guide	9
2.2	Pre-planning.....	11
2.3	Unpacking.....	11
2.4	Assembly	12
2.5	Power Requirements.....	15
2.6	Powering On/Off.....	16
2.7	Connecting auxiliary sensors.....	17
3	Mounting and Site Positioning Guidelines	20
3.1	Mounting.....	20
3.2	Inlet height	21
3.3	Measurement Interference.....	21
3.4	Safety	21
3.5	Surveyor's tripod mounting.....	21
4	Connectivity.....	24
4.1	Aeroqual Connect (via Direct WIFI / LAN).....	24
4.2	Aeroqual Cloud (via Network WIFI / Modem)	25
4.3	Communication settings	30
4.4	Resetting the communication settings back to factory settings	32
5	Operation	33
5.1	Manage Data	33
5.2	Calibration and Service	35
5.3	Configure Instrument.....	35
5.4	Diagnostics and Advanced.....	36
5.5	Administration	37
6	Service & Maintenance.....	40
6.1	Service frequency guidelines.....	40
6.2	Flow meters and flow measurement	41
6.3	Manual Service Mode.....	41
6.4	Journal.....	42
6.5	Maintenance procedures	42
6.6	Factory calibration of Particle Monitor	55
6.7	Scheduled maintenance	56
7	Calibration	57

7.1	Gas module calibration.....	57
7.2	Particle Monitor calibration	67
8	Troubleshooting.....	71
9	Copyright.....	73
10	Compliance.....	73
11	Warranty.....	73
12	Appendix.....	74
12.1	Gas module design	74
12.2	Particulate Matter module design.....	76
12.3	Mains wiring color guide	78
12.5	Calibration Records.....	79

1 Dust Sentry / Dust Sentry Pro / AQS 1 Introduction

1.1 Overview

Dust Sentry / Dust Sentry Pro / AQS 1 (collectively referred to herein as 'monitors') are tools for air quality professionals to target specific applications of interest in industrial, urban environment and regulatory applications. It is a flexible air quality monitoring system that can be configured for a range of uses.

Key technology features of the monitors enable them to deliver data with very strong correlation to EPA-approved monitors – 'Near Reference' – over extended periods of time; several years with appropriate maintenance.

Housed in a rugged, lockable weatherproof (IP 65) enclosure, the monitors include an embedded PC and full software system for remote technical support, data management and analytics.

Users can make use of the embedded PC running proprietary **Aeroqual Connect** instrument operating system, or optional **Aeroqual Cloud** instrument monitoring, management and technical support via secure cloud servers, accessed via web browser (IE, Firefox, Chrome, Safari).

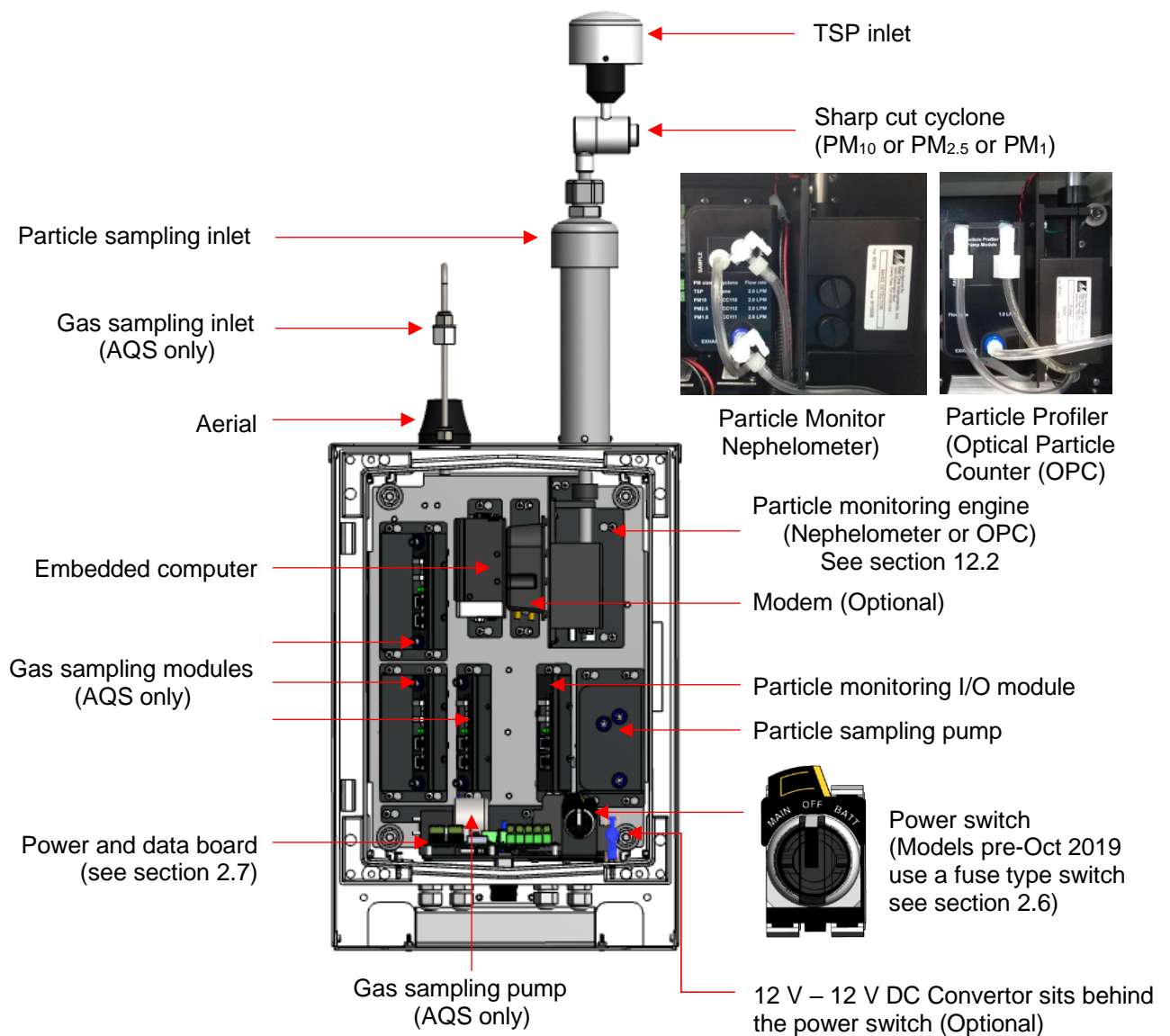

Figure 1-1 Key components – wiring and gas lines not shown

1.2 Product comparison

Dust Sentry and **Dust Sentry Pro** both measure particulate concentrations using laser light scattering but the methodology and optics design are different, this means that the Dust Sentry measures a single size fraction selected by the user but the Dust Sentry Pro measures four size fractions simultaneously.

AQS 1 also measures gases in addition to particulate, up to three gas modules may be integrated.

Product	Particulate Measurement	Gas Measurement
Dust Sentry	TSP <i>or</i> PM ₁₀ <i>or</i> PM _{2.5} <i>or</i> PM ₁	None
Dust Sentry Pro	TSP <i>and</i> PM ₁₀ <i>and</i> PM _{2.5} <i>and</i> PM ₁ <i>and</i> 8 size counts	None
AQS 1	TSP <i>or</i> PM ₁₀ <i>or</i> PM _{2.5} <i>or</i> PM ₁	O ₃ , NO ₂ VOC
	TSP <i>and</i> PM ₁₀ <i>and</i> PM _{2.5} <i>and</i> PM ₁ <i>and</i> 8 size counts	

For specifications see section 1.5.

Applications by product

Applications for Dust Sentry

Designed for those who need to monitor and manage specific outdoor dust and particulate emissions continuously and in real-time.

The Dust Sentry is a nephelometer-based monitor that delivers defensible and accurate mass measurement for PM₁₀, PM_{2.5}, PM₁, or TSP.

The Dust Sentry PM₁₀ is MCERTS certified and SCAQMD 1466 pre-approved.

For more detail see: <https://www.aeroqual.com/product/dust-sentry-pm10-monitor>

Applications for Dust Sentry Pro

Designed for those who need to monitor and manage multiple outdoor dust and particle size fractions simultaneously and in real-time.

The Dust Sentry Pro delivers simultaneous measurement of PM₁₀, PM_{2.5}, PM₁, TSP, and particulate counts for 8 channels; 0.3, 0.5, 0.7, 1.0, 2.0, 3.0, 5.0, 10 microns.

For more detail see: <https://www.aeroqual.com/product/dust-profiler-particle-counter>

Applications for AQS 1

Designed for those who need to monitor and manage specific outdoor dust and particulates, and gases continuously and in real-time.

The AQS 1 delivers affordable and defensible measurement of PM₁₀, or PM_{2.5}, or PM₁, or TSP, and up to three gases, all simultaneously.

For more detail see: <https://www.aeroqual.com/outdoor-air-quality/aqs-mini-air-quality-stations>

1.3 Optional external sensors

The monitors can integrate several external sensors such as weather sensors, solar radiation and noise sensors. These sensors are mounted outside the monitor enclosure. The external sensors below are available factory tested and ready to connect to the monitors.



MetOne MSO weather station



Cirrus MK427 noise meter



Vaisala WXT536 weather station



Gill Instruments Windsonic



Li-Cor LI-200 Pyranometer

See Section 2.7.3.1 for wiring external sensors.

1.4 Dimensions

These dimensions are for a visual representation only, for full details see section 1.5 Specifications.



Dimensions are in millimetres and (Inches) and are the same for DS, AQS1 and DS pro.

1.5 Specifications

Specifications are subject to change, please check www.aeroqual.com for the current specifications.

	Dust Sentry	Dust Sentry Pro	AQS
Particulate Measurement			
Measurement technology	Near forward angle laser scattering nephelometer	Right angle laser scattering particle counter	The AQS 1 can be specified with either a Near forward angle laser scattering nephelometer <u>OR</u> Right angle laser scattering particle counter Particulate measurement specifications will reflect the measurement technology chosen – see panels to the left.
Particle Counts	N/A	Optional Particulate Counts: 0.3, 0.5, 0.7, 1.0, 2.0, 3.0, 5.0, 10 microns (counts range: 0-100,000 counts/L)	
Particle Mass Measurement	Range / ug/m³	Range / ug/m³	
PM1	0 – 60,000	0 - 200	
PM2.5	0 – 60,000	0 - 2000	
PM10	0 – 60,000	0 - 5000	
TSP	0 – 60,000	0 - 5000	
Simultaneous?	No – requires cyclone	Yes	
Accuracy	±(2 µg/m ³ + 5 % of reading)	± (5 µg/m ³ + 15 % of reading)	
Resolution	0.1 µg/m ³	0.1 µg/m ³	
MCERTS certified	PM ₁₀	No	
SCAQMD Rule 1466	Pre-approved	No	
Auto zero check	Yes	No	
Sample flow	2 LPM	1 LPM	
Factory calibration interval	24 months	12 months	
Operating temperature ⁽¹⁾	-10 °C to +50 °C (14 °F to 122 °F)	-10 °C to +45 °C (14 °F to 113 °F)	
Heated inlet	Yes	Yes	
Gas Measurement			(Measurement Resolution)
Ozone	-	-	0 - 500 ppb (0.1 ppb)
Nitrogen Dioxide	-	-	0 - 500 ppb (0.1 ppb)
Volatile Organic Compounds Low	-	-	0 - 500 ppb (0.1 ppb)
Volatile Organic Compounds High	-	-	0 - 30 ppm (0.01 ppm)
Gas calibration interval	-	-	As required
Other			
Connect / Cloud software ⁽²⁾	Yes	Yes	Yes
Power consumption ⁽³⁾	30 W ⁽⁴⁾	30 W ⁽⁵⁾	36.6 W ⁽⁶⁾
Additional sensors	Weather station / Wind Speed and Direction / Noise / Solar incidence		
Dimensions ⁽⁷⁾ H x W x D (Inches)	483 x 330 x 187 mm (19 x 13 x 7.4 “)	483 x 330 x 187 mm (19 x 13 x 7.4 “)	483 x 330 x 187 mm (19 x 13 x 7.4 “)
Weight	<13 kg (28.6 lbs) ⁽⁴⁾	<13 kg (28.6 lbs) ⁽⁴⁾	<14 kg (30.9 lbs) ⁽⁶⁾

⁽¹⁾ Above 40 °C (104 °F) the laser may require more frequent servicing.

⁽²⁾ Software platform: <https://www.aeroqual.com/product/air-monitoring-software>

⁽³⁾ Power consumption based on configuration, excludes 3rd party sensors.

^(4,5) Base specification, nephelometer with heated inlet, modem.

⁽⁶⁾ Base specification, nephelometer with heated inlet, modem, 3 gas modules.

⁽⁷⁾ Dimensions are for enclosure. PM sampling inlet with cyclone adds 360 mm (14.17”) to total height.

2 Quick Setup Guide

2.1.1 Before the monitor arrives (for full pre-planning details see section 2.2)



1. Visit the site and assess monitor location and suitability

- Site will be representative of the pollutants you intend to measure.
- Site is secure but with adequate access.
- Site is appropriately open to all wind directions.
- If you are planning a permanent deployment, check that there is nothing nearby which could change and affect your project – like trees, planned buildings or new roads and other potential interferences.



2. Ensure power is available on site

- Ensure power is available. Both Mains and Solar power can be used, but these will need to be available and/or installed before the monitor arrives.
- When installing power outlets (110 VAC to 230 VAC) for the monitor, they should be weatherproof and installed safely.
- Allow for 2 power outlets, one for the monitor and one for calibration equipment.

NOTE: Outside the United States a power lead with local plug will need to be supplied and wired to a connector supplied with the monitor.



3. Install any additional infrastructure required for the installation

- Mounting location and method has been identified. Most sites will require a way of securely mounting the monitor. Pole Brackets (50.8 mm / 2 “ 304 Stainless U-Bolt) are included to mount the monitor on a pole, anchored to the ground. Small platforms have also been used successfully too.
- If you have ordered Auxiliary sensors (Weather, noise etc.) you will need to provide a means of mounting these also. You will need to supply a pole and fixings to mount the sensor. Siting may be subject to local regulations.
- Check you have the required tools.



4. Confirm communications specification (WIFI and/or cellular)

- Check communications specifications and how the monitor software will be accessed on site
- For cellular access, purchase a dynamic IP network SIM card with at least 1 GB data / month.



5. Plan for your time on site

- When setting up for the first time allow at least four hours on site.
- Allow for travel time to and from the site.
- Confirm site operation times available for access.
- Confirm personal protective equipment (PPE) that may be required on site.



6. Read the user guide

- Familiarise yourself with the assembly steps.
- Confirm the method of data access that will be supplied with the monitor (e.g. Aeroqual Connect or Aeroqual Cloud).
- Send any questions about things you are unsure about to technical@aeroqual.com



7. Write a checklist

- Write your own checklist to ensure a smooth installation and setup.
- Include any reporting requirements that will be required.

2.1.2 After the monitor arrives



1. **Unpack the monitor and inspect**

- Inspect the packaging and monitor for damage. Section 2.3
- Check all items have been supplied

NOTE: Outside the United States a power lead with local plug will need to be supplied and wired to a connector supplied with the monitor.



2. **Mount monitor**

- Mount the monitor to your platform or pole. Section 2
- Attach the PM inlet. Section 2.4.1
- Attach the gas inlet. Section 2.4.3
- Open the door and check that all tubing, power and data connections are secure.



3. **Power on the unit**

- Turn on the unit. Section 2.6
- Check that the Status LEDs on the modules, Embedded PC and Modem (if fitted) are on and green.
- Check that the sampling pump (PM only) or pumps (PM and Gas) are running.



4. **Set up Wi-Fi / Modem and connect to the monitor**

- Connect to Aeroqual Connect Section 4.1
- Connect to Aeroqual Cloud Section 4.2



5. **Check sampling flow rates**

- Put the monitor into Service mode Section 5.1
- Write a comment in the Journal that you are on site for monitor commissioning. Section 6.4
- Check the sampling system for leaks, rectify any leaks. Section 6.5.4
- Check and adjust gas module flow rates to specification. Section 6.5.4.2
- Check PM inlet flow rates and adjust if required. Section 6.5.4.3



6. **Attach optional auxiliary sensors**

- If you have purchased any auxiliary sensors (Weather, Noise) mount these and run the cabling through the external glands and connect to the AUX module. Section 2.7



7. **Document setup in Journal**

- Note in the Journal that commissioning is complete. Section 6.4
- Exit Service mode. Section 5.1

2.1.3 Installation and commissioning

Commissioning is the process of setting up a new monitor to work correctly on site. It is important that the correct procedure for commissioning the monitors is followed to ensure reliable monitor operation and to meet or exceed your data quality objectives. All monitors are supplied with a traceable factory calibration. This calibration is applicable to the commissioning phase and accordingly Aeroqual does not recommend an initial calibration as part of monitor commissioning.

Aeroqual provides a commissioning procedure which should be completed during this period. This report details the tasks carried out during commissioning and can be used to demonstrate correct commissioning to end customers.

The commissioning procedure is available from: <https://www.aeroqual.com/support/resources/aqm-65>

NOTE: Please allow at least 30 min for the monitor to warm up to counter the effects of humidity.

2.1.4 Complete the Commissioning report and provide to customer

This report details the settings of the monitor at the time of commissioning. The completed report should be provided to the customer, along with the factory logbook which is provided with every monitor.

2.2 Pre-planning

The monitors require only basic assembly out of the box.

- Wire a mains AC power cable
- Attach Particle Monitor inlet
- Attach gas inlet (AQS only)
- Attach third party sensors (where supplied)
- Configure modem (where supplied)

Aeroqual recommends these steps be performed in an office or laboratory as part of a quality control check of the monitor to make sure the monitor has arrived undamaged and the flow system, electrical system and communication system are working as expected.

Some of the steps described here will be repeated in the field as part of the installation and commissioning process.

After these steps have been carried out, the Monitor can be safely transported to the monitoring site for installation and commissioning.

Key points to consider for assembly and first power up:

- The monitors run on single-phase mains AC power 100 - 260 VAC (standard), or if required a regulated 12 VDC. For more details see section 2.5.

Configuration used for power calculations: base unit, nephelometer, PM₁₀ sharp cut, O₃ module, modem, heater off / heater on.

- Outside of the United States you need to supply a mains power cable and local plug, Aeroqual recommends a residual current device (RCD) be used to protect against power spikes.
- You will need a Phillips head screwdriver, and if you have an external sensor you will also need a small flat blade screwdriver.
- There is no software to download and install, and no cables are required for communication. Communication to the monitor is through your web browser on your laptop, tablet or smart phone using WIFI.
- If you have purchased a modem, this needs a local SIM (dynamic IP) same as you would have in your smart phone, but you must know the APN of your chosen telecommunications provider, you can look this up: www.apnchanger.org

2.3 Unpacking

The monitors are packaged in a cardboard carton with moulded protective inserts.

Dimensions (L x W x H): 62 x 32 x 55 cm (24.4 x 12.6 x 21.6 “)

Weight: < 14 kg (30.8 lbs) (Configuration used for weight calculations: base unit, nephelometer, PM₁₀ sharp cut, O₃ module, modem, heater off / heater on.

Additional components such as weather or noise sensors will be packaged in additional boxes.

- Examine the ShockWatch® label on the side of the shipping box. If the indicator is red do not refuse the shipment. Make a notification on delivery receipt and inspect for damage. If damage is discovered, leave item in original packaging and request immediate inspection from carrier within 15 days of delivery date (3 days international).
- Verify the serial number label on the documentation matches the serial label on the monitor – the label is located inside the monitor on the bottom right side.
- Verify that all components have been shipped as per the packing slip. Contact your Distributor or Aeroqual if you suspect any parts are missing.



2.4 Assembly

	Online reference	https://training.aeroqual.com/mod/page/view.php?id=624
	Online video	YouTube Channel: Aeroqual Service and Maintenance playlist

2.4.1 Assemble the PM inlet

The particle sampling inlet is easy to assemble by push fitting the various supplied parts together. If no sharp cut cyclone has been ordered, then only a sampling inlet assembly and TSP head will need to be assembled.



Figure 2-1 Particle sampling inlet parts including (L-R): inlet tube, cyclone adaptor, cyclone, TSP head.

2.4.2 Attach PM inlet

- Turn off power to the monitor during this process – see section 2.6.
- If not already fitted, attach a PM inlet O-ring to the aluminium retaining ring and apply a small amount of lubricant.



Figure 2-2 Add the O-ring and a small amount of lubricant.

- Inside the sampling inlet assembly has a sampling tube extending out of it. The sampling tube has a thin film heater further up the shaft which is powered by the black and red cable exiting the bottom of the assembly with white plug on the end.
- Carefully thread the white plug through the PM inlet port on the roof of the monitor.

Continued next page.

IMPORTANT The Particle Monitor ships from the factory with a thin film of tape or coloured cap which protects the inlet, this must first be removed as shown in Figure 2-3.



Figure 2-3 Remove the protective tape or cap from the PM inlet

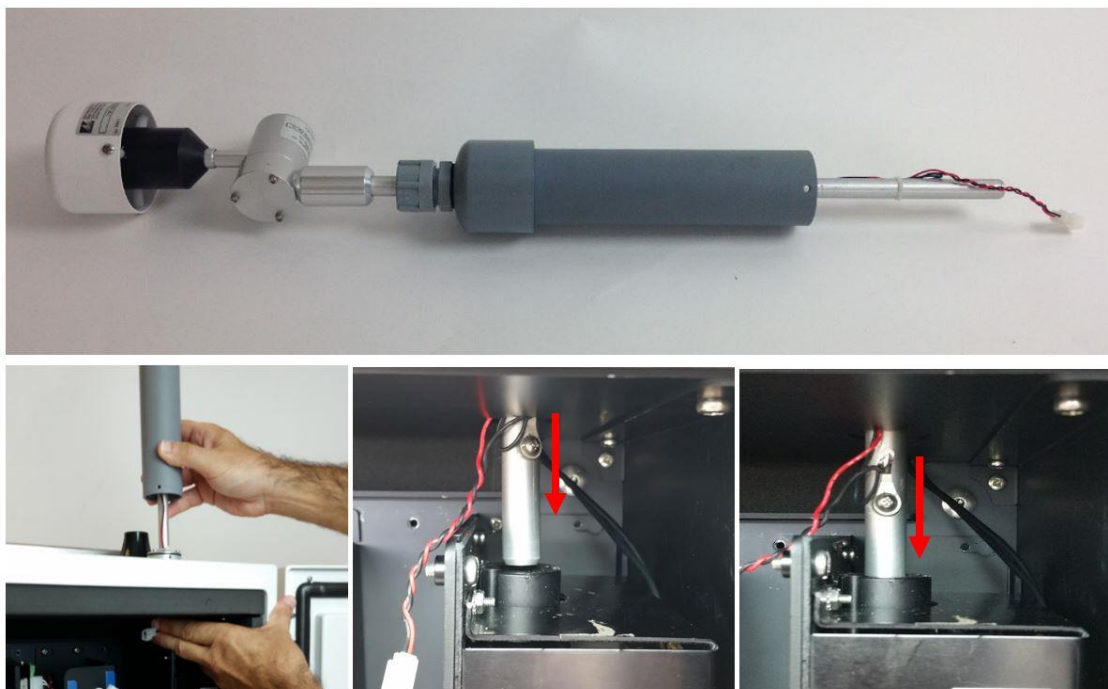

Figure 2-4 Gently feed in the power cable and over the particle engine mounting bracket on the left. The aluminium tube must push all the way into the PM module.

IMPORTANT Ensure sure that the aluminium inlet tube is pushed all the way into the optical engine block.

- If the aluminium tube does not fully push down into the optical engine block, then create more length in the aluminium tube by removing the grey retaining nut and then sliding up the rubber grommet on the top of the inlet. Replace the nut after you have done this.



Figure 2-5 Create more length to the inlet by sliding the black rubber grommet up the tube.

- You need to make sure you have correctly and securely inserted the aluminium tube fully into the optical engine block.
- When you are satisfied the inlet is fully pushed into the engine block, then connect the heater plug on the inlet to the plug coming from the adjacent particle engine control module.
- Insert the three supplied #6-32 UNC retaining screws to secure the inlet to the aluminium retaining ring
- Push the fuse holder in to the “On” position to begin flowing air through the inlet.
- Then perform a leak check and flow check - see Section 6.5.6 and 6.5.7.



Figure 2-6 During field installation, secure the PM inlet using the retaining screws, then plug in the heater

2.4.3 Attach gas inlet (AQS Only)



Figure 2-7 Dust Sentry, Dust Sentry Pro and AQS are supplied with a Swagelok fitting (From Oct 2019).

- The gas inlet is held by a ¼ inch Swagelok compression fitting.
- Attach the gas sampling inlet and perform a flow check to make sure the inlet is fitted correctly, and the sample pump is working properly.
- Fit the supplied Kynar inlet filter to the Swagelok nut at the end of the sample cane.

2.5 Power Requirements



Caution: The high voltage mains supply must be wired by a certified electrician in compliance with local electrical regulations.

The internal power requires regulated 12 VDC to maintain a constant pump speed. An external mains to 12 VDC power supply is fitted under the enclosure and is supplied with either;

- a) a lead with IP rated electrical connector – wiring of mating connector and lead is required, or
- b) a wired mains lead and plug (United States only).

Where possible, visit the site and assess monitor location and access to power source.

2.5.1 AC power source

Both Mains and Solar power can be used, but these will need to be available and installed before the monitor arrives. When installing power outlets (110 VAC to 230 VAC) for the monitor, they should be weatherproof and installed safely. Install two power outlets, one for the monitor and one for calibration equipment.

NOTE: Outside the United States a power lead with local plug will need to be supplied and wired to a connector supplied with the monitor – see section 2.5.2.

2.5.2 Wiring the power supply connector

1. Locate the power connector terminal which is situated outside the enclosure at the bottom. The power supply will already be wired to the connector however the cable to connect to mains power needs to be wired.

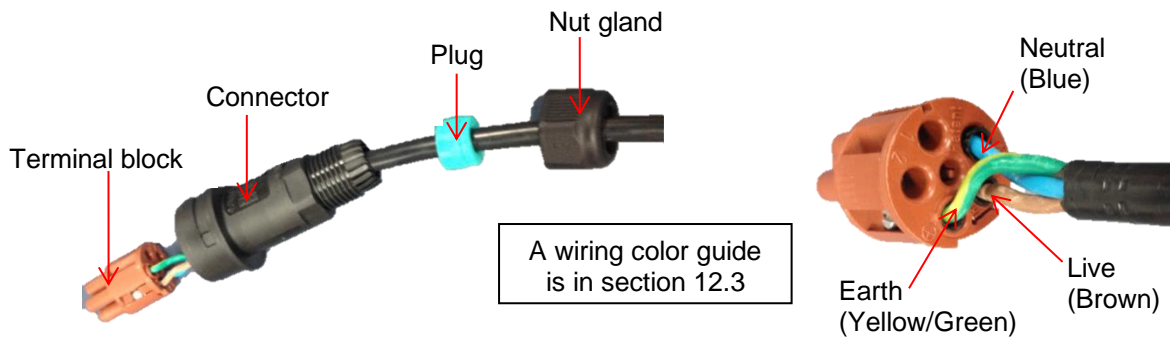

2. Feed the power cable through the nut gland plugs and connector and wire the cable to the terminal block according to the diagram.

3. Reconnect into the connector ensuring the plugs are fitted securely and the nut gland tightened.

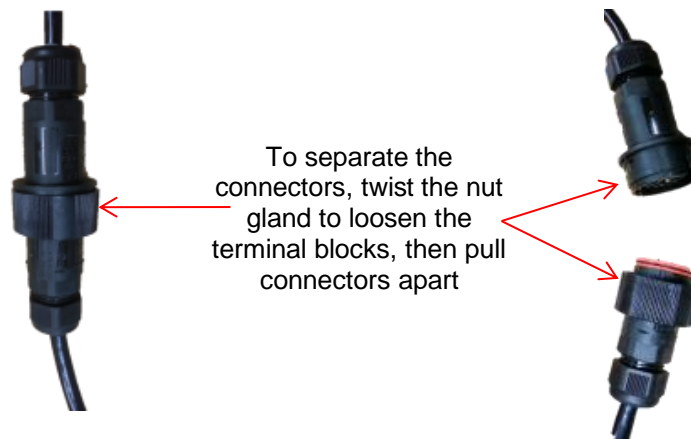

2.5.3 DC power source

Occasionally mains AC power is not available at the site where the Monitor is installed, and battery ..
When specified, a DC-DC converter and battery voltage monitor for battery powered projects are supplied connected to the power and data chassis.

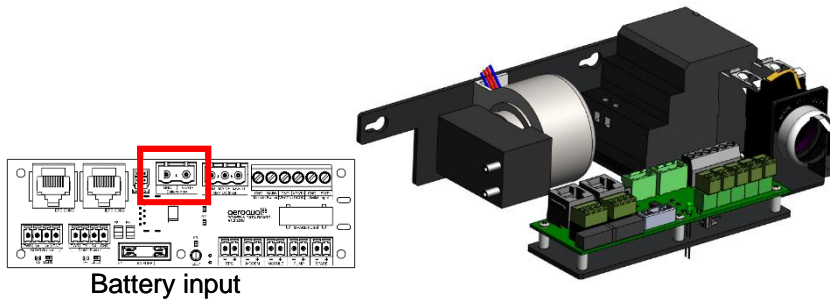

Figure 2-8 DC-DC converter and battery voltage monitor

2.6 Powering On/Off

The monitor can be easily powered on or off using the rotary switch located at the bottom right hand corner inside the enclosure. Older units use a fuse switch – see section 2.6.1.



The rotary power switch was introduced in October 2019. It is used to turn the power off, power the monitor by AC mains supply, or power the unit by DC source such as battery solar.

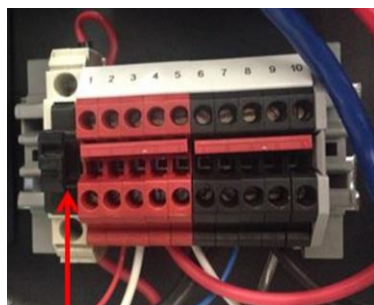

Figure 2-9 The rotary switch in the off position

2.6.1 Fuse switch (Pre-Oct 2019)

NOTE: Pull the 12 VDC fuse out from the fuse holder “off position” before testing the mains connection. See Figure 2-10.

	Online reference	http://training.aeroqual.com/mod/page/view.php?id=623
	Online video	YouTube Channel: Aeroqual Service and Maintenance playlist



12 V DC fuse pushed in, the “on” position

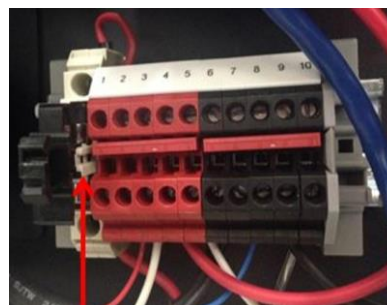

12 V DC fuse pulled out, the “off” position

Figure 2-10 The 12V DC fuse can be pulled out to turn off the monitor or pushed in to power the monitor

Push in the 12 DC fuse to the “on” position as shown on the left in Figure 2-10. The pump/s will start and the ePC will boot up with a series of beeps. The green power LED lights should light up on the modules when power is applied, this confirms the power is being correctly delivered to the modules.

2.7 Connecting auxiliary sensors

External third-party sensors such as weather stations and noise meters are easily connected to the monitor. To connect third party sensors, feed the sensor cable through a free cable gland on the underside of the monitor and wire it to a plug in an available COM port (indicated below). third party sensors need to be configured through Aeroqual Connect or Cloud – see section 2.7.2.

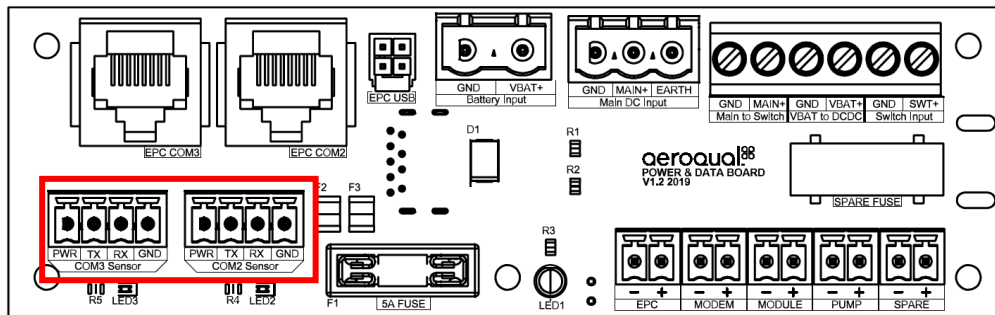

2.7.1 Auxiliary sensor wiring diagrams

NOTE: To check the operation of the third-party sensor in your office or laboratory prior to site installation it is not required to feed the cable through the gland.

Gill Instruments Windsonic	MetOne MSO weather station	Vaisala WXT536 weather station	Cirrus MK427 noise meter	Li-Cor LI-200 Pyranometer
Green (V supply +) Yellow (TXD) Brown (RXD) White (V supply -), Braid (Signal)	Red (+12V DC) White (RS-232 TX) Brown (RS-232 RX) WHT/BRN (Shield), GRN (Signal common), BLK (Pwr com)	Brown (Vin+ for operating) Yellow (Vin+ for heating) Blue (Data out TxD) White (Data in RxD) Red (GND for Vin+), Green (GND for data), Pink (GND for Vh+)	Separate AUX module required, see section 2.7.3	Separate AUX module required, see section 2.7.3
PWR TX RX GND	PWR TX RX GND	PWR TX RX GND		

2.7.2 Configuring auxiliary sensors using vAUX

In the past, all third-party sensors were connected to an AUX module. From October 2019 the AUX was replaced with a vAUX (Virtual AUX) solution. With these changes, third party sensors need to be configured through Aeroqual Connect or Cloud.

Configuration Steps

In the Configure Instrument screen, choose a sensor driver from the drop-down list under External Sensors.

The screenshot shows the 'Configure Instrument' screen for 'PDEV-TestLongRunning-05'. The 'External Sensors' column has a dropdown menu open, showing options like 'BSWA 308', 'Gill WindSonic', 'Vaisala WXT530', 'Battery Monitor', and 'MetOne MSO'. The 'Sensors' column shows a list of active sensors including NO2, O3, PM2.5 raw, TEMP, RH, and DP.



After selecting the driver, a new section with the driver will appear in column four and all sensors supported by the driver are added into active sensor list in the Sensors column. Choose the serial port that the sensor is connected to from the drop-down list under External Sensors.

The screenshot shows the 'Configure Instrument' screen after a driver has been selected. The 'External Sensors' column now shows a section for the selected driver with a 'Select a port' dropdown menu set to 'COM 1'. The 'Sensors' column has been updated with additional sensors like 'Active Gill WindSonic Sensors'.

Click the Save button at the bottom of the page to save the configuration.

The dialog box has a title 'Save changes?' and two buttons: 'Cancel' and 'Save'.

2.7.3 Connecting auxiliary sensors (Monitors pre-Oct 2019)

	Online reference	http://training.aeroqual.com/mod/page/view.php?id=625
	Online video	YouTube Channel: Aeroqual Service and Maintenance playlist

On monitors' pre-Oct 2019, external sensors such as weather stations and noise meters need to be wired to the green connector plug on the front of the auxiliary module. To connect third party sensors, feed the sensor cable through a free cable gland on the underside of the monitor and wire it to the required auxiliary module according to the wiring diagrams – see section 2.7.3.2.

2.7.3.1 AUX module (Monitors pre-Oct 2019)

In monitors pre-Oct 2019, an AUX module is used to provide power to an external sensor and to process data from the sensor. The AUX module uses a 12-way green connector to connect to the external sensor.

When you are happy with the wiring then apply power, and log on to the Aeroqual Connect software as described in section 4.1 Aeroqual Connect (via Direct WIFI / LAN). After some minutes you should see the parameters associated with the third-party sensor being shown in the software in the APP “Configure Instrument”, view settings then the active sensor column.

To see the data, go to “Manage Data”, then Charts or Table, adjust the “Averaging Period” as required.



NOTE: Retain the certificate of compliance that is shipped with the monitor.

2.7.3.2 Auxiliary sensor wiring diagrams (Monitors pre-Oct 2019)

IMPORTANT The auxiliary module orientation may vary, observe the correct numbering order as labelled on the green connector.

Gill Ultrasonic Wind Sensor



Met One MSO Weather Sensor

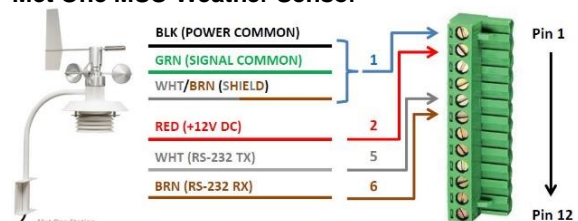

Vaisala WXT536 Weather Sensor

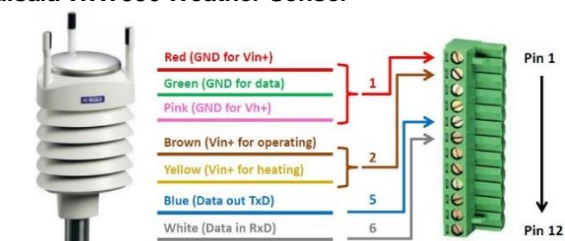

Cirrus MK427 Noise Sensor

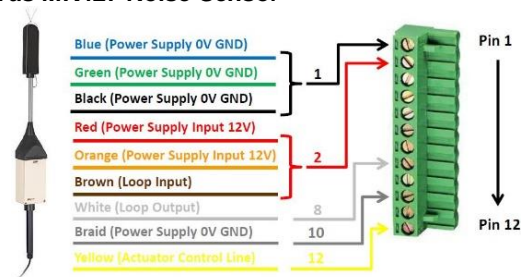

Novalynx Silicon Pyranometer

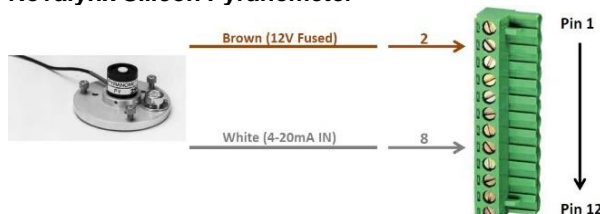

	Online reference	training.aeroqual.com DM 1.3 Tech training Section 2.3
---	------------------	--

3 Mounting and Site Positioning Guidelines

It is important that the positioning of the monitor is suitable to yield data which is representative of that specific location.

3.1 Mounting

The monitor comes with; 2 x mounting brackets, 3 x U-bolts for 45 mm (1½") diameter poles, 2 x metal bands for pole diameters between 21 - 44 mm (1" - 1½"), and 2 x metal bands for pole diameters between 59 – 82 mm (2 - 3"). The same brackets are used for both pole and wall mounting. To wall mount the monitor the brackets are screwed into the wall instead of using the U-bolts.

For pole mounting:

1. Secure top mounting bracket at a suitable height using the U-bolts or metal bands provided
2. Fix lower mounting bracket to the Dust Sentry chassis with screws
3. Hang the monitor on the top mounting bracket
4. Place U-bolt or metal band through lower mounting bracket
5. Secure bottom mounting bracket using the U-bolts or metal bands provided

NOTE: Only one U-bolt or metal band is required to secure the bottom bracket.

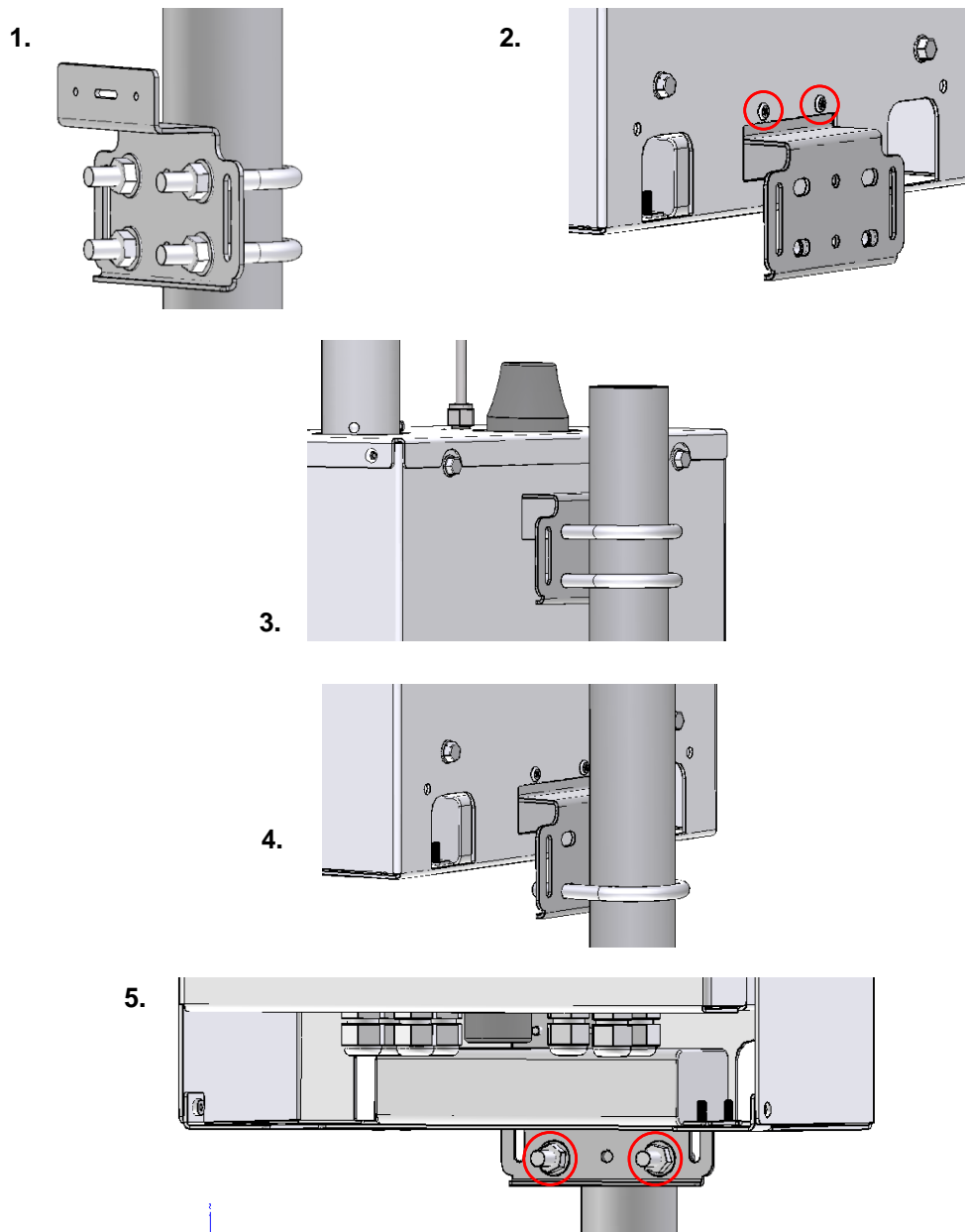

3.2 Inlet height

- If monitoring is related to human exposure, the sampling inlet height should be positioned in the “breathing zone”. This is located between 2 and 15 m (6.6 and 49.2 ‘) above ground level.
- If monitoring is related to specific emission sources, the position of the sampling inlet can be more flexible. It is more important that there is no obstruction between the approaching air from the emission source and the sampling inlet.
- If more than one monitor, or any other particulate instrument, is being used at the site, the height of the inlets should be uniform.
- If the monitor inlet is the highest point at the site, a lightning rod must be installed to prevent damage to the unit during electrical storms.

3.3 Measurement Interference

- The meteorological conditions of the site should be taken into consideration when positioning the monitor. For example, there should be no obstruction to the air flow in the predominant wind direction. A minimum clear sky angle of 120 degrees is recommended.
- The inlet should be at least 1 meter away from any objects that could potentially influence the airflow characteristics e.g. trees, vertical surfaces or walls.
- Avoid overhead high-voltage cables which may cause electrical interference with the sampling equipment.
- Demolition/construction activities and change to normal transport patterns due to road works etc. can significantly affect the data. Ensure a record of such events is kept to account for unexpected peaks in concentration.

3.4 Safety

- The intended data capture rate should be considered when positioning the monitor. If data capture above 90 % is essential, the unit should be in an area which has 24-hour access available.
- The positioning should allow for routine maintenance checks to be performed safely by personnel.
- If using a tripod, ensure the tripod legs are bolted to the ground to prevent the unit from falling.
- Ensure the monitor is in a secure location to avoid vandalism or theft.

3.5 Surveyor’s tripod mounting

If needed, Aeroqual can supply a mounting kit that attaches the AQS 1, Dust Sentry or Dust Sentry Pro to a standard surveyor’s tripod. The kit includes one mounting plate, 8 x M4 hex head bolts and nuts, and 6 pegs. You supply your own surveyor’s tripod with standard 5/8” x 11 mounting screw.

1. Lay your monitor on a flat surface.
2. Using the 8 x M4 hex head bolts and nuts, bolt the mounting plate to the monitor through the slots in the bottom of the monitor’s solar shield.



3. Place the tripod in the desired location and secure it to the ground using the 6 provided pegs.



4. Attach the monitor to the tripod by screwing the tripod's mounting screw through the threaded hole in the mounting plate. Note: Keep the mounting screw as close to the center of the tripod as possible so that the weight of the monitor is centered over all three legs.



5. Check the tripod is firmly secured to the ground. If it's not, there is a danger of the monitor falling over due to wind. If the supplied pegs aren't suitable for the ground type, you might need to find another way to secure the legs.
6. For extra security, attach guy wires to the four holes in the corners of the mounting plate.
7. Check the tripod attachment screw is firmly tightened and that the monitor is centered on the tripod.



4 Connectivity

The monitors use an industrial embedded PC (ePC) for data logging and monitor control. A cellular modem can be fitted to facilitate remote connection and support from Aeroqual technical support – see section 4.2.2 Connecting using a cellular modem.

There are two ways to connect to your monitors:

- **Aeroqual Connect (via Direct WIFI / LAN)** for initial set up and when access to the internet is limited;
- **Aeroqual Cloud (via Network WIFI / Modem)** for remote access, visibility of all your monitors, and remote technical support from Aeroqual Care.

Aeroqual highly recommends every monitor is connected to Aeroqual Cloud for the best user experience, additional data features, and Aeroqual Care.

Engineers who need to perform service or data analysts who need to view or download data can do so using a web browser on their PC, tablet or smart phone. There is no software to download and install.

Data Security

The data belongs to you. We look after it in the same way that a bank looks after your money. Who you let access your data is entirely up to you – our job is to carry out your instructions.

If you do choose to store data with us, then here are some of the security assurances we provide:

- We use only ISO 27001 approved data centres
- Infrastructure is monitored and protected 24/7
- Data is accessed via a secure website with 256-bit SSL encryption
- User defined passwords

4.1 Aeroqual Connect (via Direct WIFI / LAN)

Aeroqual Connect contains all the tools necessary to view and download the data and maintain and calibrate a single monitor.

No internet connection is required for Aeroqual Connect. Aeroqual Connect is always running on the monitor and can be accessed via WIFI through an internet browser on any device, there is no software to install.



Figure 4-1 Aeroqual Connect Home page

4.1.1 Connect to Aeroqual Connect via Direct WIFI

A few minutes after powering on, you should see a new WIFI network in your device's list of WIFI networks. The WIFI name (SSID) will match your serial number, connect to this network using the password below.

- WIFI SSID: **DS DDMMYYYY-XXX** or **AQS1 DDMMYYYY-XXX**

- Password: **Aeroqual**

NOTE: *If you are accessing the internet on your device using WIFI, you will lose your internet connection.*

4.1.2 Connect to Aeroqual Connect via LAN

The monitors can be added to a LAN, in two ways:

- Using the WIFI function to connect to a WIFI network
- Using an Ethernet cable to plug into a LAN network router

When connected to the LAN, the monitor will automatically be assigned an IP address by the LAN router.

You must find out what this IP address is so you can connect to the monitor. The WIFI or wired LAN IP address will likely be in the format: **192.168.XXX.XXX**

If your laptop also has access to the same LAN, then this IP address can be typed into a browser address bar and a connection to the monitor can be established over the LAN connection.

4.1.3 Access your monitor on Aeroqual Connect

After connecting your monitor to your device, open an internet browser window and enter **10.10.0.1** in the address bar. You should see the Aeroqual Connect login screen. Log in with the default username and password provided.

- URL: **10.10.0.1**
- Username: **administrator**
- Password: **aqmadmin**

NOTE: *Depending on your device WIFI settings, and how long you take to enter complete the steps above, your device may reconnect to the previous WIFI connection.*

After logging in to Aeroqual Connect, you will be presented with a screen with five 'apps'; Manage Data, Calibration and Service, Configure Instrument, Diagnostics and Advanced, and Administration. You are now accessing your monitor in "Access Point" mode.

Next, open the Administration app and create a new user and secure password, then delete the default username and password.

4.2 Aeroqual Cloud (via Network WIFI / Modem)

Aeroqual Cloud is cloud-based software. It gives you and other trusted users access to all your monitors via secure third-party servers. Use Cloud to:

- Communicate with your monitor from anywhere in the world at any time
- Use advanced charting features such as wind roses and pollution roses
- Receive fast and comprehensive technical support from your Aeroqual distributor or Aeroqual technical support team.
- Automatically export data to multiple users via email or to an FTP server.
- Securely back up data in case of local data access issues.
- Maintain service records in the Cloud Journal for auditing and engineer certification.

Connection to Aeroqual Cloud makes technical support fast and efficient for the end user.

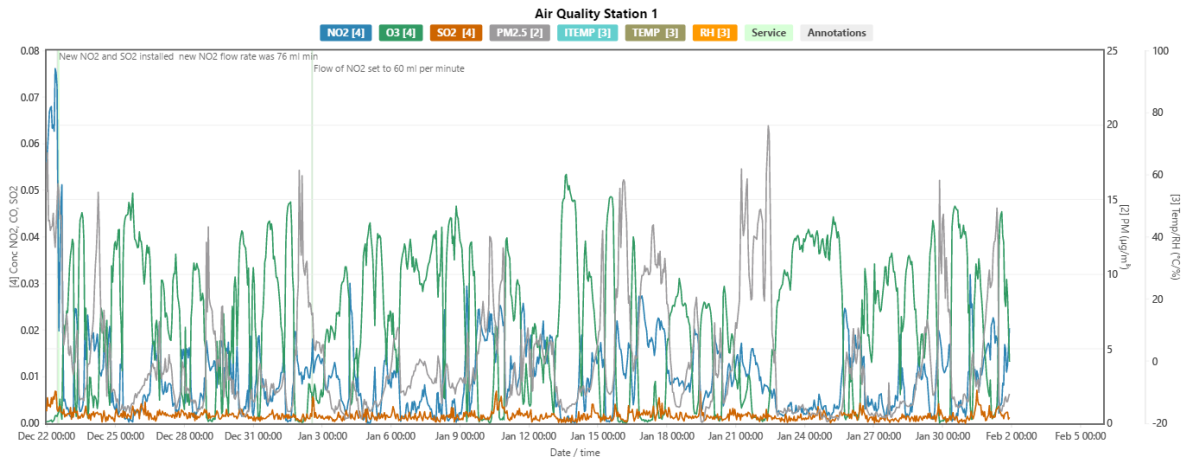

Figure 4-2 Aeroqual Cloud has many useful features such as plotting multiple channels on a single graph

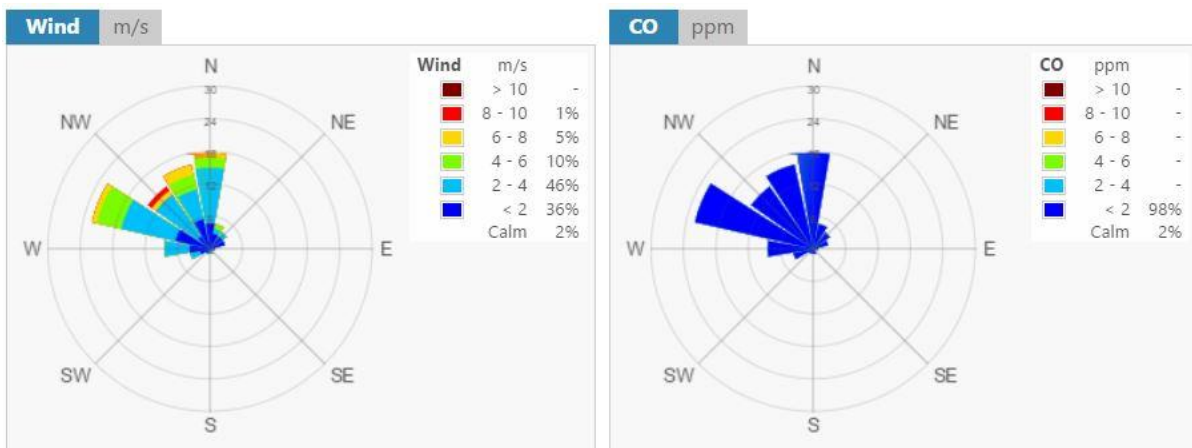

Figure 4-3 Generate advanced graphical presentations such as wind roses and pollution roses.

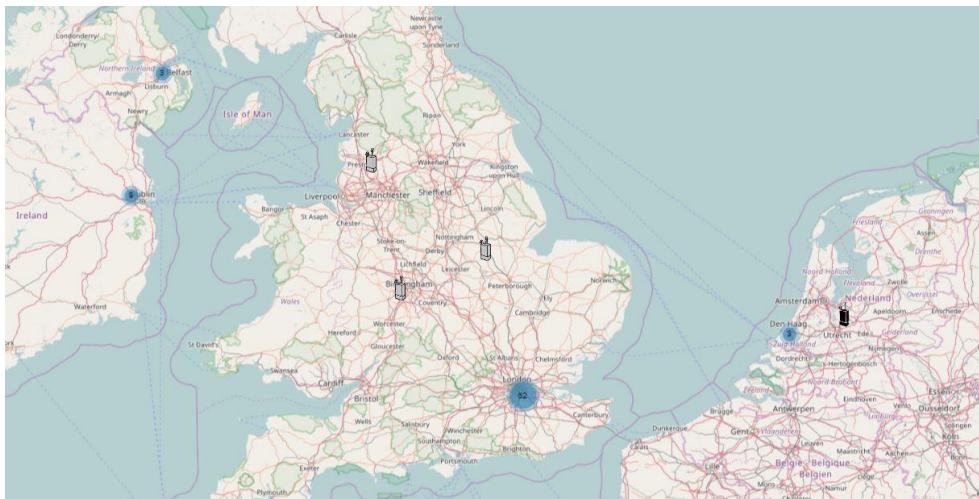

Figure 4-4 Select multiple monitors by region, and plot data from multiple different monitors on the same graph.



Figure 4-5 Receive SMS text alerts directly to your smart phone or by email.

4.2.1 Connecting over a local area network (LAN)

The monitors can be added to a LAN, in two ways:

- The WIFI function of the monitor is used to connect to a WIFI network that is connected to the internet.
- An Ethernet cable is used to connect the monitor to router that is connected to a LAN.

When this happens, the monitor will automatically be assigned an IP address by the LAN router.

You must find out what this IP address is so you can connect to the monitor and access the monitor software. The WIFI or wired LAN IP address will likely be in the format: 192.168.XXX.XXX

Figure 4-7 shows the Connect software with an assigned IP address in the address bar in the browser.

If your laptop also has access to the same LAN, then this IP address can be typed into a browser address bar and a connection to the monitor can be established over the LAN connection.

4.2.2 Connecting using a cellular modem for remote communication

The monitors can be fitted with a cellular modem connected to a built-in cellular antenna on the outside roof of the enclosure. The modem requires a SIM card and the modem must be configured.

4.2.2.1 Set up Sierra RV50X modem



Mobile Network Operator Certification for the RV50 (Pending for the RV50X)

- Verizon Wireless
- AT&T
- Sprint
- T-Mobile USA
- US Cellular
- Rogers
- Bell
- Telus

Antennas

On the Sierra RV50X, there are 3 antennas:

1. **Cellular antenna:** Major cellular antenna (connected to built-in antenna on monitor)
2. **Diversity antenna:** For 3G networks, the second antenna operates as a diversity antenna, providing a second receive path. For 4G networks, the second antenna operates as a MIMO antenna, providing a second receive path and a second transmit path.
3. **GPS antenna**

Dual SIM

The AirLink RV50X Series gateway has two SIM card slots. You can decide which slot is the Primary SIM card. When the gateway is powered on or reboots, it automatically connects to the network associated with the Primary SIM card. If no card is present in that slot, it connects to the network associated with the Secondary SIM card. If configured to do so, data usage is tracked independently on both SIM cards. SIM PIN configuration is also available for both SIM cards. This feature allows users to install SIM cards for two different network operators, use one SIM card initially and later change network operators by configuring the new SIM card to be the Primary SIM card.



Power saving features

This feature optimizes idle power consumption. Recommended for customers who require the best power consumption efficiency, for example; battery or solar powered applications. Enabling this feature saves energy by reducing performance where possible.

Interface Priority

Rank the available WAN interfaces by selecting the order of priority. The highest priority interface will become the default route for IP traffic. The default order of priority is:

- Ethernet — First
- Cellular — Second

If the highest-priority interface is not available, the gateway attempts to connect to the second-highest priority interface. Interface priority is evaluated as follows:

- Ethernet — Does the gateway have an IP address from the router?
- Cellular — Can the gateway access the Mobile Network Operator's network?

Bandwidth Throttle

This feature helps you manage your data account by allowing you to configure the AirLink gateway to restrict the real-time available bandwidth. You can:

- Place limits on traffic (uplink, downlink, or both)
- Allow for burst of traffic on the uplink, downlink, or both, while still maintaining the over-all desired bandwidth limit

Traffic that exceeds the limits is dropped. Status fields keep running tallies of data sent and received and the number of uplink and downlink packets dropped.

APN

Note: The first time you power on the AirLink device, ALEOS automatically selects the most commonly used APN for the Mobile Network Operator identified on the inserted SIM card. This APN is used if no other APN is selected or configured.

The APN the gateway is using for authentication on the mobile network is displayed.

- If a User Entered APN is configured, the User Entered APN is displayed.
- If there is no User Entered APN configured, an automatically selected APN is displayed.
- When the Backup APN is configured, the APN in Use displays the configured Backup APN when it is being used for authentication on the mobile network

Dynamic DNS

With IP Manager, the gateway's WAN IP is included in the update packet sent to the IP Manager server, so IP Manager always links the gateway's WAN IP address to the domain name configured on the gateway.

4.2.2.2 Set up MOXA G3111 HSPA modem

	Online reference	http://training.aeroqual.com/mod/page/view.php?id=702
---	------------------	---

- Aeroqual supplies an optional cellular modem (MOXA G3111 HSPA) for remote communication. This is Aeroqual part number R38. This must be correctly configured to work on the local telecommunications network in your country.
- The modem requires a standard SIM card (dynamic IP) which you can buy from a cell phone store. The SIM card fits in a slot underneath the modem as shown in Figure 2-6.

- You must know the APN of your cellular provider, you can find out the APN by going to www.APNChanger.org and looking up your country and cellular provider.
- Directly connect the MOXA modem to your PC using an Ethernet cable.
- Then enter the APN into the correct field through the MOXA configuration interface shown in Figure 2-6.



Figure 4-6 The MOXA modem uses a SIM card and it must be configured for use.

The Ethernet Mode must be set to Auto DHCP client to use the MOXA modem, as shown in Figure 4-9 (c). Other options for connecting to the monitor

There are several options to establish a communication connection to the monitors. These require the communication settings to be changed in the Configure Instrument App shown in Figure 4-7. The communications settings are entered in to the third column. Details of each of these communication methods and how to set them up in the Configure Instrument App are given in the online training.

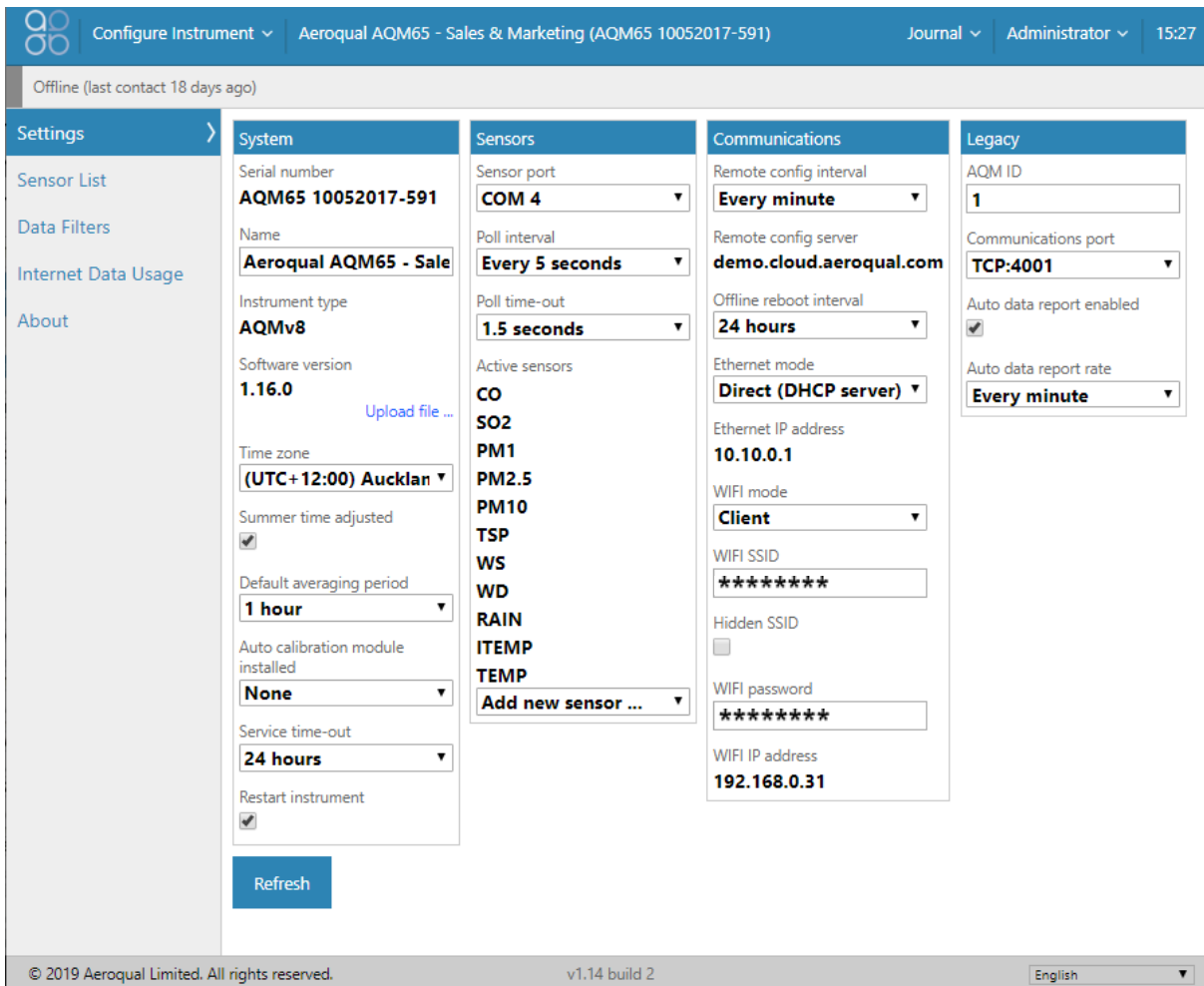

Figure 4-7 Column three in the Configure Instrument app control the communication and connection settings

4.2.3 Ethernet connection

The ePC has a separate wired Ethernet connection, this can be used in several ways:

- To directly connect to a PC
- To connect to a wired LAN via a router
- To connect to an IP modem to provide cellular communication.

The WIFI connection and Ethernet connection are independent from each other, both can be used at the same time. The recommended configuration for connection is to set the WIFI mode to Access Point and the wired Ethernet to Client mode to use with the modem.

To use an ethernet cable, ensure the blue Ethernet cable from the ePC is plugged in to the Ethernet plug in the bottom of the instrument, as shown in **Figure 4-8**. Ethernet mode is set to DHCP (server) in this method.



Figure 4-8 To establish a direct connection, a laptop must be connected to the ePC using an Ethernet cable

4.3 Communication settings

Communications	Communications	Communications	Communications
Remote config interval Every minute	Remote config interval Every minute	Remote config interval Every minute	Remote config interval Every minute
Remote config server Production server	Remote config server Production server	Remote config server Production server	Remote config server Production server
Offline reboot interval Disabled	Offline reboot interval Disabled	Offline reboot interval Disabled	Offline reboot interval Disabled
Ethernet mode Auto (DHCP client)	Ethernet mode Auto (DHCP client)	Ethernet mode Auto (DHCP client)	Ethernet mode Direct (DHCP) server
Ethernet IP address 192.168.127.10	Ethernet IP address 192.168.85.177	Ethernet IP address 192.168.127.10	Ethernet IP address 10.10.0.1
WIFI mode Access point	WIFI mode Access point	WIFI mode Client	WIFI mode Client
WIFI SSID AQM65 12031016-444	WIFI SSID AQM65 12031016-444	WIFI SSID Office WIFI	WIFI SSID Office WIFI
WIFI password Aeroqual	WIFI password Aeroqual	WIFI password Office_WIFI_P@#\$wrD	WIFI password Office_WIFI_P@#\$wrD
WIFI IP address 10.10.0.1	WIFI IP address 10.10.0.1	WIFI IP address 192.168.0.158	WIFI IP address 192.168.0.158
a	b	c	d

Figure 4-9 The different connection types require different settings in the Configure Instrument app

- The Ethernet mode is set to Auto (DHCP client). In this configuration the modem can be used. The modem will assign IP address **192.168.127.10** to the ePC. The WIFI mode is set to Access Point so a direct connection to the EPC can be made over local WIFI.
- The Ethernet mode is set to Auto (DHCP client). In this example the ePC has been plugged in an office router using an Ethernet cable. The router has assigned IP address **192.168.85.177** to the ePC.

The WIFI mode is set to Access Point so a direct connection to the ePC can be made over local WIFI, the Ethernet mode is set to Auto (DHCP client). In this configuration the modem can be used. The modem will assign IP address **192.168.127.10** to the ePC.

- c) The WIFI mode is set to Client and is connected to the office WIFI network. The ePC has been given a WIFI IP address **192.168.0.158** by the router This IP address can be entered directly in the browser to connect to the monitors.
- d) The Ethernet mode is set to Direct (DHCP Server). In this configuration a laptop can be directly connected to the ePC using an Ethernet cable. Enter **10.10.0.1** to connect directly to the monitors.

NOTE: *Should you need to reset the communication settings, see the following section, Section 4.4.*

4.4 Resetting the communication settings back to factory settings

The monitor communication settings can be set back to factory defaults.

One situation where this might be useful is if the WIFI SSID name or password has been incorrectly entered and therefore the ePC cannot establish a connection to the local WIFI network.

The WIFI settings can be set back to Access Point mode and the monitor will again appear as a WIFI network. Depending on the version of Aeroqual Connect you are using, the SSID name will appear as the monitor “**serial number**” or as “**Aeroqual AQM**”, the reset WIFI password will be “**Aeroqual**”.

To achieve this, you will need a USB flash drive.

1. Create a file on the flash drive called **.resetnetwork.aqm** (yes there is a “dot” at the beginning of the file name).

The file extension must be **.aqm** it cannot be an **.aqm.txt** file.

In Windows OS you can create a new **.txt** document and give the file name **.resetnetwork.aqm**

Check the Type column to make sure it is an **.aqm** file. You might need to unhide file extensions and delete the **.txt** from the end of the file name. Figure 4-10 shows the correct file.

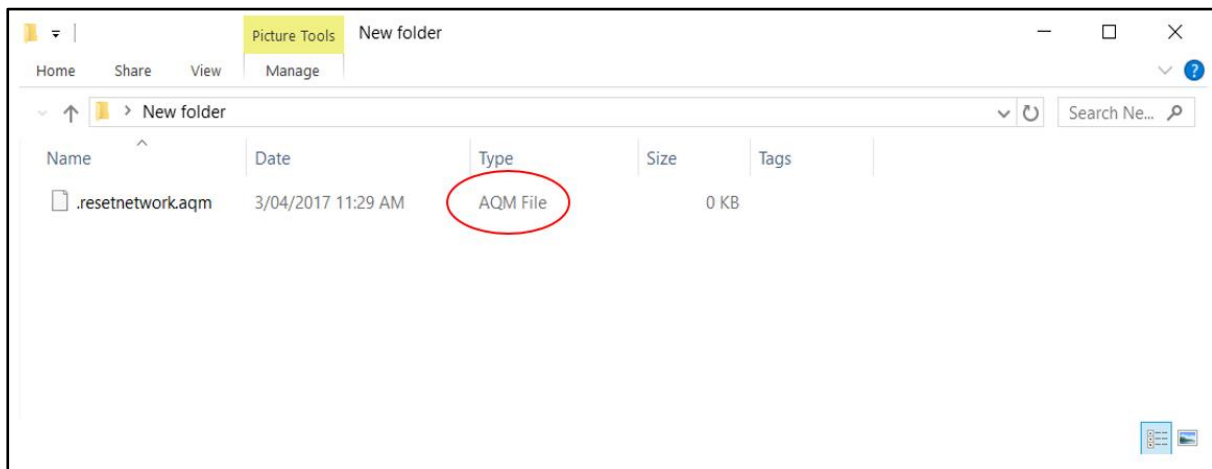

Figure 4-10 Create an empty file called .resetnetwork.aqm

2. Then insert the USB drive into any of the USB ports on the ePC.
3. Wait several minutes, the ePC will reboot automatically and then you should see a WIFI network appear called as either the monitor “**serial number**” or “**Aeroqual AQM**” with password **Aeroqual**.

You can then remove the USB stick.

5 Operation

Data visualisation, monitor configuration, calibration and control of user access is achieved using apps which are accessible from the main page.

Access to the apps, and the individual features within each app is controlled by the monitor licence and the user privileges for the different user types, which are described in Section 5.5.



Figure 5-1 The landing page of Connect after login shows the available apps

5.1 Manage Data

The Manage Data app is used to view data within the browser and to download data (export) data for use in other software. The available features in the Manage Data app will depend upon the monitor licence and the user permission level. The features within the Manage Data app appear in a column on the left-hand side of the screen.

Feature	Aeroqual Licence	User permission required
Charts	Connect / Cloud	User or higher
Table	Connect / Cloud	User or higher
Download data	Connect / Cloud	User or higher
Auto Export	Cloud	Engineer or higher
Manual sync	Connect	Engineer or higher

Table 5-1 Software tools available to different user permissions

5.1.1 Charts

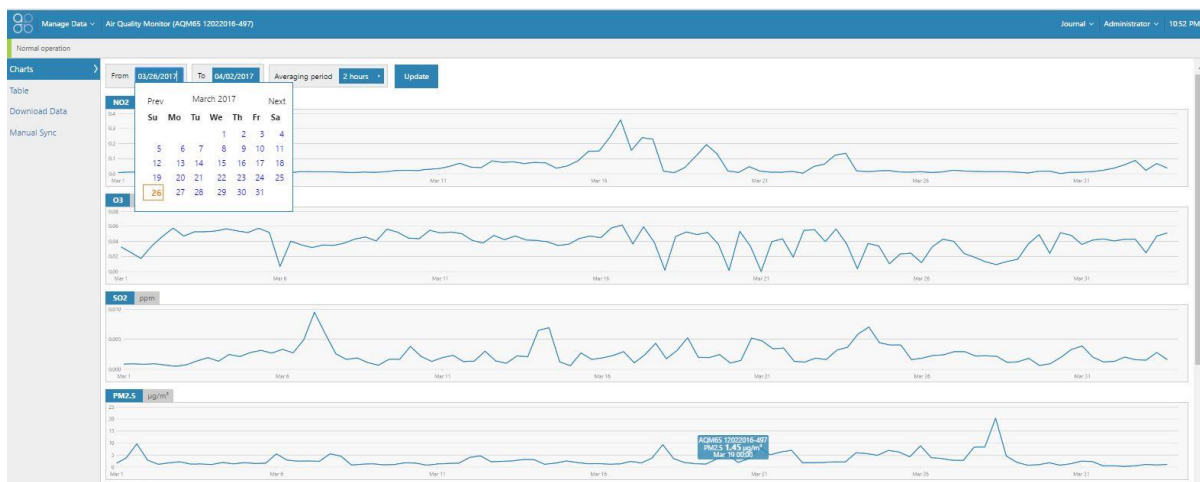

Figure 5-2 The charts tool, in the Manage Data app shows each data channel in a stack of charts

5.1.2 Table

The data from each module can be viewed on screen in a Table. The from and to dates can be selected using a calendar tool, and the averaging period such as daily, hourly or minute can also be selected.

Time	O3 (ppm)	SO2 (ppm)	PM2.5 (µg/m³)	ITEMP (°C)	TEMP (°C)	RH (%)
4/2/2017 10:00 PM	0.000	0.001	1.18	30.0	11.13	47.0
4/2/2017 9:00 PM	0.046	0.001	1.22	30.0	11.19	46.6
4/2/2017 8:00 PM	0.049	0.003	1.18	30.0	12.33	43.1
4/2/2017 7:00 PM	0.051	0.003	1.16	30.0	13.60	39.0
4/2/2017 6:00 PM	0.055	0.001	1.04	30.0	15.70	33.2
4/2/2017 5:00 PM	0.053	0.001	1.17	30.0	17.25	32.0
4/2/2017 4:00 PM	0.053	0.001	1.19	30.0	18.07	32.7
4/2/2017 3:00 PM	0.052	0.003	1.11	30.0	19.75	29.9
4/2/2017 2:00 PM	0.121	0.053	0.002	30.0	19.44	29.7
4/2/2017 1:00 PM	0.090	0.051	0.002	30.0	18.91	33.8
4/2/2017 12:00 PM	0.076	0.050	0.005	30.0	16.99	40.1
4/2/2017 11:00 AM	0.055	0.047	0.004	30.0	14.73	46.4
4/2/2017 10:00 AM	0.034	0.045	0.002	30.0	12.24	52.4
4/2/2017 9:00 AM	0.021	0.040	0.002	29.9	10.52	58.0
4/2/2017 8:00 AM	0.012	0.038	0.002	29.9	8.85	63.4
4/2/2017 7:00 AM	0.006	0.036	0.001	29.9	6.10	73.9
4/2/2017 6:00 AM	0.011	0.015	0.001	29.9	5.32	80.6
4/2/2017 5:00 AM	0.014	0.013	0.001	29.9	5.92	81.6
4/2/2017 4:00 AM	0.014	0.020	0.002	29.9	5.76	81.1
4/2/2017 3:00 AM	0.015	0.021	0.002	29.9	5.83	81.3
4/2/2017 2:00 AM	0.024	0.024	0.002	29.9	5.54	79.7

Figure 5-3 The table tool in the Manage Data app shows the data in a table with user configured date range and averaging

5.1.3 Download data

The data can be downloaded by selecting a From and To date and Averaging Period. The format is comma separated values (.csv). This file format can easily be opened in Microsoft Excel.

Time	NO2 (ppm)	O3 (ppm)	SO2 (ppm)	PM2.5 (µg)	ITEMP (°C)	TEMP (°C)	RH (%)	Inlet
1/01/2017 0:00	0.006	0.033	0	1.89	29.9	5.92	75.8	Sample
1/01/2017 0:01	0.006	0.033	0	1.78	29.6	5.97	75.6	Sample
1/01/2017 0:02	0.006	0.033	0	1.7	29.7	5.89	74.1	Sample
1/01/2017 0:03	0.006	0.033	0	2.17	30.1	5.95	70.7	Sample

Figure 5-4 The download data tool in the Manage Data app allows the data to be downloaded at user configured date range and averaging

5.1.4 Manual sync

The manual sync feature allows all the data, and diagnostics and journal entries to be **downloaded from Connect to a PC**. The manual sync file cannot be read by any software. The manual sync file is later **uploaded from a PC to Aeroqual Cloud**.

This feature is used if the Monitor does not have an active data connection to Aeroqual Cloud at the monitoring site but the data is required to be in Aeroqual Cloud for data storage and so all stakeholders can access the data.

Figure 5-5 shows the Manual Sync download tool in Aeroqual Connect and the Manual Sync upload tool in Aeroqual Cloud.

NOTE: You might need to manual sync multiple times. The first time the “From Date” is “1900”, then it creates a file with a maximum number of records of 1 million. Therefore, the file might only

synchronize for a limited dataset. At the end of that sync the “From Date” will show up to where the last data was downloaded. You run the sync command again and it gives you a new file starting at that date and including the max number of records. You keep running this process until you get to today’s date.

These files are then uploaded one by one using the manual sync upload tool in Aeroqual Cloud.

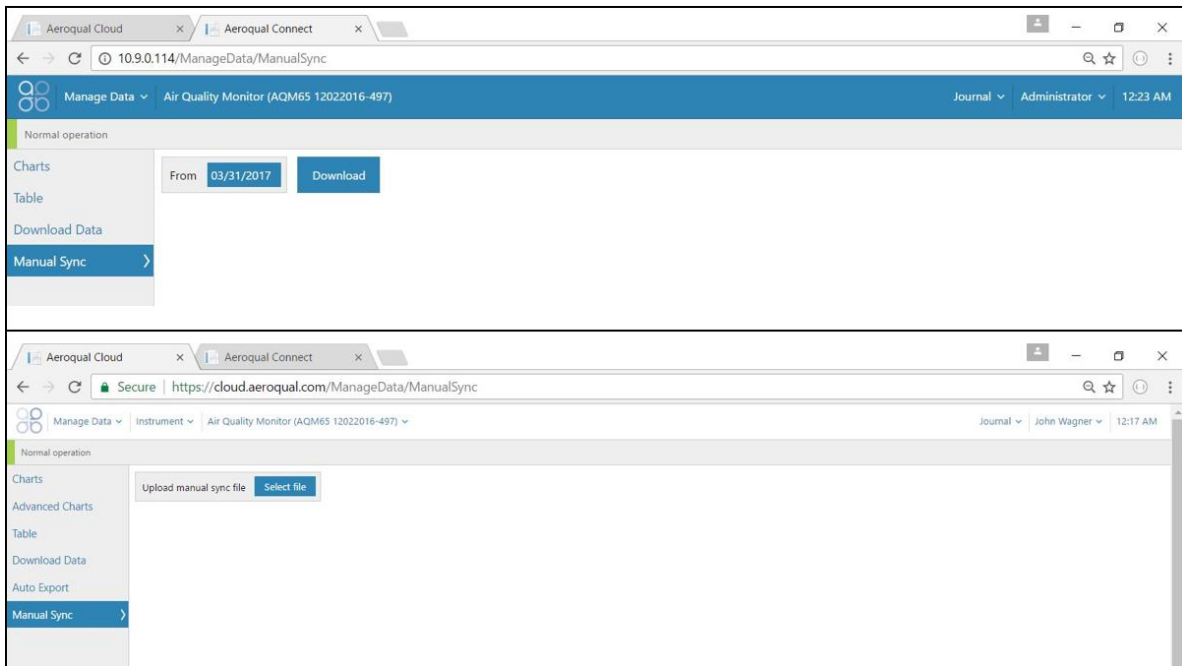

Figure 5-5 The manual sync tool in the Manage Data app allow all data from the Monitor to be manually uploaded to the Cloud if a local data connection is not available

5.2 Calibration and Service

Aeroqual Licence	User permission required
Connect / Cloud	User or higher

The Calibration and Service app has two functions, Service mode initiation, and changing gain and offset during calibration.

5.2.1 Service Mode button

When a service engineer visits the monitor to perform routine service such as filter changes or flow checks, this can cause the data to read very high or very low. During service activities the monitor can be put into Service Mode by clicking the service mode button. This will tag the data as “service data” which can later be filtered when daily or hourly averages are being calculated.

For further discussion on Service Mode see section 6.3.

5.2.2 Gain and offset adjustment

Gain and offset adjustments are made as part of the monitor gas calibration procedure.

5.3 Configure Instrument

Aeroqual Licence	User permission required
Connect	Engineer or higher

The Configure Instrument app provides useful information about the monitor, including:

- The list of configured licences.
- When data was last sent to the Aeroqual cloud database.
- The number of text alerts remaining.
- **NOTE:** These come from **cloud.aeroqual.com** not from the monitor.
- Setting measurement units to ppm, ppb, µgm-3 or mg-3, degrees °C or °F
- Set up text (SMS) and Email alerts.

- If a module is removed or added, then a software change is required. The software module configuration can be found in the Configure Instrument app.

5.4 Diagnostics and Advanced

Aeroqual Licence	User permission required
Connect	Engineer or higher

The Diagnostic and Advanced App provides access to monitor and individual module operating parameters and is used by Aeroqual technical support to troubleshoot and diagnose monitor condition. It provides real time information about the status of the modules and allows operational settings of the modules to be viewed or edited.

5.4.1 Diagnostics

Each module can be selected, and real time module operation parameters can be viewed.

5.4.2 Module settings

Each module has a set of operational parameters which control the module. These can be viewed or edited using the module settings dialogue.

IMPORTANT: These settings should not be changed without instruction from Aeroqual.

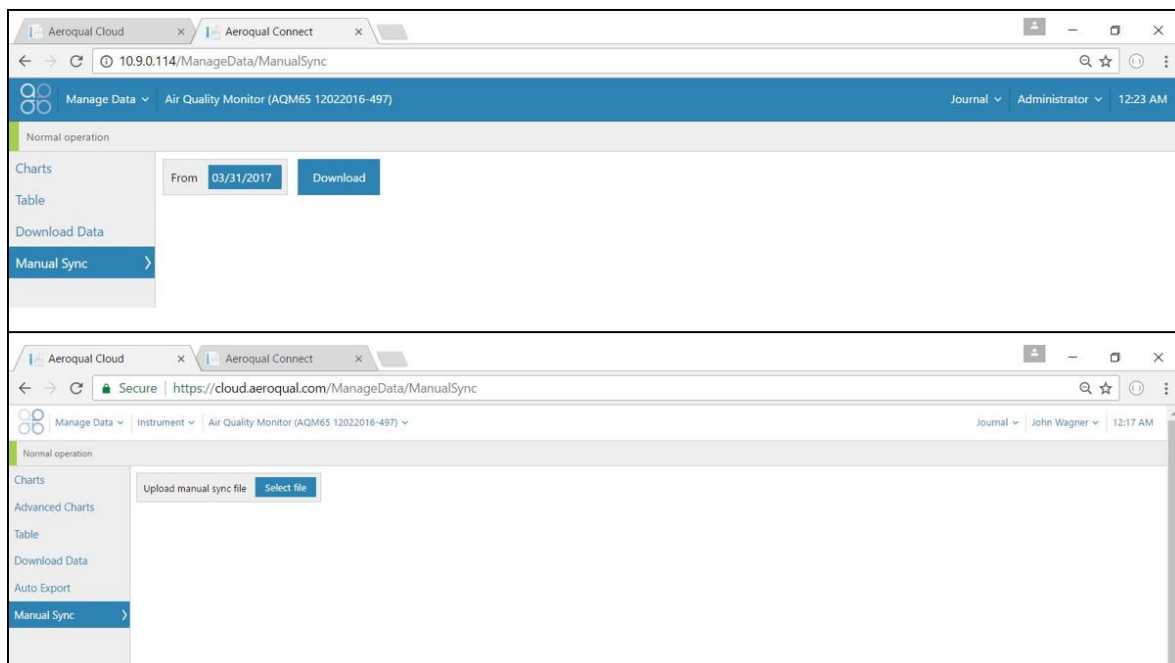

Figure 5-6 The Diagnostics and Advanced app displays real time monitor operational readings and settings which control how the modules are controlled.

5.4.3 Journal

Any changes to monitor settings are automatically recorded in the monitor journal with a date and time stamp and the username of the user who performed the change.

The journal entries are categorised to make it easier to search for specific entries. The categories are selected from the drop-down list.

Service activities such as filter replacements or flow checks are not automatically recorded by the software.

Engineers performing service or calibration can make specific user entries to describe their service activities.

NOTE: Keeping service records is a requirement under Aeroqual's factory warranty

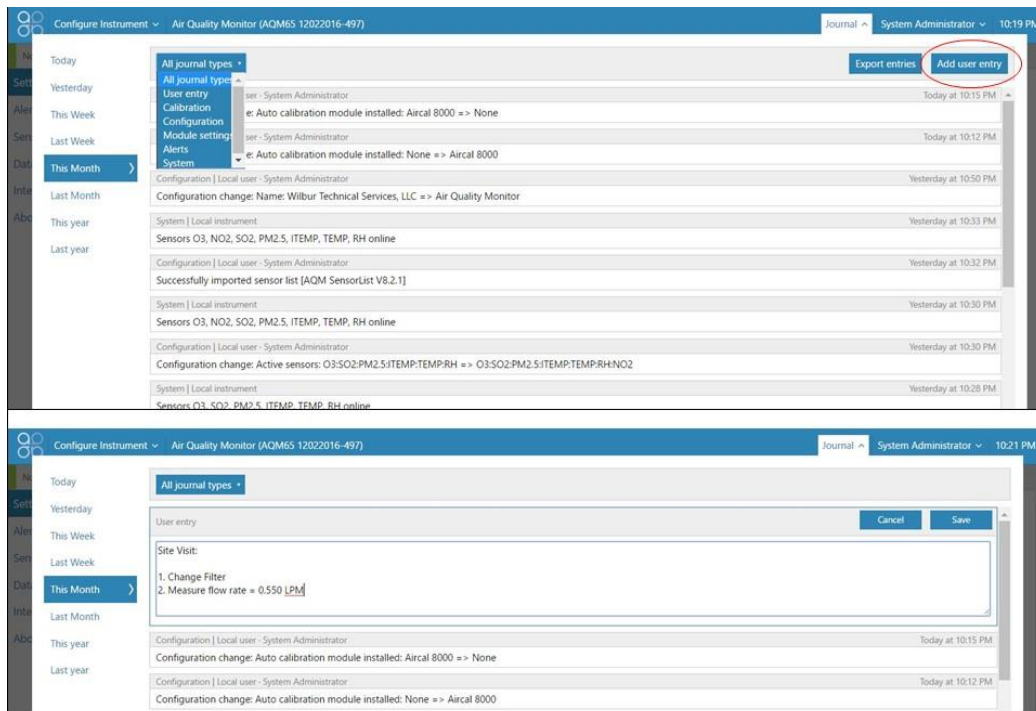

Figure 5-7 The Journal automatically logs software changes, it also allows manual user entries

5.5 Administration

The monitor ships from the Aeroqual factory with a default username and password:

Username: **administrator**

Password: **aqmadmin**

⚠ Security

These access credentials are published in multiple public documents and are only used to first connect to and configure the monitor. Aeroqual recommends that a new Administrator user is created with secure password and the default Administrator user is deleted which will make the monitor more secure.

There are three different user permissions which can be applied to individual users on the monitor. Each individual user of the monitor may be given an individual username and password to access the monitor. There is no limit to the number of users which can be created.

Access / Profile	User	Engineer	Administrator
Can view and download data.	✓	✓	✓
Can perform a calibration and change calibration settings	✓	✓	✓
Has full control over all monitor settings.		✓	✓
Can control access login and password for other users.			✓

Engineers cannot access the Administration App.

An administrator can access all the apps in Connect, and is the only user type who can access the Administration app. New users are created using the Administration App.

5.5.1 Monitor licences

The Connect software has some features which may need to be enabled through a licence, such as the application programming interface (API) feature and the FTP export feature. For information about Connect features which require a licence, contact the Aeroqual distributor in your local country for technical support.

5.5.2 Leasing instruments to Customer Organisations

- Instruments may be sold or leased to customer organisations
- Leased instruments stay with the customer organisation for a period decided by the Administrator of the parent organisation
- After a lease has ended, the instrument is moved back to the parent organisation by the Administrator of the parent organisation, there is no auto expiry of a lease.
- The data generated by the instrument during the period of the lease remains available to the customer organisation after the lease has ended.
- After the lease has ended, the instrument is then available to be leased to another customer
- The data from the previous lease is quarantined and is only available to the customer whom the instrument was leased to, subsequent customers can't see other customers data.
- The Distributor or the Customer, can (and should) erase all data from the local EPC, otherwise the data could be seen by future customers.

5.5.2.1 Procedure

When an Administrator moves an instrument under their customer's organisation, they will be asked whether they wish to "Move" or "Lease" the instrument.

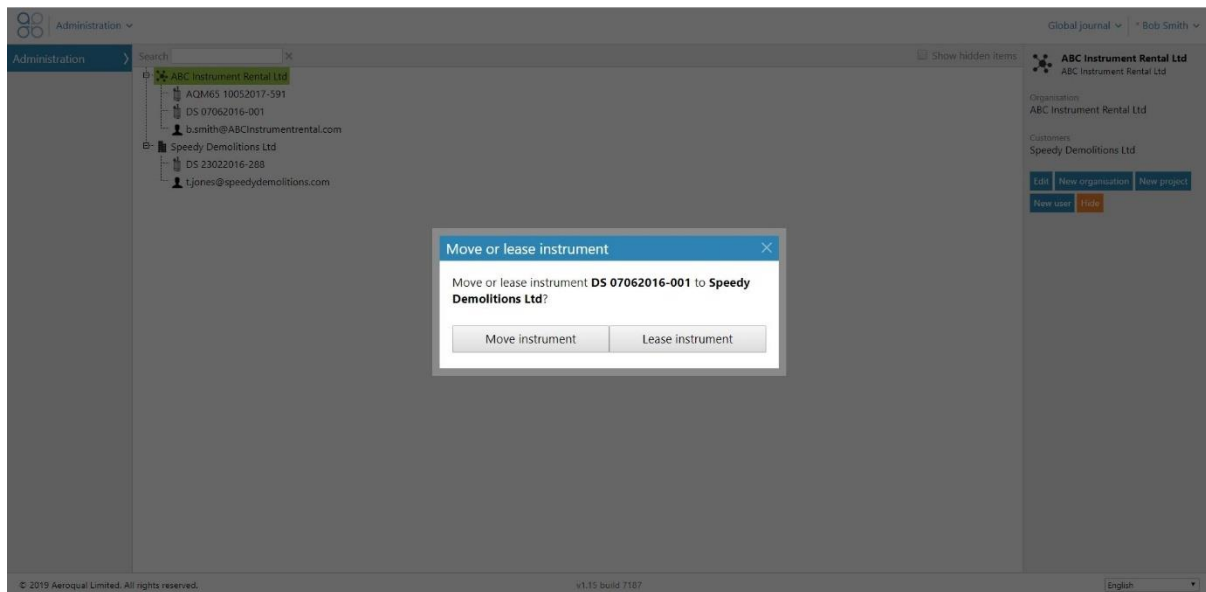

Figure 5-8 Options when moving an instrument under an organisation.

If "Move instrument" is selected the instrument is moved from the parent organisation to the customer organisation.

If "Lease instrument" is selected, the instrument is shown in two places: the instrument will still be shown under the parent organisation and will also be shown under the customer organisation.

The company which the instrument is leased to is shown next to the instrument in the parent organisation. The start date of the lease is shown next to the instrument in the customer organisation – see Figure 5-9.

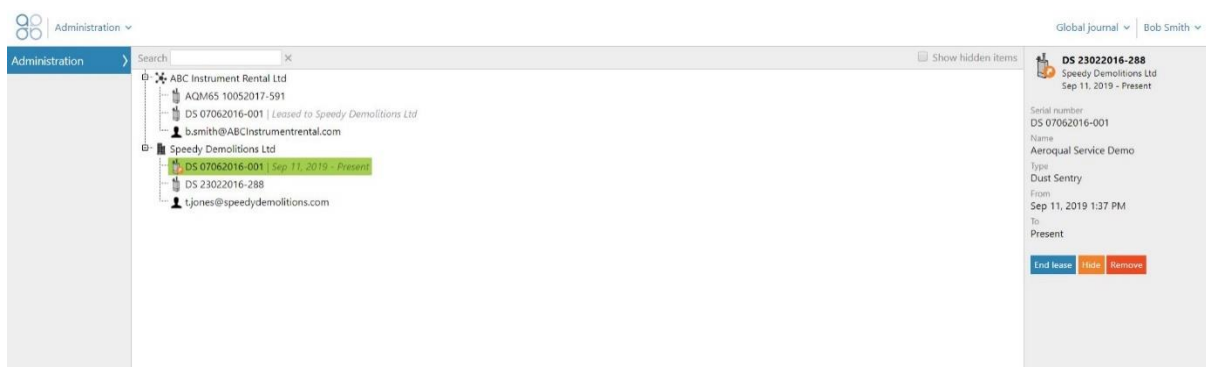

Figure 5-9 Instrument appears next to parent and leasing organisation.

After the lease is concluded the “End Lease” button is clicked by an Administrator of the parent organisation.

Under the parent organisation the “Leased to...” name of the customer organisation disappears from the instrument.

A symbol of the instrument remains under the customers organisation, with the start and end date of the lease shown next to the instrument– see Figure 5-10.



Figure 5-10 After lease ends a copy of the instrument remains under the customer with the lease dates.

The customer can still view their data by selecting the instrument however they have no control over instrument settings, or data outside of the Lease dates.

NOTE: If the customer wishes to download the data is important the instrument have a licence to allow that (Aeroqual Care) before the lease expired.

NOTE: The data is not automatically deleted or quarantined in CONNECT, it is the responsibility of either the parent organisation or the customer to delete the data from CONNECT – see Figure 5-11.

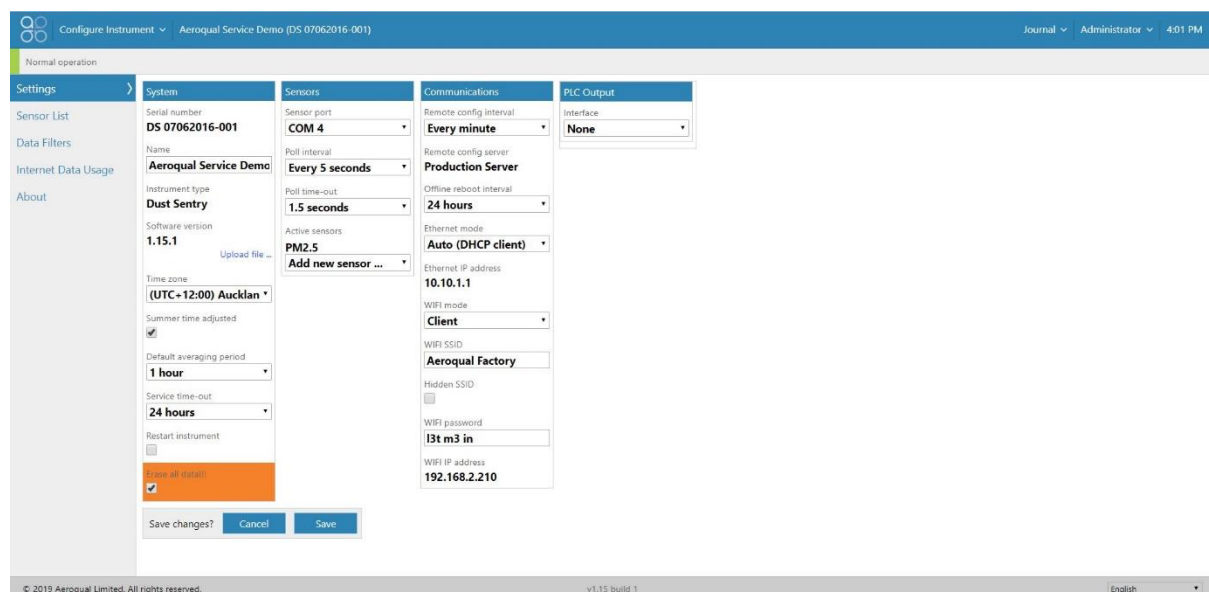

Figure 5-11 “Erase all data” is an option for the parent organization or the customer after a lease.

6 Service & Maintenance

Routine service and maintenance are required to ensure the monitor performs optimally.

The frequency of some service activities such as filter changes will depend upon local environmental conditions. Environments with higher particle concentrations, for example, will require more frequent filter changes.

Other service activities such as flow checks and pump replacements can be scheduled at routine intervals and other service activities such as module replacements are performed only when required.

Recommended service frequencies for each service activity are given in Section 6.1.

Further detail on each of the service activities can be found on the Aeroqual training website:

training.aeroqual.com (The training website requires a login, please email technical@aeroqual.com)

It is very important to keep service records. The Journal is used for this purpose. See Section 4.3 for a discussion of use of the Journal for service record keeping.



For some of the service activities described a video is also available on [YouTube](#). If a video is available, a web-link will be provided next to this symbol.



Safety requirements

- Replacement of any part should only be carried out by qualified personnel using only parts from the manufacturer
- Surfaces marked with a "Caution, Hot Surface" and an internationally recognised symbol may get hot and deliver burns
- If installed, the 82850 Particle Monitor is a Class 1 laser product and is not considered dangerous if used correctly. It should not be powered up with the cover removed.

6.1 Service frequency guidelines

The frequency of some of the service activities described above can depend upon environmental conditions and upon data quality objectives. Some service activities are required at fixed frequencies (**scheduled maintenance**), and some are performed only as required (**unscheduled maintenance**).

Service intervals will vary depending on site conditions. For instance, particulate matter levels will impact the frequency of filter changes – high PM levels = more frequent filter changes

It is important to change the filter when it gets dirty. Once the local site conditions are understood, a filter change schedule can be developed for that site.

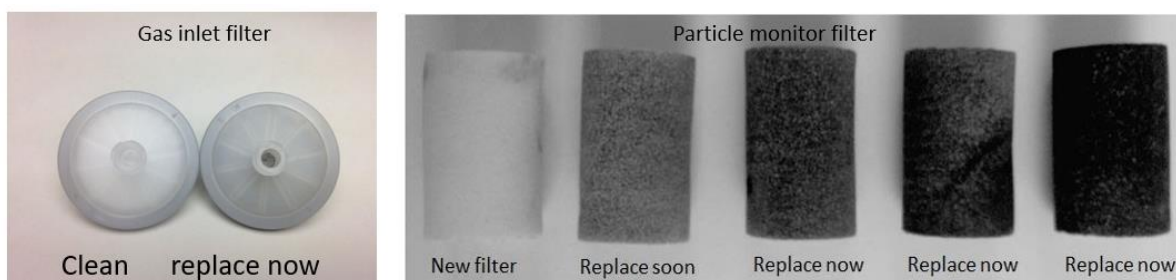

Figure 6-1 Filters should be changed before they get too dirty. The frequency of filter changes will depend upon local site conditions.

Data quality objectives will also influence the service frequencies for some operations. In monitoring situations where data quality objectives are high, for example where monitoring is performed for compliance or where a high amount of scrutiny will be placed on the data, service frequencies may be higher.

It is recommended that the monitor engineer, over time, develops an appropriate servicing schedule for a site.

6.2 Flow meters and flow measurement

Accurate and precise flow rate measurement is critical for monitor service and calibration. Flow rates can be measured and reported in several different ways. It is important to understand the terminology and equipment associated with flow rate measurement.

6.2.1 Flow meters for gas flow measurement

For gas flow measurements, Aeroqual recommends either the Bios Defender DryCal or the TSI 4040 (AQS R8 HS) flow meter. These can both be used to measure gas flow and Particle Monitor flow.



Figure 6-2 Bios Dry Cal and AQS R8 HS high specification flow meters.

6.2.2 Flow meter for PM flow measurements

For PM flow rate measurements, a 0.2 - 2.5 L/min rotameter is suitable, or the flow meters noted above. A rotameter is included in the Dust Sentry service kit (DS R20), but not the AQS service kit (AQS R20). It is also available separately (DS R8).



Figure 6-3 DS R8, 0.2 - 2.5 L/min rotameter for PM flow measurements.

6.3 Manual Service Mode

Performing service work on the monitor such as changing filters or measuring flow rates can cause the gas or particle readings to fluctuate. It is important to exclude these data from air quality reports. The monitor can be put in to “Manual Service Mode” by pushing the start button in the Calibration and Service app. This will cause the data to be labelled as “service”, normally the data is labelled as ‘sample’. This is illustrated in Figure 6-4 and allows a data analyst to easily filter out service data when performing quality control, calculating hourly or daily averages or writing air quality reports.

The screenshot shows the 'Calibration and Service' app interface. The 'Manual service mode' section has a green 'Start' button circled in red. Below it are 'Calibration parameters' and 'Real time measurements' tables. To the right, a Microsoft Excel spreadsheet shows a data table with columns for Time, CO2 (ppm), H2S (ppm), PID (ppm), PM2.5 (µg/m³), TEMP (°C), RH (%), and Inlet. The 'Inlet' column contains labels like 'Sample' and 'Service', with 'Service' labels circled in red to show the effect of entering service mode.

Time	CO2 (ppm)	H2S (ppm)	PID (ppm)	PM2.5 (µg/m³)	TEMP (°C)	RH (%)	Inlet
13/04/2017 12:10	381	0	0.181	26.8	21.73	69	Sample
13/04/2017 12:11	391	0	0.181	26.84	21.74	68.9	Sample
13/04/2017 12:12	397	0	0.18	27.3	21.74	69.2	Sample
13/04/2017 12:13	396	0	0.18	26.56	21.77	69.3	Sample
13/04/2017 12:14	433	0	0.179	26.13	21.84	69.2	Sample
13/04/2017 12:15	413	0	0.209	26.17	21.9	68.8	Service
13/04/2017 12:16	408	0	0.238	26.73	21.95	68.7	Service
13/04/2017 12:17	401	0	0.221	27.36	21.98	68.5	Service
13/04/2017 12:18	394	0	0.188	28.59	21.97	68.3	Service
13/04/2017 12:19	545	0	0.179	27.45	21.94	68.6	Service

Figure 6-4 The monitor can be put into Service Mode by clicking the button in the Calibration and Service app. This will label the data as "Service" in the inlet column so the data can be filtered.

6.4 Journal

All service activities should be documented. The Journal is accessed by clicking the Journal button next to the username at the top right of the screen, then selecting user entry.



Figure 6-5 All service activities can be recorded in the Journal manually.

6.5 Maintenance procedures

The following section describes all the common service activities required to ensure good operation of the monitor.

Some of the service activities need to be performed regularly such as filter changes and flow checks, and other service activities are performed only as required. A summary of expected service activities and how often they should be performed is described in Section 6.7.

For each service activity, the tools required are listed and references to additional information on the training website or video website is also given if available.

NOTE: Whenever these service activities are performed it is important to record the activity in the Journal using a manual user entry. See Section 6.4

6.5.1 Tools required for regular service and maintenance

Service and maintenance of the monitor requires basic tools such as Phillips head screwdriver and adjustable spanner, and multimeter for checking electrical connections.

The Dust Sentry or AQS monitor service kits (R20) are recommended for maintenance. A description of the components of the service kits can be found on the main page of the training website www.training.aeroqual.com.



6.5.2 Recommended tools for regular servicing and maintenance

- Large and small Phillips head screwdriver and large and small flat head screwdriver
- Gas flow meter AQS R8 HS – Ordered separately, only required for AQS (see section 6.1 for a discussion of requirements for flow meters)
- Rotameter for PM flow DS R8 (included in the Dust Sentry service kit DS R20)
- Vacuum gauge R23 (Included in both Dust Sentry and AQS R20 Service Kits, also available separately)
- Electrical multi meter (Only required for troubleshooting)
- Adjustable spanner

6.5.3 Replace gas sample inlet filter (AQS only)

The gas inlet filter is held inside the enclosure at the top left. This must be changed to ensure accurate readings. The filter is disposable and can be thrown away.

The filter should be changed when it becomes dirty as shown in Figure 6-6. The frequency of filter changes depends upon local environmental conditions.

	Tools required	None
	Parts required	AQS R12 (bag of 25 filters)
	Service interval	Recommended Monthly (depends on local conditions) See Section 6.1 for further discussion on filter change frequencies.

Do not turn off the monitor, this procedure can be done with the monitor turned on.





NOTE: It is very important to check the monitor inlet flow rate is correct after changing the filter to ensure there are no leaks



Figure 6-6 The particle filter on the gas inlet can be easily replaced, it should be replaced when it gets dirty as shown in the image on the right (a new filter is shown on the left, dirty filter on the right).

6.5.4 Measure and adjust monitor inlet flowrate and module flow rate

Maintaining a consistent flow rate is very important for ensuring accurate measurements. Leaks, or an aging pump may lead to reduced flow. Regularly measuring the flow rate will ensure any changes to flow rate are identified as soon as possible.

	Tools required	AQS R8 HS, Inlet flow adaptor (comes with monitor accessories box) Small Philips head screwdriver
	Parts required	None
	Service interval	Recommended Monthly .
	Online reference	training.aeroqual.com: Dust Monitor technical Training Section 4.2
	Online video	YouTube Channel: Aeroqual Service and Maintenance playlist

6.5.4.1 Measure main gas inlet flow rate

- Remove the white inlet fitting containing the mesh filter and attach the inlet flow adaptor.
- Attach a high-quality flow meter such as the AQS R8 HS or Bios Dry Cal. See section 6.1.
- Record the inlet flow rate in the Journal by making a manual user entry.

The gas inlet rate is controlled, for a description of the expected flow rate for the module see Table 12-1.

When the monitor is new, the inlet flow rate is recorded in the monitor logbook which is provided from the Aeroqual factory. The measured flow rate should be equal to the previously measured flow rate which is recorded in the monitor journal.



Figure 6-7 To measure the flow rate, remove the Kynar inlet filter and attach the inlet flow adaptor.

6.5.4.2 Measure the flow rate of the module

The module flow rate is measured using a high-quality flow meter such as the AQS R8 HS or the Bios Dry Cal. See Section 6.1

- Attach the flow meter to the inlet port (white ring) of the gas module
- Reconnect the inlet fitting after measuring the gas module
- Record the flow rate of the module in the Journal by making a manual user entry

6.5.4.3 Adjust the PM inlet flow rate

If the PM inlet flow rate is found to be lower than expected, it could be because one of the modules has a leak or is blocked.

To check this, perform a flow check on the individual modules as described in Section 6.5.11

If one of the modules is found to be blocked or has a leak, then this will need to be corrected.

If all the modules showed reduced flow, then it is likely that the gas flow pump is aging.

The flow adjustment valve can be used to provide more flow to the module inlets and return the flow rate to the expected flow rate.

Attach a flow meter to the inlet and begin measuring the inlet flow. Adjust pump flow adjustment valve until the monitor inlet flow rate has returned to the expected flowrate. The valve is shown in Figure 6-8.



Figure 6-8 The flow adaptor valve is used to adjust the monitor inlet flow to the correct value.





If the correct flow rate cannot be set, then it may be required to replace the gas sample pump. The pump is part number **AQS R10**. The pump can easily be removed from the bracket for replacement.

IMPORTANT Use fresh Tygon Tube (CS Tube 10) when re-connecting the tube back on the pump. This is because the barbs on the pump stretch the tube.

The online training website contains details on how to replace the gas sample pump.

6.5.5 Replace filter on Particle Monitor or Particle Profiler

The Particle Monitor and Particle Profiler have filters which need to be replaced. Disconnect the pump module power when replacing the filter, see Figure 6-15. and Figure 6-16.

	Tools required	Large flathead screwdriver
	Parts required	DS R31 (Particle Monitor) DS R32 Particle Profiler
	Service Interval	Recommended Monthly (depends on local conditions) See Section 6.1 for further discussion on filter change frequencies.
	Online reference	training.aeroqual.com: Dust Monitor technical Training, section 5.1
	Online video	YouTube Channel: Aeroqual Service and Maintenance playlist

The filters for the Particle Monitor are located inside the optical module. Use a large flat head screwdriver to unscrew the filter housing on the front panel of the optical module.

The filters for the Particle Profiler are in a filter casing outside the optical module and within the Particle Profiler Pump Module.

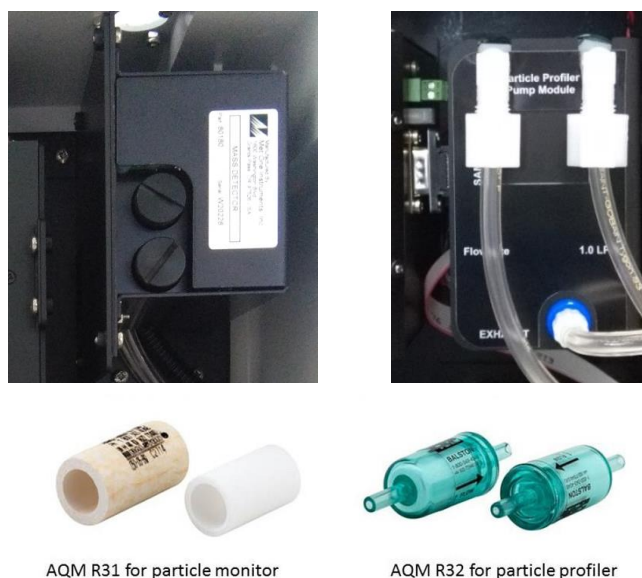

Figure 6-9 The Particle Monitor (shown on the left) requires AQS R31 and the Particle Profiler (shown on the right) requires AQS R32

Section 6.1 discusses frequencies for changing the filters on the Particle Monitor and Particle Profiler. However, if the filters look visibly blackened, they should be replaced, regardless of the time elapsed.

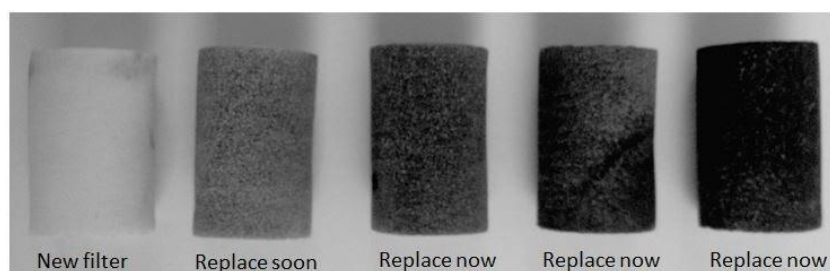







Figure 6-10 The AQS R31 sample filter should be replaced once the filter begins to blacken

6.5.6 Flow check and flow adjustment of the Particle Monitor and Particle Profiler

It is important to maintain the correct flow rate through the Particle Monitor or Particle Profiler. The flow rate of the Particle Monitor and Particle Profiler are different.

NOTE: The flow rate of the Particle Monitor is 2.0 ± 0.05 LPM

The flow rate of the Particle Profiler is 1.0 ± 0.05 LPM

	Tools required	Small Philips head screwdriver, AQS R56 and DS R8 or AQS R8 HS
	Parts required	None
	Service Interval	Recommended Monthly . (See Section 6.1)
	Online reference	training.aeroqual.com: Dust Monitor technical Training Section 4.1
	Online video	YouTube Channel: Aeroqual Service and Maintenance playlist

The AQS R56 includes a flow adaptor which is fitted on the inlet, for the Particle Monitor it is fitted above the cyclone as shown in Figure 6-11.

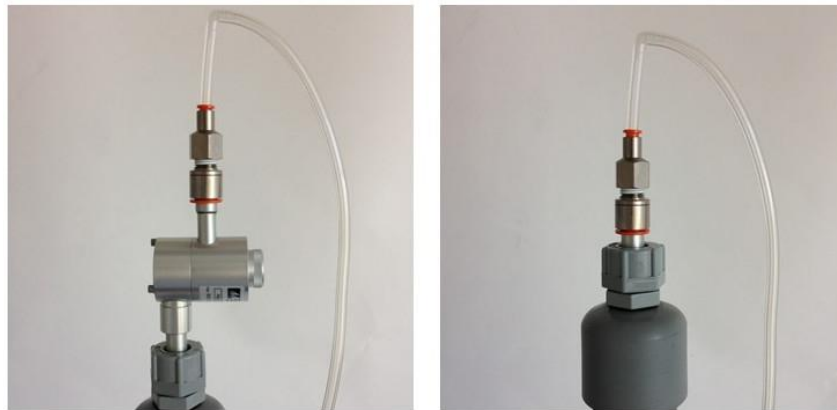

Figure 6-11 When checking the flow rate of the Particle Monitor (left) place the flow measurement adaptor above the cyclone. The position of the flow adaptor when measuring the Particle Profiler is shown on the right.

6.5.6.1 Using the buffer chamber when checking the flow of the Particle Profiler

When measuring (or adjusting) the flow rate of the Particle Profiler it is important to use the buffer chamber to ensure accurate measurement. The buffer chamber is part of the AQS R56 Zero Filter and Flow assembly. It is also part of the R20 Service kits. Figure 6-12 shows the buffer chamber installed between the flow meter and the profiler inlet.

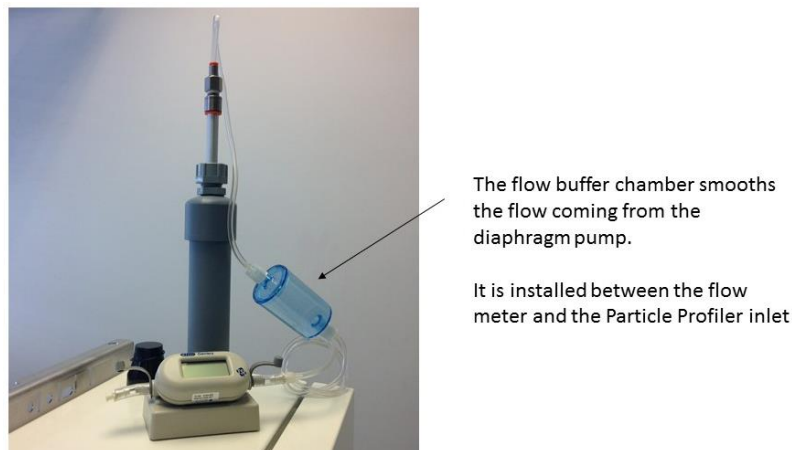

Figure 6-12 When measuring the flow on the Particle Profiler it is important to use the flow buffer chamber

6.5.6.2 Flow adjustment of Particle Monitor

The flow rate of the Particle Monitor must be 2.0 LPM \pm 0.05 (between 1.95 and 2.05 LPM)

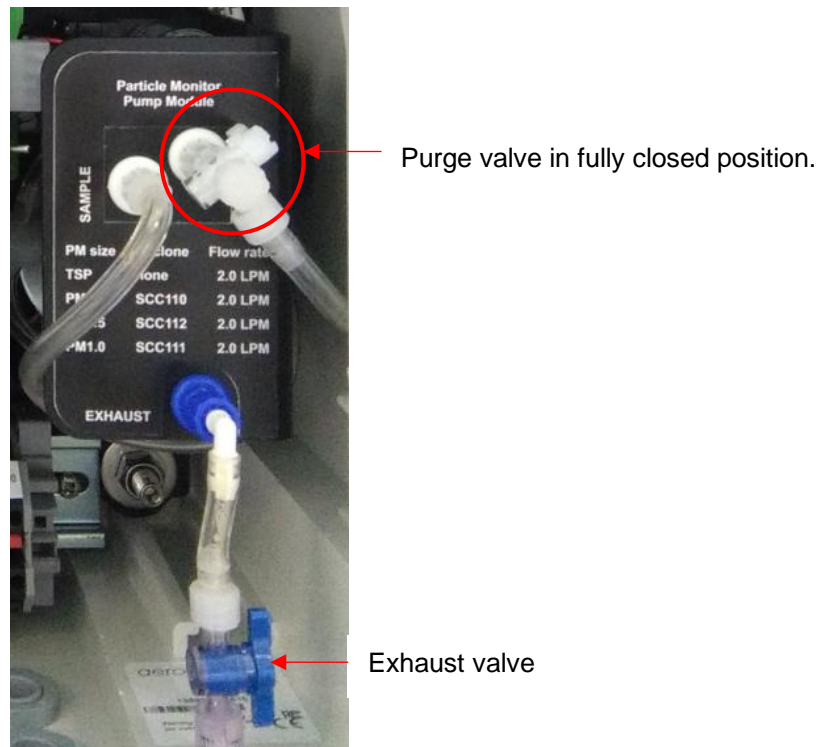

Figure 6-13 The flow rate of the Particle Monitor is set by adjusting the purge and exhaust valves

The flow rate of the Particle Monitor must be 2.0 LPM \pm 0.05 (between 1.95 and 2.05 LPM)

- Fully close the purge valve by pushing the valve handle towards the module
- Adjust the exhaust valve until the flow reads 2.2 LPM
- Adjust the purge valve until the flow reads 2.0 LPM \pm 0.05

The final adjustment can be a little tricky, turn the purge valve slowly. If it is not possible to reach 2.2 LPM at step 2 then there may be a leak, or the pump might need to be replaced.

6.5.6.3 Flow adjustment of Particle Profiler

NOTE: It is important to use the buffer chamber when measuring or adjusting the flow rate of the Particle Profiler. Section 6.5.6.1

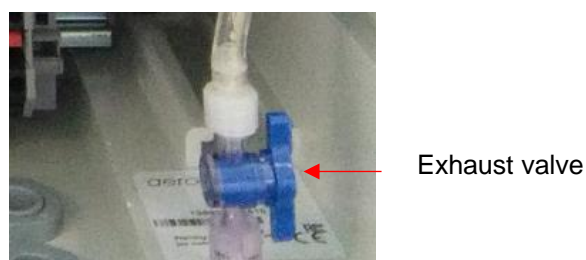







Figure 6-14 The flow rate of the Particle Profiler is set by adjusting the flow adjustment valve

The flow rate of the Particle Profiler is adjusted to 1.0 LPM \pm 0.05 LPM using the flow adjustment valve as shown in Figure 6-14.

6.5.7 Leak check Particle Monitor and Particle Profiler

If the aluminium inlet is not correctly installed (see Section 2.4.1) or if the tubing is split, then the PM can have a leak. The vacuum gauge (AQS R23) is used to check for leaks in the Particle Monitor system and should be performed as part of regular service.

	Tools required	AQS R23
	Parts required	None
	Service Interval	Recommended Every three months (See Section 6.1)
	Online reference	training.aeroqual.com: Dust Monitor technical Training Section 4.2
	Online video	None

6.5.7.1 Leak check a Particle Monitor

1. Remove the TSP head and install the R23 vacuum gauge above the sharp cut cyclone
2. Fully close the purge valve and fully open the exhaust valve
3. The vacuum gauge should reach at least -60 kPa
4. Then remove power (pull out black and red cable) to the electronics module to turn off the pump.
5. Count how long it takes for the pressure to change by 10 kPa.



Figure 6-15 Fit the vacuum gauge, adjust the valves. Then stop the pump by removing power from the module, observe the change in pressure. If the leak rate is greater than 10 kPa in 10 seconds, then there may be a leak in the system. Check all the tube connections.

NOTE: The pressure change (leak rate) should be no more than 10 kPa in 10 seconds.

6.5.7.2 Leak check a Particle Profiler

1. Fully open the sample valve
2. The next step is to block the purge flow:
 - a. For older Particle Profiler modules, disconnect the purge line and cap the purge line and purge ports with luer caps as shown in Figure 6-16
 - b. For current Particle Profiler modules, pinch the tube as shown in Figure 6-17
3. Remove the TSP inlet and place the vacuum gauge on the inlet
4. Wait for the vacuum gauge to stabilise
5. Remove black and red power cable from electronics box

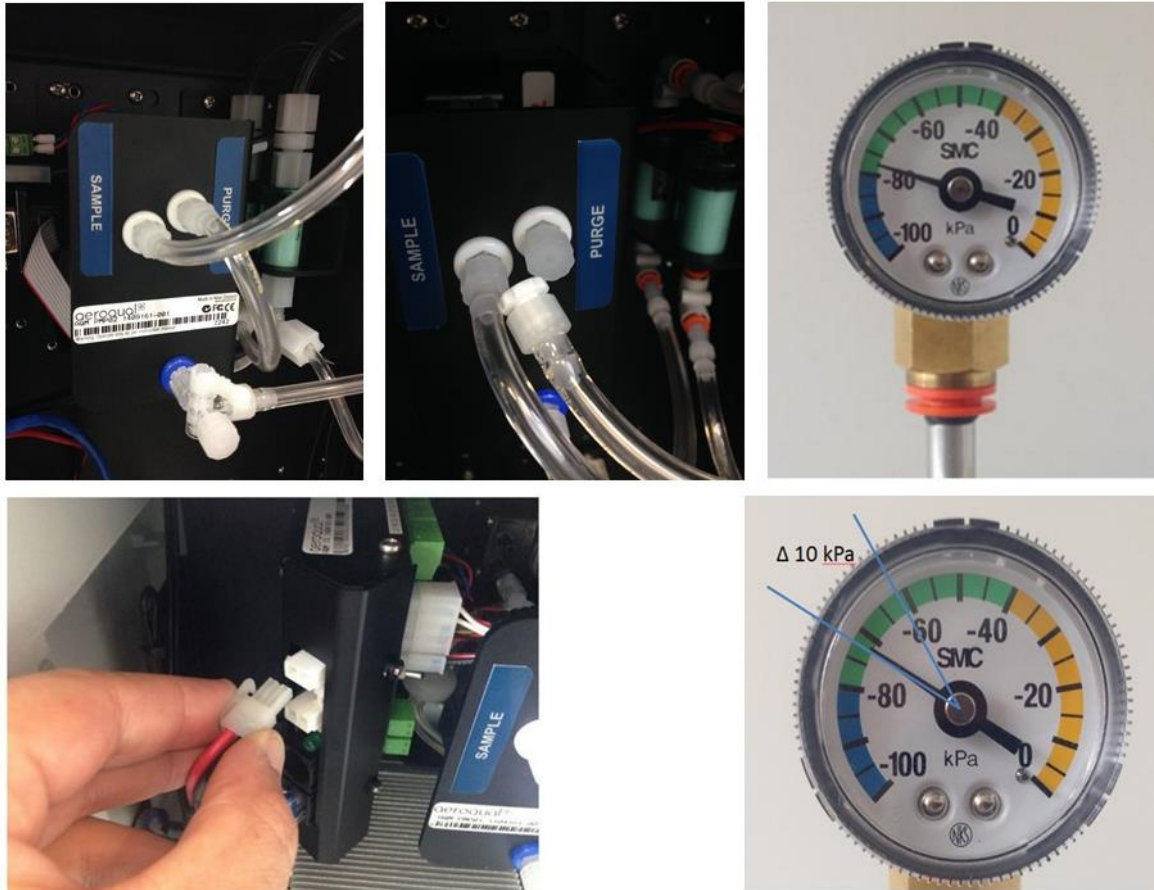







Figure 6-16 Original Particle Profiler Cap the purge and exhaust lines. Place the vacuum gauge on the inlet. Disconnect the power, observe the change in pressure.



Figure 6-17 Pinch the tube with the newer Particle Profiler pump module

NOTE: The pressure change (leak rate) should be no more than 10 kPa in 10 seconds

6.5.8 Zero calibration check and flow check of Particle Module

	Tools required	R56, and DS R8 or AQS R8 HS
	Parts required	None
	Service interval	Recommended Monthly . (See Section 6.1)
	Online reference	training.aeroqual.com: Dust Monitor technical training Section 4.4
	Online video	YouTube Channel: Aeroqual Service and Maintenance playlist

6.5.8.1 Check zero baseline of Particle Monitor

The Particle Monitor (nephelometer) has an automatic zero calibration function which runs every 12 hours, this procedure automatically changes the zero offset of the Particle Monitor.

The zero response of the Particle Monitor can be checked by removing the TSP head and placing the R56 adaptor and zero filter assembly on the inlet above the cyclone as shown in Figure 6-18. The Particle Monitor should read between $\pm 3 \mu\text{g m}^{-3}$.

If the zero check shows negative numbers, there may be a problem with the auto zero cycle. See the troubleshooting section. Troubleshooting in Section.

Check that the gain and offset values for the Particle Monitor are set to sensible settings. The gain should be between about 0.6 and 4.0. The offset should be 0.000.

See Section 7.2 for a discussion on gain adjustment of the Particle Monitor.



Figure 6-18 The zero filter is fitted above the cyclone for a Particle Monitor (left) and directly on the inlet for a Particle Profiler (right)

6.5.8.2 Check the auto zero calibration flow rate of the Particle Monitor

The Particle Monitor executes an automatic zero calibration every 720 minutes (12 hours). The auto zero process resets a parameter in the module's settings. The value which is changed is the H0 parameter.

NOTE: *The particle profiler does not have this feature.*

The auto zero procedure on the Particle Monitor causes the baseline to be adjusted. Negative readings on the Particle Monitor are often a result of the auto zero cycle failing to work correctly.

The zero cycle works by switching off the sample pump and switching on a zero pump. The flow rate during the zero cycle is reversed and is a positive flow out through the inlet. The flow rate is approximately 0.2 to 0.6 LPM.

This flow rate does not need to be set to a specific value, but it is important that the flow rate is at least 0.2 LPM positive flow out from the inlet.

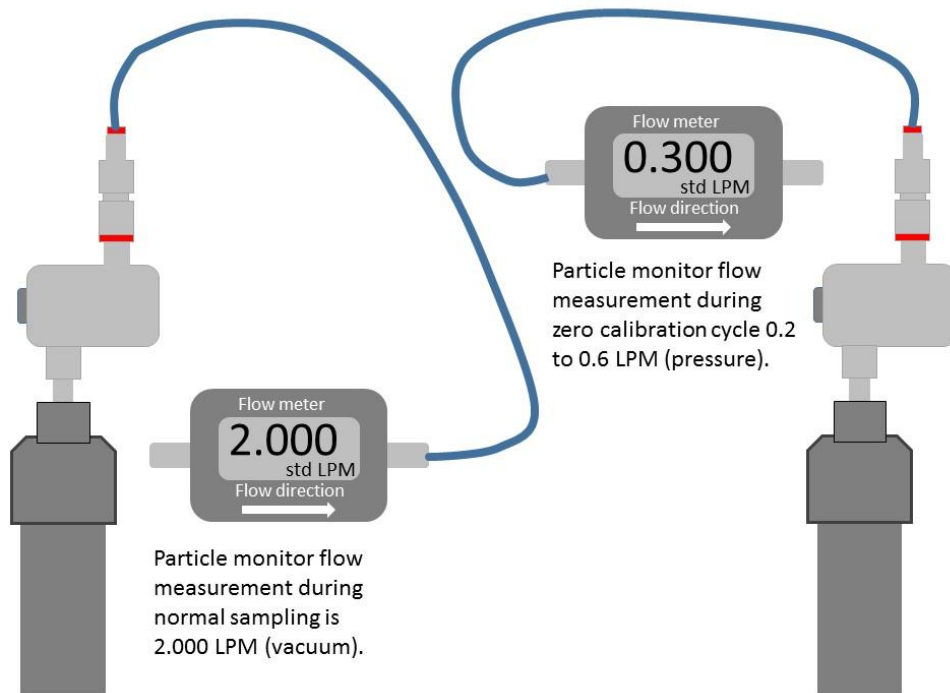

Figure 6-19 When measuring the sample flow of the Particle Monitor a vacuum is measured. When measuring the zero flow a positive pressure is measured.

The auto zero can be executed manually by temporarily changing one of the module settings. Once the auto zero cycle is complete the setting needs to be returned to the original setting.

- Go to the Diagnostic and Advanced app in Connect software.
- Select Module settings from the list on the left column
- Locate the Particle Monitor settings, these will be either PM10.0 or PM2.5
- Locate the TIMA parameter (it should be 720).
- Change this value to 1 by clicking in the cell and typing 1, then save the setting change.

This will cause the auto zero to start. The flow will change from 2.000 LPM negative flow into the inlet to approximately 0.2 to 0.6 positive flow out from the inlet.

You will need to change the port on the flow meter to measure this flow as shown in Figure 6-18.





- If no flow is measured there may be an issue with the zero cycle or zero pump. See Appendix 1 for trouble shooting.
- Measure the positive flow coming out from the inlet and record this in the journal.

The zero cycle takes approximately 6 minutes to complete.

NOTE: Once the flow has been measured the TIMA parameter must be set back to 720.

6.5.9 Clean the Particle Monitor TSP inlet, particle trap and cyclone.

The Particle Monitor cyclone uses a small particle trap to remove larger particles. The trap needs to be emptied and cleaned for optimum operation of the Particle Monitor. If the particle trap overfills then the entire cyclone needs to be cleaned.

	Tools required	Can of compressed air, cloth
	Parts required	None
	Service interval	Recommended 6 Monthly . (See Section 6.1)
	Online reference	training.aeroqual.com: Dust Sentry technical Training Section 5.1
	Online video	YouTube Channel: Aeroqual Service and Maintenance playlist

The TSP head, particle trap and cyclone disassemble easily for cleaning.



Figure 6-20 The TSP head and cyclone can be disassembled for cleaning.

6.5.10 Replace pumps in pump module

The pumps in the Particle Monitor pump module and in the Particle Profiler pump module can easily be replaced.

The Particle Monitor contains a sample pump (AQS R10) and a purge pump (AQS R34). The Particle Profiler only has a sample pump (AQS R10)

Typically, the pumps last between 12 and 18 months. However, the pumps should be replaced when the correct flow can no longer be maintained.

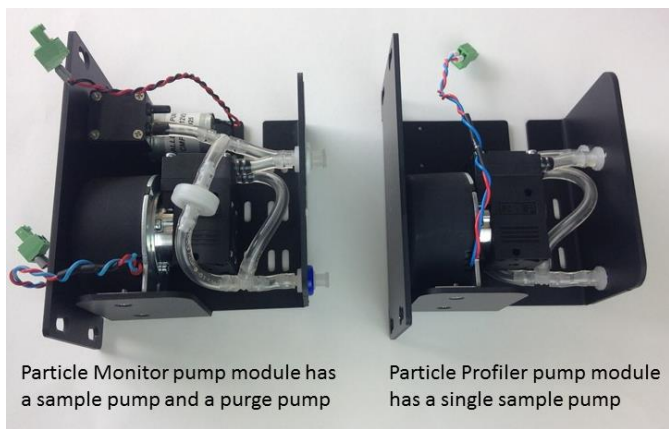







Figure 6-21 The Particle Monitor contains two pumps, the Particle Profiler has one pump.

6.5.11 Leak check gas module

If the correct flow rate cannot be achieved through a gas module, this may indicate a leak. An individual gas module can be checked for leaks by using a small diaphragm pump and a flow meter in the configuration shown in Figure 6-22

	Tools required	Diaphragm pump R10, flowmeter DS R8 or AQS R8 HS
	Parts required	None
	Service interval	Only as required. (See Section 6.1)
	Online reference	None
	Online video	None

A gas module should be leak tight.

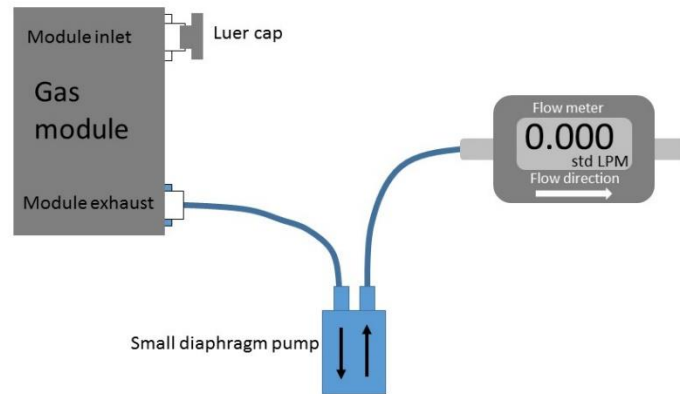





Figure 6-22 A gas module can be checked for leaks by using a diaphragm pump and R7 flow meter

NOTE: If the module is found to have a leak, contact the Aeroqual distributor in your local country for technical support.

6.5.12 Remove and replace a gas module

Replacing the module configuration can be done easily on site.

A change in the module can result in a change of inlet flow rate. It is important to measure the inlet flow rate after the module change and document this in the monitor journal.

	Tools required	Tube Cutter, Large Phillips head screwdriver, AQS R8 HS
	Parts required	Tubing: CS Tube10 CS Tube11, power cable, communication cable, 2x luer cap
	Service interval	As required

If a module is removed or added, then a software change is required. The software module configuration can be found in the Configure Instrument app. Sensor modules can be added or removed using this tool, shown in **Figure 6-23**.

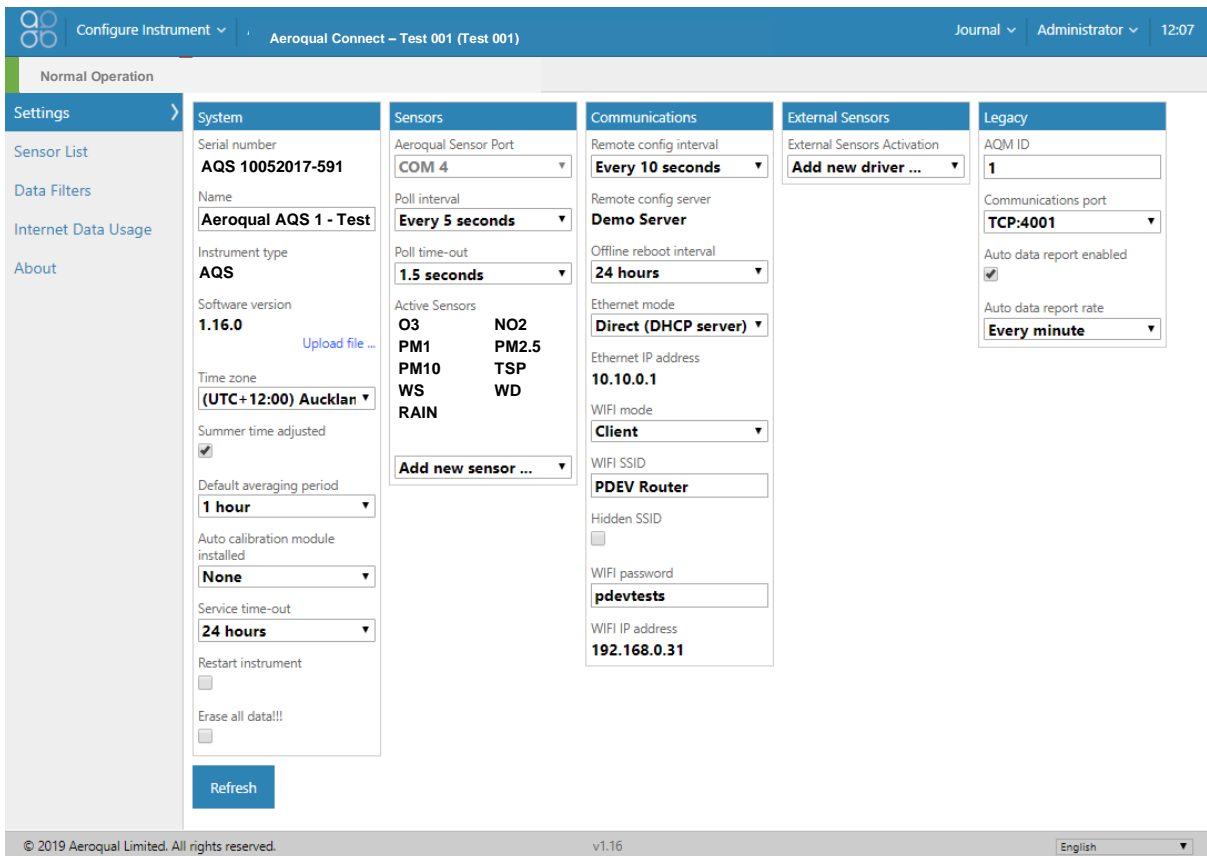

Figure 6-23 Change the module configuration in the software in the Configure Instrument app.

6.5.12.1 Replacing a module with another of the same type

This can be done with the monitor power left on. There is no software change required when removing a module.

- Disconnect the vacuum and sample lines
- Remove one blue communications cable and one red and black power cable
- Loosen the retaining screws and remove the module
- Replace the module with the new module
- Reconnect the blue communication cable and black and red power cable to ensure all modules have power and communications.

IMPORTANT Ensure the polarity of the red and black cable is the correct orientation.

- Cap off the vacuum and sample lines using a luer cap
- Remove the module from the sensor list in the software (Configure Instrument app)
- Measure the total inlet flow rate and document this in the journal

6.5.12.2 Adding a new module

This can be done with the monitor power left on. There is a software change required when adding a module.

You will need one blue communications cable and one black and red power cable.

You need 4 x 10mm M4 screws.

It may be necessary to cut into the sample and exhaust lines in order to add additional gas fittings. For this you will need a tube cutter, **do not use scissors**. You will also need tee fittings and luer fitting, and tubing. It may be possible to connect a new module directly to manifold on the left side of the enclosure.

It is important to use the PFA (CS Tube 11) for the gas sampling and Tygon (CS Tube 10) for the exhaust (See Section 12.1.2 for a description of the sample and exhaust manifold).

It is important to use the large barb tee for the exhaust tubing and the small barb tee for the sample tubing.

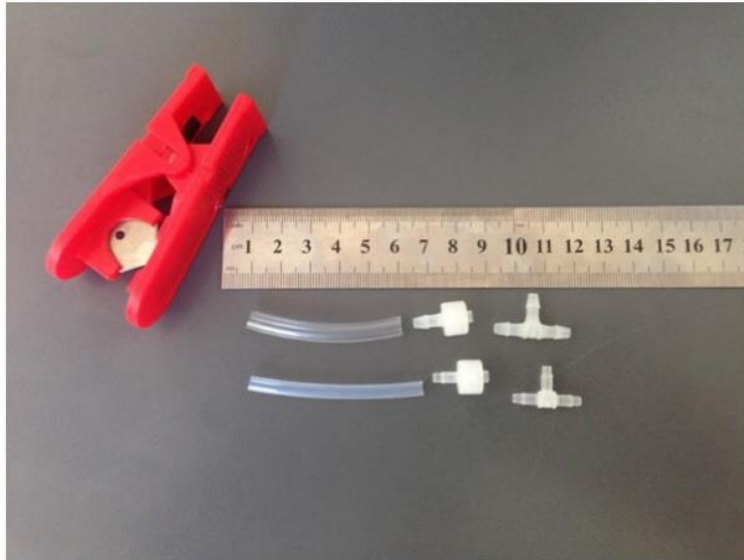

Figure 6-24 Adding a new module requires adding additional sample and exhaust lines.

6.6 Factory calibration of Particle Monitor

Dust and other debris can settle upon the internal optics of the optical engine which can lead to inaccurate readings. The laser and detector may also need to be replaced.

The Particle Monitor optical module (nephelometer) requires a factory service and calibration every two years.

For information about factory service and calibration of the Particle Monitor, please check with the Aeroqual distributor nearest to you.

6.7 Scheduled maintenance

The service frequencies should be considered conservative. Monitor operators are encouraged to develop a service schedule suitable for their local conditions and data quality objectives.

Service activity	Section	Service frequencies
Gas inlet filter change	6.5.3	4-12 weeks Initially 4 weeks . Later this can be modified to suit local conditions and data quality objectives
PM inlet filter change	6.5.5	4-12 weeks Initially 4 weeks . Later this can be modified to suit local conditions and data quality objectives
Gas inlet flow check	6.5.4.1	4-12 weeks Initially 4 weeks . Later this can be modified to suit local conditions and data quality objectives
PM inlet flow check	6.5.6	4-12 weeks Initially 4 weeks . Later this can be modified to suit local conditions and data quality objectives
Gas inlet flow adjustment	6.5.4.3	Adjust as required following gas inlet flow check
PM inlet flow adjustment	6.5.6	Adjust as required following PM inlet flow check
PM leak check	6.5.7	Every 3 months (Quarterly)
PM zero calibration check	6.5.8	Every 3 months (Quarterly)
PM zero calibration flow check	6.5.8.1	Every 3 months (Quarterly)
PM inlet cleaning	6.5.9	Every 3 months (Quarterly)
Change gas flow pump	6.5.10	Every 12 to 18 months or if flow rate cannot be set correctly
Change Particle Monitor flow pumps	6.5.10	Every 12 to 18 months or if flow rate cannot be set correctly
Factory calibration of Particle Monitor	6.6	Every 24 months (2 years)
Factory calibration of Particle Profiler	6.6	Every 12 months (1 year)
Gas module calibration	5.1	See section 7.1
Unscheduled maintenance		
Service activity	Section	Service frequencies
Measure flow rate of gas modules	6.5.4.2	As required following gas inlet flow check
Leak check a gas module	6.5.11	As required following module flow check
Add, remove, replace gas module	6.5.12	As required

Table 6-1 Service frequency guidelines for various service activities

7 Calibration

NOTE: A calibration record is supplied with the monitor, additional copies can be requested by contacting technical@aeroqual.com

7.1 Gas module calibration

There are three types of calibration of the gas module:

1. **Factory calibration pre-shipment.** All gas modules are calibrated and must meet rigorous performance standards before being shipped. This is captured by the factory calibration certificate. Experience shows that Aeroqual's factory calibration transfers well to the field, meaning that field calibration is not required during initial set up.
2. **Field calibration.** The monitor is designed so that the gas module can be calibrated in the monitor in the field. The field calibration set up and process is very similar to calibration of US / EU EPA approved 'reference' analyzers.
 - Field calibration is only recommended when:
 - a) the gas module is clearly operating out of specification and the appropriate troubleshooting steps have been taken, or;
 - b) periodical validation of the data is required (recommended for advanced users only).
3. **Factory calibration post-shipment.** At any time, the gas module can be removed from the monitor and returned to the factory or one of our authorised service providers for factory calibration. If the gas module has not been field calibrated, then it is recommended to have the gas module factory calibrated every 12 months

The following instructions relate to field calibration only.

Field calibration is an activity that requires attention to detail and accuracy. You should read this entire calibration section and understand it before starting, even if you are an experienced practitioner.

- The monitor is calibrated using a two-point calibration procedure, first by delivering zero air to the monitor inlet and adjusting the offset, and then delivering span gas to the monitor inlet and adjusting the gain.
- Aeroqual provides all the equipment required to perform field calibration. Aeroqual offers a portable calibrator called the AirCal 1000.
- Offset and gain adjustments are performed using the software tools provided by Aeroqual Connect or Aeroqual Cloud.
- If the AirCal 1000 is being used, there is a separate PC desktop software application which can be downloaded from the website.

Some important considerations for field calibration:

- Gas module calibration is achieved using certified calibration gas and a gas dilution calibrator.
- For ozone, an ozone generator, (ozone calibrator) must be used, Aeroqual recommends the 2B Tech Ozone generator part number AQM O3CAL.
- Aeroqual does not recommend calibration when first commissioning a new monitor. We recommend first calibrating 1-3 months after commissioning.
- The quality of the calibration gas makes a big difference to success of a calibration, only purchase calibration gas from a reputable calibration gas supplier.
- The monitor must be in a stable condition before calibration can be attempted. The monitor must have been running for at least 6 hours before calibration, ideally 24 hours.
- The zero calibration step takes approximately 30 minutes total across all modules. The span calibration takes approximately 30 minutes per-module. Therefore, a monitor with 2 gas modules will take 30 + (2 *30) minutes (approximately 1.5 hours) to calibrate.
- Record keeping is a crucial part of calibration, the journal feature in Connect and Cloud is where calibration record keeping is performed.

Calibration is discussed in detail in the online training. Several supporting videos are also available.

	Online reference	training.aeroqual.com Dust Sentry Technical Training Section 6
	Online video	YouTube Channel: Aeroqual Service and Maintenance playlist

7.1.1 Equipment required

Calibration of the gas modules inside the monitor requires specialist equipment which Aeroqual can provide.

Gas Module	Equipment	Comment
O ₃	O3Cal	Tubing and gas fittings are <u>not supplied</u> with the O3Cal. The calibration tubing and fittings can be ordered separately using part number: AQM CALKIT.
NO ₂	Aeroqual AirCal 1000	Tubing and gas fittings are supplied with the AirCal 1000.
PID	Aeroqual AirCal 1000	

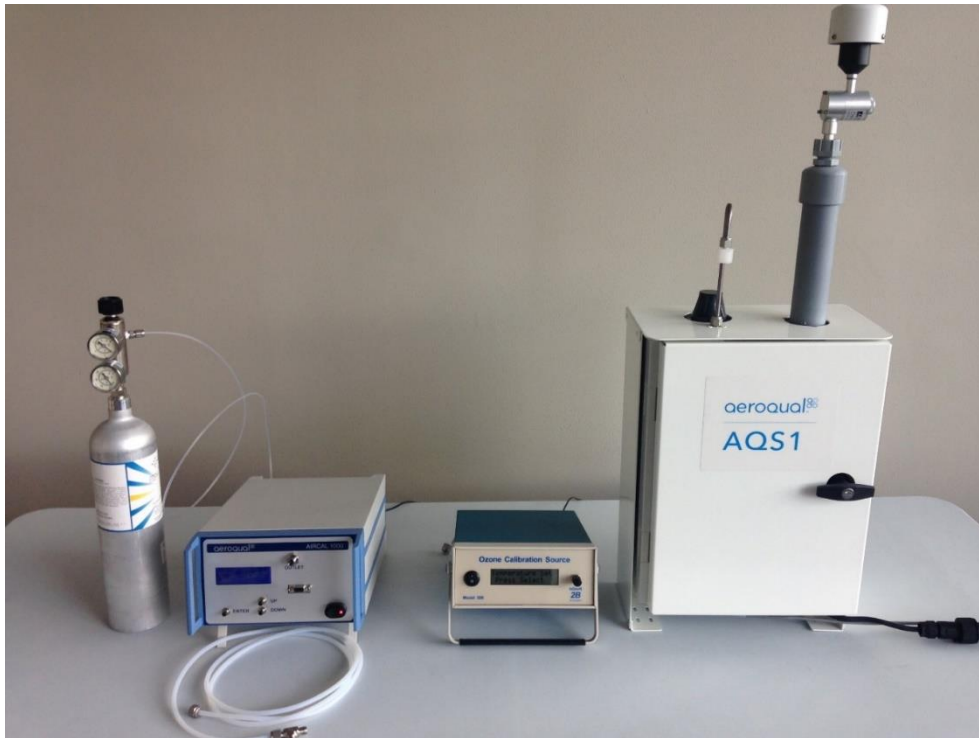

Figure 7-1 Centre: O3Cal Ozone calibrator. Left: AirCal 1000 with NO₂ cylinder from Calgaz.

NOTE: Both the AirCal 1000 and the Ozone calibrator take time to warm up and become stable.

- Turn on the AirCal 1000 and switch on the pump override switch on the back panel for at least 30 min before starting calibration.
- Turn on the Ozone generator and set it to deliver 0.1 ppm Ozone for at least 30 min before starting calibration, this allows time for the lamp in the ozone generator to stabilise at 0.1 ppm.

7.1.2 Calibration gases

Aeroqual cannot supply calibration gas cylinders, these must be purchased locally. Aeroqual recommends small size portable gas cylinders be purchased from Calgaz: www.calgaz.com.

Gas	Description	Calgaz Part number
NO ₂ (Nitrogen Dioxide)	20 ppm NO ₂ Balance AIR 8AL 58 litres C10 fitting	A0446046
C ₄ H ₈ (Isobutylene)	Isobutylene 1000 ppm Balance Air 6D 103 litres C10 fitting	A0436843

Table 7-1 Recommended gas cylinders from Calgaz.

A two-stage pressure regulator is required for use with these gas cylinders. Aeroqual can supply the regulator, part number **AIC GASREG01**, for use with C10 fitting. The Aeroqual regulator is shown attached to the Calgaz cylinder in Figure 5-1.

7.1.3 Flow meters for gas flow measurement

It is important to have a high-quality flow meter for the gas flow measurement.



Figure 7-2 Bios Dry Cal and AQS R8 HS high specification flow meters.

7.1.4 Gas module field calibration frequency

Typically, only advanced users will need to field calibrate their monitor. All other users can depend upon 12 monthly factory calibration of the gas module.

For some monitoring applications such as compliance monitoring the calibration frequency may be regulated. Some monitoring applications may require periodical validation of the data and field calibration is the best way to achieve this.

Field calibration frequency is a balance between cost and data quality objectives. Field calibration will incur cost of time and materials. Therefore, more frequent calibration costs more because it requires more time and materials.

At the high cost end of the spectrum are national ambient monitoring networks. The US EPA Quality Assurance Handbook (see <http://www.epa.gov/ttnamti1/qalist.html>) is a good example of how prescriptive calibration requirements for such applications can be.

Aeroqual makes the following recommendations about calibration frequency for the monitor:

- Follow all local regulatory calibration requirements if these are defined for the monitoring activity.
- Plan routine calibrations at an interval that is consistent with the data quality objectives for your monitoring purpose.
- Field calibration may be necessary if the gas module is operating out of specification and all other trouble-shooting steps have been taken.

Record your observations and calibration results in the calibration records.

- The service and calibration forms at the end of this document in Appendix 5 are used with this procedure, information arising from the calibration should be entered into the appropriate sections of the forms.
- The Journal feature in Connect/Cloud can also be used to record observations and make comments throughout the calibration process.

Assumptions

This SOP assumes the monitor and calibration equipment are in good working condition and the monitor is “ready for calibration”.

- The monitor has been running for at least 6 hours.
- The gas lines and inlet filter are clean.
- You are familiar with the operation of all the calibration equipment.
- All calibration equipment, such as calibrators and gas bottles are working and within calibration where necessary.

You will need to know:

- The total flow rate measured last time the monitor was serviced. Record this in Table 5.
- The individual gas module flow rates last time the monitor was serviced. Record this in Table 6.
- The current gain and offset for each module. See Figure 3. Record these in Tables 7 and 8 in the Calibration form in Appendix 5.

You will need to bring:

- Gas inlet filters
- Gas dilution calibrator / Zero air generator (combined or separate ozone generator)
- Gas cylinders with suitable gas concentrations
- Flow meter: Aeroqual R7

Before you begin

NOTE: Both the AirCal 1000 and the Ozone calibrator take time to warm up and become stable.

- Turn on the AirCal 1000 and switch on the pump override switch on the back panel for at least 30 min before starting the calibration.
- Turn on the Ozone generator and set it to deliver 0.1 ppm Ozone for at least 30 min before starting the calibration, this allow time for the lamp in the ozone generator to stabilise at 0.1 ppm.

The Calibration screen in the Calibration and Service App in the Aeroqual software is where you will perform the calibration and change any monitor settings.

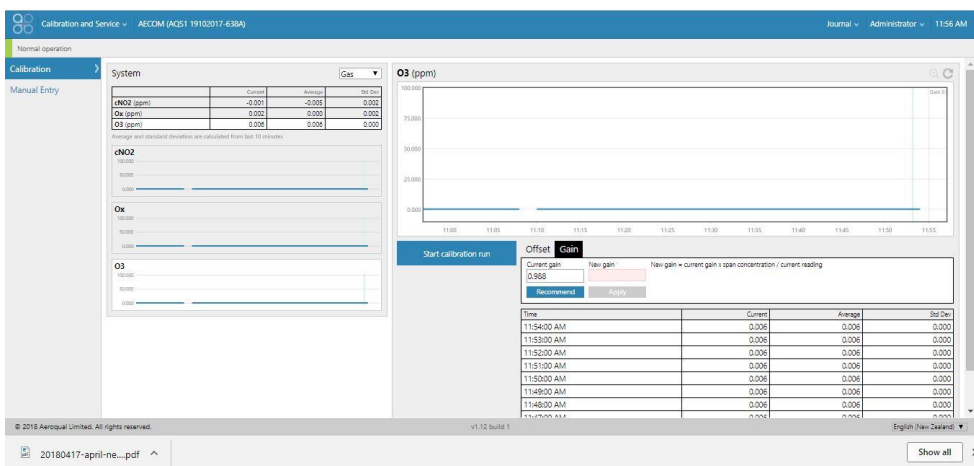

Figure 7-3 The main calibration screen is where the average and standard deviation can be read. This is also where the gain and offset can be read and set.

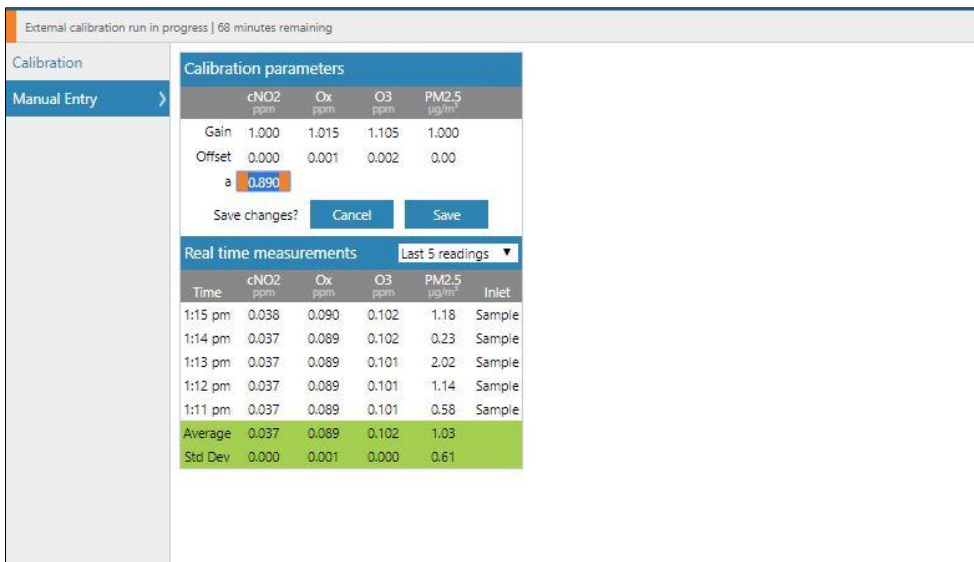

Figure 7-4 The Manual Entry section of the Calibration and Service App is where the gain and offset and the a value on the NO2 module is set.

NOTE: The connection to the monitor inlet differs depending on whether you are using the AirCal 1000 or the Ozone calibrator. See images below for how the connections differ.

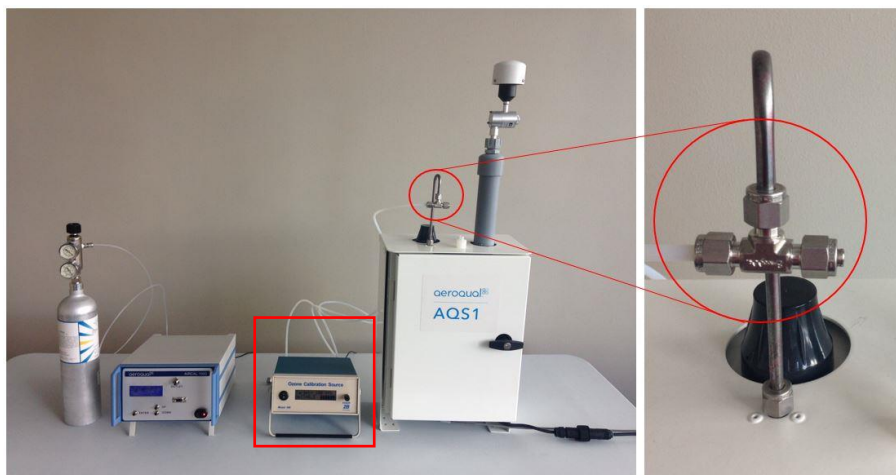

Figure 7-5 When using the Ozone calibrator, make sure the tee fitting is capped

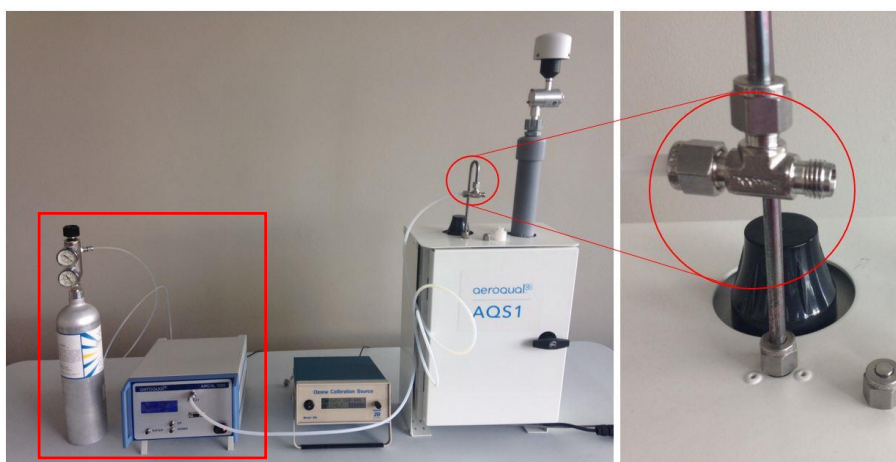

Figure 7-6 When using the AirCal 1000 make sure the tee is un-capped

7.1.5 NO₂ calibration overview (For monitors fitted with an Ox module pre-Dec 2019)

The NO₂ measurement is determined by the difference between two measurement modules; the O_x module and the Ozone module.

The O_x module responds towards both NO₂ and Ozone. The NO₂ concentration is determined by difference according to Equation 1.

$$[\text{NO}_2] = [\text{O}_x] - a[\text{O}_3]$$

The NO₂ **a** value is set at the Aeroqual factory and adjusts for the relative response of the O_x module towards ozone calibration gas.

The **a** value should be checked and adjusted as part of routine field calibration, see Figure 3b.

Note that only the **a** value is set for NO₂, the offset should be left at 0.000 and the gain should be left at 1.000.

NOTE: There are two ways to determine if you have an Ox module fitted;

1. Open the Calibration app, if Ox appears in the parameters and there is data then it is installed. See Figure 7-4. If there is no data, then the module may have been removed but not deleted from the sensor list.
2. Check the physical module in the instrument. The module gas type can be identified by checking the barcode label on the module – the code will include the designated monitor, gas type, and unique number sequence, e.g. AQM Ox 0-10ppm 0000000-000.

Below is a brief summary of the calibration steps for the NO₂/O₃ system. These steps must be carried out in the order described here. A detailed step by step process is described later in this document.

7.1.5.1 NO₂ calibration steps (For monitors fitted with an Ox module pre-Dec 2019)

NOTE: Gain and value adjustments vary as follows

- The Ox module gain adjustment is made during the NO₂ calibration gas delivery
- The NO₂ **a** value adjustment is made during the Ozone gas delivery
- The NO₂ gain value is NOT adjusted as part of the calibration process

1. Deliver zero air from the AirCal 1000 (or a suitable gas dilution calibrator) to the monitor.
2. Adjust the zero offset on the O_x and O₃ module is so that O_x and O₃ read zero. (Confirm NO₂ reads zero but do not adjust calibration settings on the NO₂ channel).
3. Deliver 0.1 ppm NO₂ gas from the calibrator.
4. Adjust **O_x gain** so the O_x reads 0.1 ppm.

NOTE: The NO₂ module should be reading 0.1 ppm during the 0.1 ppm Ox span calibration. The NO₂ may read slightly less than 0.1, this is normal, do not adjust the NO₂ gain.

5. Deliver zero air for 10 minutes to allow the sensors to return to baseline.
6. Then deliver 0.1 ppm Ozone.
7. Adjust O₃ gain so that the O₃ module reads 0.1. The Ox module will be showing a response towards Ozone during the O₃ calibration, this is expected.

If the NO₂ shows a response during the Ozone calibration, then a new **a** value must be calculated according to equation 3 and applied as shown in Figure 5-4.

$$[NO_2] = [Ox] - [aO_3] = 0.00$$

$$a = [Ox] / [O_3] \text{ span concentration}$$

Set the **a** value in the Manual Entry dialogue in the Service and Calibration App (**Figure 5-4**). Check the NO₂ reads zero under these conditions.

8. Deliver Zero air for 10 min to purge the gas lines before returning to sampling ambient air.

7.1.6 Calibration pre-checks:

You will need to record a range of details as part of the calibration process. Use the Calibration Record document in section 12.3.

The record capture tables are listed below:

Table	Details to record
1	Monitor, customer, and calibration technician details
2	Calibration equipment used
3	Calibration gas details
4	Changes to the local surroundings which may have an impact on the measurements
5	Monitor pre check results

Before you open the door

Monitor pre-checks

- 5.1 Put the monitor into Service Mode.
- 5.2 Check that the gas inlet is secure, if yes pass
- 5.3 Check that the particle inlet is secure, if yes pass
- 5.4 Check that door locks are operational, if yes pass
- 5.5 Measure and record the gas inlet flow rate
- 5.6 Record the previously measured flow rate, this value should be recorded in the monitor journal.

Open the door

NOTE: To keep the sensor readings stable, minimise the time the door is open.

- 5.7 Replace the inlet filters
- 5.8 Measure and record the inlet flow rate again after changing the filter.
 - If the inlet flow has changed compared to step 5.6, (but less than $\pm 20\%$) since last time it was measured then check the gas connections for obvious leaks, then use the flow adjustment valve to correct the flow.
 - If adjustment was unsuccessful then go to Step 6.
 - If the inlet flow has changed (more than $\pm 20\%$) since last time it was measured (step 5.6) then go to Step 6.

Close the door

- 5.9 Record the final total flow.

7.1.7 Check and adjust module flow rates

Table	Details to record
6	Monitor, customer, and calibration technician details

NOTE: It is important to have a high-quality flow meter to perform these flow checks. See Figure 9 2.

Flow checks in this section are performed separately for each module. One or more modules can fail the flow check, but others can pass. Calibration can continue on modules that pass, modules that fail can be removed and checked without affecting the calibration on the remaining modules.

- 6.1. Check all the individual gas connections for any obvious leaks.
 - If a leak is found then correct it, go back to Step 5.9.
- 6.2 Perform a leak check on the sampling manifold.
 - If a leak is found then correct it, go back to Step 5.9.
- 6.3 Measure the individual flow rates, then add up the flows to equal total module flow. Record the sum of the flows in the last column.
 - For each module, if the flow rate measured now equals the previously measured flow rate ($\pm 20\%$ LPM) then pass for that module, otherwise fail for that module.
 - If no specific module is causing a problem and all module flow rates are low, then go to 6.4 otherwise go to 6.6.
- 6.4 Adjust the flow rate using the bypass valve, circle yes if valve adjusted
- 6.5 Re-measure and record module flow rates for each module.
 - If the flow rate measured now equals the previously measured flow rate, then pass. Go to zero calibration.
 - For those modules which do not have the correct flow rate and cannot be corrected with the bypass valve then perform a leak check or check for blockages.
 - If the problem can be corrected then correct it, otherwise replace the module. Go to zero calibration.
 - If the problem cannot be resolved, then remove the module and cap off the gas connections. Record fail in the calibration report. Go to zero calibration.

NOTE: The total flow rate will be reduced because of the module which has been removed.

7.1.8 Zero Calibration

Table	Details to record
7	Zero calibration results

Zero calibration is performed simultaneously on all gas modules. One or more gas modules may fail a criterion for calibration and others can pass completely. It is acceptable to fail a module but continue with the zero calibration on the remaining modules, and to continue with a span calibration on those modules which passed their zero calibration.

It is recommended to leave any failed modules running in the monitor throughout the zero and span calibration process. After the calibration is complete on the remaining modules, then the door to the monitor can be opened and the failed modules can be removed for inspection.

The order in which modules should be zero calibrated is:

- 1) NO₂, 2) O₃, 3) PID

Monitors fitted with an Ox module.

1) O_x, 2) O₃, 3) PID

NOTE: When an Ox module is fitted, NO₂ does not have a zero or gain adjustment applied.

Use the AirCal 1000 to deliver zero air, connect the monitor to the AirCal 1000 with the tee open as shown in Figure 5-6.

7.2.1 Record the current offsets in Table 7, column 7.1.1. Start the zero air flowing. Make sure there is excess flow out from the tee at the monitor inlet as shown in Figure 5-6 with the tee open.

7.2.2 Wait for the module to stabilise. This means the standard deviation is within the acceptable range listed in Table 7. Column 7.2.3 (c).

If the values have not stabilised, then write **fail** in the last column in Table 7 column 7.2.7 for this module. Move on to next module and **go back to Step 7.2.1**.

7.2.3 Record the stabilised reading in Table 7, column 7.2.3 from the 10-minute average.

If the values are within the accepted range, listed in Table 7 column 7.2.3 (b) then no offset adjustment is required, write **pass** in column 7.2.7. Move on to next module and **go to Step 7.2.1**.

7.2.4 If the stabilised value is outside the acceptable range then an offset adjustment is required. Calculate and record the new offset using Equation 4.

$$\text{New offset} = \text{Current offset} + (\text{AQS gas reading} / \text{Gain})$$

You can use the calibration app “Recommend” button (Figure 7-3), this will perform the calculation, but you must accept this offset by pushing the “Apply” button, this will upload the new offset.

7.2.5 If the new calculated offset is within the acceptable range listed in Table 7 column 7.2.4 (b) then upload the new offset.

→ If the required offset is outside the recommend limits listed in Table 7 do not upload the offset, write **fail** in column 7.2.7. Move on to next module and **go back to Step 7.2.1**.

7.2.6 After 2 or 3 minutes record the readings after the new offset has been uploaded. Confirm the readings are within acceptable limits.

→ If yes then **pass**, if not then **fail**. Move on to next module and **go to Step 7.2.1**.

7.1.9 Span Calibration

Table	Details to record
8	Span calibration results

Span Calibration is performed separately in sequence for each gas module. Span calibration should only be performed on modules that have been successfully Zero calibrated.

It is recommended to leave any failed modules running in the monitor throughout the zero and span calibration process. After the calibration is complete on the remaining modules, then the door to the monitor can be opened and the failed modules can be removed for inspection.

8.1.1 Start here for each module. Once all modules have been span calibrated go to Step 9.

- For monitors with an Ox module fitted (pre-Dec 2019) go to section 7.1.10
- Record all initial gains in Table 8 Column 8.1.1

8.1.2 Start the calibration gas flowing at your chosen span point, Aeroqual recommends 0.1 ppm. Make sure there is excess flow out from the tee at the monitor inlet as shown in Figure 7-5.

8.1.3 Record the span gas concentration. In Table 8 column 8.1.3.

8.1.4 Wait for the module values to stabilise to the span gas, this means the readings are within the acceptable noise limits listed in Table 8 Column 8.1.5 (c).

If the values have not stabilised, then write **fail** in the column 8.1.10. Move on to next module and **go to Step 8.1.1**.

If the values are stable and within the accepted range listed in Table 8 Column 8.1.5 (b) then write **pass** in column 8.1.10. Move on to next module and **go to Step 8.1.1**.

- 8.1.6 If the values are stable but outside the acceptable range listed in Table 8 Column 8.1.5 (b) then a new gain must be calculated and applied.

$$\text{New Gain} = \text{Current Gain} \times (\text{Span concentration} / \text{Gas reading})$$

You can use the calibration app “Recommend” button (Figure 7-3), this will perform the gain calculation, but you must accept this gain by pushing the “Apply” button, this will upload the new gain.

NOTE: The calibration app restricts the gain between 0.2 and 5.0. The manual entry screen will allow the gain to be set outside these limits.

- 8.1.7 Calculate and record the ratio of the gain change by using Equation 6. Record the ratio in Table 8, column 8.1.7.

$$\text{Gain Change Ratio} = \text{New Gain} / \text{Current Gain}$$

- 8.1.8 If the calculated gain is within acceptable limits listed in Table 8 Column 8.1.5 (d), upload the new gain.

If the required gain is outside the recommend limits do not upload the gain, write **fail** in the column 8.1.10. Move on to next module and **go to Step 8.1.1**.

- 8.1.9 Confirm the readings are within acceptable limits.

If yes then write **pass** in column 8.1.10, if not then write **fail**. Move on to next module and **go to Step 8.1.1**.

- 8.1.10 Deliver zero air for 10 minutes to purge the gas lines.

NOTE: Change the gas connection from the AirCal 1000 over to the Ozone calibrator. Make sure to cap the end of the tee as shown in Figure 7-5.

- 8.1.11 Deliver ozone from the ozone calibrator at your chosen span point, Aeroqual recommends 0.1 ppm, make sure the tee is closed using the cap as shown in Figure 7-5.

NOTE: It takes a while for the ozone delivery to stabilise at the chosen span point, you should have previously set the output of the ozone generator to your chosen span point and left the generator running at this span point for at least 30 min, to allow the output to stabilise.

- 8.1.12 Record the ozone span concentration in Table 8 Column 8.1.3.

- 8.1.13 Wait for the O₃ values to stabilise towards O₃ calibration gas, as described in Table 8 Column 8.1.5 (c) If the values have not stabilised then write **fail** in the last column.

- 8.1.14 Record the stabilised **O₃ values** in Table 8 Column 8.1.5 from the 10-minute average. If the values are stable and within the accepted range listed in Table 8 column 8.1.5 (b), then no gain change is required, then write **pass** in column 8.1.10.

- 8.1.15 If the values are stable but outside the acceptable range Calculate and record new O₃ gain using Equation 5.

$$\text{New Gain} = \text{Current Gain} \times (\text{Span concentration} / \text{Gas reading})$$

You can use the calibration app “Recommend” button (Figure 7-3), this will perform the gain calculation, but you must accept this gain by pushing the “Apply” button, this will upload the new gain.

- 8.1.19 Turn off the Ozone gas and return the monitor sampling zero air from the AirCal 1000.

NOTE: Change the gas connection from the Ozone calibrator over to the AirCal 1000 calibrator. Make sure to remove the cap from the end of the tee as shown in Figure 7-6.

- 8.1.19 If your monitor contains a PID gas module, repeat steps 8.1.2 to 8.1.10 for PID.

7.1.10 Span Calibration for monitors fitted with an Ox module (pre-Dec 2019)

Table	Details to record
8	Span calibration results

When an Ox module is fitted (pre Dec 2019), the order in which modules are span calibrated is very important, see section 7.1.5

- 1) O_x gain (using NO₂ calibration gas),
- 2) O₃ gain (using O₃ calibration gas),

3) NO₂ **a** value (using O₃ calibration gas),

4) PID **gain** (using Isobutylene calibration gas)

NO₂ does not have a zero or gain adjustment applied when an Ox module is fitted.

The NO₂ calibration, (**a** adjustment) should be performed at the appropriate step during the Ozone span gas delivery, Step 8.1.16

Record the initial NO₂ **a value in Table 8 Column 8.1.2.**

8.1.2 Start the NO₂ calibration gas flowing at your chosen span point, Aeroqual recommends 0.1 ppm. Make sure there is excess flow out from the tee at the monitor inlet as shown in Figure 5-6.

8.1.3 Record the span gas concentration. In Table 8 column 8.1.3.

8.1.4 Wait for the O_x module values to stabilise to the NO₂ span gas, this means the readings are within the acceptable noise limits listed in Table 8 Column 8.1.5 (c).

If the values have not stabilised, then write **fail** in the column 8.1.10. Move on to next module and **go to Step 8.1.1.**

NOTE: *If the O_x module fails calibration then the NO₂ measurement cannot be used. The O₃ module can calibrated even if the O_x module fails calibration.*

8.1.5 Record the stabilised O_x values in the calibration form Table 8 Column 8.1.5 from the 10-minute average

If the values are stable and within the accepted range listed in Table 8 Column 8.1.5 (b) then write **pass** in column 8.1.10. Move on to next module and **go to Step 8.1.1.**

8.1.6 If the values are stable but outside the acceptable range listed in Table 8 Column 8.1.5 (b) then a new gain must be calculated and applied. Calculate and record new Ox gain using Equation 5.

$$\text{New Gain} = \text{Current Gain} \times (\text{Span concentration} / \text{Gas reading})$$

You can use the calibration app “Recommend” button (Figure 7-3), this will perform the gain calculation, but you must accept this gain by pushing the “Apply” button, this will upload the new gain.

NOTE: *The calibration app restricts the gain between 0.2 and 5.0. The manual entry screen will allow the gain to be set outside these limits.*

8.1.7 Calculate and record the ratio of the gain change by using Equation 6. Record the ratio in Table 8, column 8.1.7.

$$\text{Gain Change Ratio} = \text{New Gain} / \text{Current Gain}$$

8.1.8 If the calculated gain is within acceptable limits listed in Table 8 Column 8.1.5 (d), upload the new gain.

If the required gain is outside the recommend limits do not upload the gain, write **fail** in the column 8.1.10. Move on to next module and **go to Step 8.1.1.**

8.1.9 Record the O_x readings after the new O_x gain has been uploaded. Confirm the readings are within acceptable limits.

If yes then write **pass** in column 8.1.10, if not then **fail**. Move on to next module and **go to Step 8.1.1.**

8.1.10 Deliver zero air for 10 minutes to purge the gas lines.

NOTE: *Change the gas connection from the AirCal 1000 over to the Ozone calibrator. Make sure to cap the end of the tee as shown in Figure 5-5.*

8.1.11 Deliver ozone from the ozone calibrator at your chosen span point, Aeroqual recommends 0.1 ppm, make sure the tee is closed using the cap as shown in Figure 5-5.

NOTE: *It takes a while for the ozone delivery to stabilise at the chosen span point, you should have previously set the output of the ozone generator to your chosen span point and left the generator running at this span point for at least 30 min, to allow the output to stabilise.*

8.1.12 Record the ozone span concentration in Table 8 Column 8.1.3.

8.1.13 Wait for the O₃ values to stabilise towards O₃ calibration gas, as described in Table 8 Column 8.1.5 (c) if the values have not stabilised then write **fail** in the last column.

NOTE: If the O₃ module fails calibration then the NO₂ measurement cannot be used.

8.1.14 Record the stabilised **O₃ values** in Table 8 Column 8.1.5 from the 10-minute average. If the values are stable and within the accepted range listed in Table 8 column 8.1.5 (b), then no gain change is required, then write **pass** in column 8.1.10.

8.1.15 If the values are stable but outside the acceptable range Calculate and record new O₃ gain using Equation 5.

$$\text{New Gain} = \text{Current Gain} \times (\text{Span concentration} / \text{Gas reading})$$

You can use the calibration app “Recommend” button (Figure 7-3), this will perform the gain calculation, but you must accept this gain by pushing the “Apply” button, this will upload the new gain.

8.1.16 Wait for the **O_x values** to stabilise towards O₃ calibration gas. After the O_x values have stabilised calculate the **a** value. The **a** value is calculated according to this equation:

$$a = \text{Ox reading} / \text{O3 span concentration}$$

The **a** value should be in the range 0.3 to 1.5. If your calculated **a** value falls outside this range do not change the **a** value, contact Aeroqual for technical support:

technical@aeroqual.com.

8.1.17 Upload the **a** value in the manual entry screen shown in Figure 5-4. Record the new **a** value in Table 8 column 8.16b.

8.1.18 **After the O_x and O₃ gains, and the a value have been applied**, record the NO₂ readings in Table 8 Column 8.1.9. Do not adjust any calibration settings of the NO₂ channel.

8.1.19 Turn off the Ozone gas and return the monitor sampling zero air from the AirCal 1000.

NOTE: Change the gas connection from the Ozone calibrator over to the AirCal 1000 calibrator. Make sure to remove the cap from the end of the tee as shown in Figure 7-6.

7.1.11 Post-calibration checks

Table	Details to record
9	Post-calibration checks

Follow these post-calibration checks and record the results in Table 9 from the Calibration form in Appendix 5.

- 9.1 Disconnect calibration equipment
- 9.2 Record the inlet flow rate
- 9.3 Replace the mesh inlet and cap
- 9.4 Lock door
- 9.5 Secure the site
- 9.6 Take monitor out of service mode and record the time in the form.

7.2 Particle Monitor calibration

Field calibration of monitor with Particle Monitor is typically not required.

However, in some applications that have very high data quality objectives, field calibration may be appropriate. Such applications may include:

- Supplementary monitoring to a reference network (so inter-comparison to reference is important)
- Research studies that need to demonstrate traceability to another monitor
- Consultancy projects that need to demonstrate traceability to another monitor

In summary, field calibration of Aeroqual PM monitors is recommended only when comparison or traceability to reference PM monitors is an important factor in the monitoring project.

For all other applications the Aeroqual factory calibration is enough.

All PM monitors are calibrated at the factory against a standard aerosol (NIST traceable monodisperse spheres). The factory calibration is traceable and results in good data quality when the monitor is operated in accordance with Aeroqual’s servicing and maintenance procedures.

7.2.1 Factory servicing and calibration

Factory servicing includes cleaning and calibration of the PM module only. The PM module can be removed from the monitor and returned to the factory. All Aeroqual PM Modules need to be returned to the factory for service and calibration at the following intervals:

- Dust Sentry Particle Monitor: 24 Months
- Dust Sentry Particle Profiler 12 Months

NOTE: *Field calibration is not a substitute for the specified factory service intervals above. Factory servicing is essential maintenance and check the 'health' of the internal components.*

7.2.2 Field calibration

In order to perform a field calibration, your Aeroqual monitor must be located at the same site as a **Reference** PM monitor. This is called '**Co-location**' and is widely performed in ambient air quality monitoring to assess the performance of a new monitor. The two monitors are operated for a given period, and their data are compared. An adjustment factor, called '**K Factor**' is then calculated, and applied to the Aeroqual monitor **Gain**. This corrects the data to the known reference monitor.

$$K \text{ Factor} = \frac{\text{Average PM (Reference)}}{\text{Average PM (Aeroqual)}}$$

The K Factor is the applied to the monitor, using the Gain setting for each PM channel:

$$\text{New Gain} = \text{Old Gain} \times K \text{ Factor}$$

You can also perform the adjustment in Microsoft excel or similar.

Field calibration is only as good as the reference data which is used. Using poor quality reference data for calibration will result in poor quality PM data from your Aeroqual monitor. Aeroqual recommends that calibration only be carried out using high quality Reference PM Data. If you don't have access to a reference monitor or aren't confident that you can access a well-run reference monitor, then you should always rely upon the factory calibration.

Important considerations for field calibration:

- Location of monitor: The Aeroqual monitor and the Reference monitor need to be located at the same site preferably with their inlets within 10 m of each other and must be sampling at the same height. At reference sites using a monitoring shed, on the rooftop of the shed is usually the best location.
- Monitor set up: Both the Aeroqual monitor and the reference monitor need to be set up in accordance with the manufacturer's recommendations, with correctly set flow rates and fresh filters. If you are using a gravimetric method reference monitor, you must follow appropriate filter conditioning and weighing methods.
- Duration of colocation: As a rule, longer is better, as this will give you more data points and therefore more confidence in your field calibration. It's important that the colocation is carried out during the same environmental conditions expected during deployment. 1-2 weeks is preferred and no shorter than 48 hrs.
- Reference monitor selection: Selection of the right reference monitor is critical for a successful K factor correction. Ideally, reference monitors should be operated in accordance with local reference method specification. Monitor methods are listed below, in descending order of preference:
- GRIMM / BAM / TEOM: Are best as they are continuous methods, meaning more data can be collected in a shorter period, giving a more accurate K-Factor. BAM data can be noisy at hourly averages, so consider using 24 hr averages if PM levels are low. This is Aeroqual's suggested method, as lots of data can be collected quickly, with no need for expensive lab work.
- Partisol / Low volume samplers (47mm Filter): Can also be used, however will need to be run for a longer period as they operate on 24 hr averages (i.e. 1 data point per 24 hrs). Filters must be appropriately prepared and transported. Lab and field blank filters should also be used. Balance accuracy for pre and post weighing should be better than $\pm 0.0001 \mu\text{g}$. High-Volume samplers
- Other Non-Reference methods (Optical, Open-Path): Existing instrumentation can be used to establish variance between Aeroqual and a known monitor. This method can be used to assess new versus old instrumentation but is not a calibration to a reference monitor.

7.2.3 Steps to performing a K factor correction

Beta Attenuation Monitors (BAM) measure PM loading on a filter tape, using a radioactive source and a detector. The amount of PM measured is proportional to the amount of beta rays which are blocked from passing from the source to detector by the PM on the filter tape. TEOMs use a high precision microbalance with a special filter to calculate PM concentration. BAM and TEOM monitors run continuously and data is available at as low as 10-minute averages. This data can be noisy, so Aeroqual recommend that 1 hour or 24 hr averages are used to minimise this noise.

Gravimetric methods (Partisol, Low volume samplers using 47 mm filters) have some additional steps. It is critical that correct filter conditioning and pre/post weighing processes are carried out.

- Install and commission your Aeroqual monitor alongside your reference monitor. Operate both monitors together. The longer you collocate the monitors, the better.
- Collect the data from both monitors. Using Microsoft Excel or similar, remove any odd spikes, error, or automated zero calibration data.
- (Gravimetric only) calculate your concentrations using the following equation:

$$\text{Concentration} = \frac{\text{Filter weight at end} - \text{filter weight at start}}{\text{Total volume of air sampled}}$$

- Select an appropriate averaging period, 24 hrs is usually appropriate. Calculate your averages for both reference and Aeroqual using this formula:

$$\text{Average} = \frac{\text{Sum of readings}}{\text{Number of readings}}$$

- The goal is to create an excel spreadsheet, with 1 column of reference data, and 1 column of Aeroqual data, in the averaging period you have selected, for instance 1 hour or 24 hour or 24 hr averages for the period of your co location.

NOTE: Your zero check data should be included as a point.

Dust Monitor side-by-side calibration data		
10 June to 21 June Monitoring site 1		
Date	Reference Gravimetric, daily mass ug m-3	Aeroqual Dust Monitor daily average ug m-3
10/06/12	12.0	14.8
11/06/12	27.2	43.9
12/06/12	34.5	50.1
13/06/12	10.0	14.9
14/06/12	9.3	15.1
15/06/12	31.7	52.8
16/06/12	43.1	73.7
17/06/12	52.3	73.6
18/06/12	23.2	27.2
19/06/12	10.7	16.2
20/06/12	13.5	15.6
21/06/12	11.9	16.3

- Using Microsoft excel plot your 2 data sets in an x-y scatter plot. Add a trend line and equation as below.

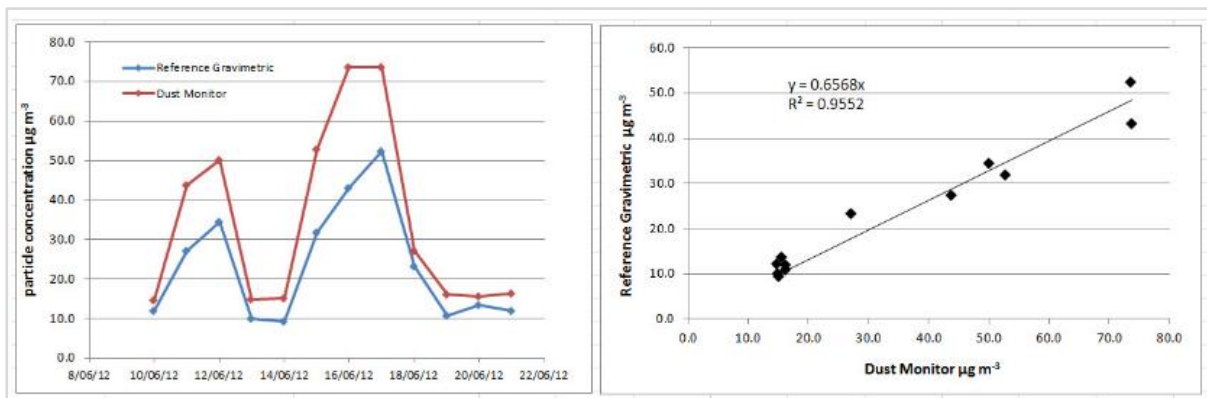

- The graph to the left below shows the time series of the two monitors. The graph to the right below shows the slope calculation. In this example the Monitor is reading higher than the reference monitor. The slope of the curve Reference vs Dust Monitor is 0.6568. So, a gain of 0.6568 needs to be applied to the monitor.

The Aeroqual monitor will need a new gain, calculated using the formula below:

$$\text{New Gain} = \text{Old Gain} \times K \text{ Factor}$$
$$\text{New Gain} = 1 \times 0.6568 = 0.6568$$

Upload the new gain into the gain parameter in the gain and offset table using the calibration and service app.

The screenshot shows the 'Gain and Offset' configuration screen in the Aeroqual calibration app. At the top, there is a 'Manual service mode' section with a green 'Start' button. Below this is the 'Calibration parameters' section, which contains a table with the following data:

Setting	PM10 µg/m ³	ITEMP °C	TEMP °C	RH %
Gain	0.6568	1.000	1.000	1.000
Offset	0.00	0.0	0.00	0.0

Below the table, there are 'Save changes?' buttons: 'Cancel' and 'Save'. The bottom section is titled 'Real time measurements' and includes a dropdown menu for 'Last 5 readings'. It contains a table with the following data:

Time	PM10 µg/m ³	ITEMP °C	TEMP °C	RH %	Inlet
4:39 pm	5.46	30.3	24.51	26.3	Sample
4:38 pm	5.31	29.7	24.48	26.4	Sample
4:37 pm	5.44	29.8	24.44	26.4	Sample

8 Troubleshooting

The following section provides basic troubleshooting for the monitor. Common problems, and how to solve them are given in Table 8-1

Not all known issues are listed in Table 8-1 especially if not known to Aeroqual when this user guide was written. The Aeroqual training website provides a comprehensive and up to date list of known issues and provides solutions as soon as solutions become available.

	Online reference	training.aeroqual.com DM 1.3 Tech training
---	------------------	---

The Aeroqual technical support team are available to help when required.

	Online reference	technical@aeroqual.com
---	------------------	--

Use manual sync to assist Aeroqual technical support in troubleshooting

When the Aeroqual technical support team are required to help with troubleshooting it is necessary to see a comprehensive dataset from the Dust Sentry. This can easily be achieved if the instrument is online.

If the instrument is not online, use the Manual Sync tool (Section 5.1.4) to upload data to Aeroqual Cloud so the technical support team can provide fast and comprehensive support.

Error conditions reported by Aeroqual Connect and Aeroqual Cloud software

Connect and Cloud software will report two different types of error condition in the banner at the top of the page, these are ‘sensor offline’ and ‘sensor failed’ The error will also be listed in the monitor journal.

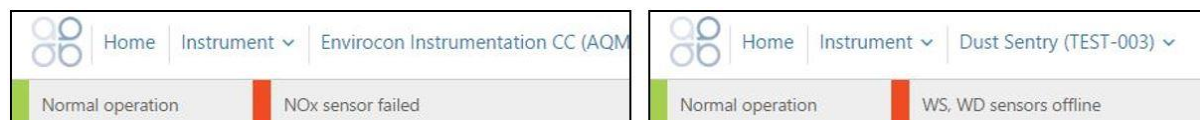

Sensor offline

A sensor offline error is usually caused by either a loose power connection or a loose communications connection. Check the module connections are secure. If the power connections and the communications connections are secure, then the issue may be inside the module.

Contact the Aeroqual distributor in your local country for technical support.

Sensor failure

A sensor failure error can occur for different reasons, sometimes this can be related to a sensor parameter exceeding an allowable value.

If you get a ‘sensor failure’ error contact the Aeroqual distributor in your local country for technical support.

Communication errors:

1. Failure to see the WIFI network broadcast by the monitor

If you cannot see the monitor in your list of WIFI networks, it is most likely because the WIFI setting is set to ‘Client Mode’ and is not broadcasting. See section 4.1.

To resolve this, connect to the monitor through the WIFI LAN and then reset the WIFI mode to ‘Access Point’.

Alternatively, the monitor can be reset to factory communication settings by using the USB reset procedure. See section 4.4.

2. Error 500 Database error

An error is known to occur with the internal database which causes the following error report when trying to connect to the monitor. This may be able to be resolved over a remote connection. Or a component in the embedded PC will need to be replaced.

Application Exception

System.Exception

Unable to connect to database!

Description: HTTP 500.Error processing request.

Details: Non-web exception. Exception origin (name of application or object): AeroqualProviders.

Exception stack trace:

```

at Aeroqual.Providers.DataProvider.InitDatabase
(System.String connectionString) [0x000000] in <filename unknown>:0
at Aeroqual.Providers.DataProvider.set_ConnectionString (System.String
value) [0x000000] in <filename unknown>:0
at AeroqualCloud.WebApiApplication.Application_Start () [0x000000] in
<filename unknown>:0
at (wrapper managed-to-native)
System.Reflection.MonoMethod:InternalInvoke
(System.Reflection.MonoMethod,object,object[],System.Exception&)
at System.Reflection.MonoMethod.Invoke (System.Object obj,
BindingFlags invokeAttr, System.Reflection.Binder binder,
System.Object[] parameters, System.Globalization.CultureInfo culture)
[0x000000] in <filename unknown>:0
    
```

If this error occurs contact the Aeroqual distributor in your local country for technical support.

Symptom	Possible cause	Fault isolation / Solution	Reference
Gas module troubleshooting			
Negative readings	Flow leak or incorrect flow		Section 6.5.4
	Dirty inlet gas filter	Change filter	Section 6.5.5
	Incorrect zero calibration	Perform zero calibration	Section 2
Gas readings noisy or unstable	Flow leak or incorrect flow		Section 6.5.11
	Module is aging	Replace module	Section 6.5.12
Gas readings significantly different than expected	Incorrect gain or offset applied	Check the correct gain has been applied correctly	Section 7.2
	Incorrect calibration performed	Incorrect gas cylinder used, or gain calculated incorrectly	Redo calibration or identify error and correct it
Particle Monitor and Particle Profiler troubleshooting			
PM _{2.5} > PM ₁₀	Cyclones fitted on the wrong side	Swap cyclones to correct side	Section 0
	Auto zero calibration failing on the PM _{10.0}	Check baseline calibration of PM ₁₀	Section 6.5.8
	Incorrect gain applied	Check gain on module	Section 6
	Leak in flow system	Check for leaks	Section 6.5.7
Negative numbers	Auto zero calibration failing...	Check baseline calibration of PM ₁₀	Section 6.5.8.2
Readings lower than expected	Flow rate too low	Check flow rate change pump if required	Section 6.5.10
	Dirty optics	Have optical module serviced	Section 6.6
	Failed laser	Have optical module serviced	Section 6.6
	Dirty sample filters	Change filter	Section 6.5.5

Table 8-1 Common troubleshooting tasks and how to solve them

9 Copyright

Copyright Aeroqual Limited. All rights reserved. Reproduction, transfer, distribution or storage of part or all of the contents of this document in any form without the prior written permission of Aeroqual Limited is prohibited.

“Aeroqual” is a registered trademark of Aeroqual Limited. Other product and company names mentioned herein may also be trademarks or trade names.

Aeroqual operates a policy of continuous development. Aeroqual reserves the right to make changes and improvements to any of the products described in this document without prior notice.

Under no circumstances shall Aeroqual be responsible for any loss of data or income or any special, incidental, consequential or indirect damages howsoever caused.

The contents of this document are provided "as is". Except as required by applicable law, no warranties of any kind, either express or implied, including, but not limited to, the implied warranties of merchantability and fitness for a particular purpose, are made in relation to the accuracy, reliability or contents of this document.

Aeroqual reserves the right to revise this document or withdraw it at any time without prior notice. The availability of particular products may vary by region. Please check with the Aeroqual distributor nearest to you.

10 Compliance

1. The Aeroqual Dust Sentry, Dust Sentry Pro and AQS 1 comply with the following standards:
EN 61000-6-1:2001
EN 61000-6-3:2001
Part 15 of the FCC Rules. Operation is subject to the following two conditions: (1) these devices may not cause harmful interference, and (2) these devices must accept any interference received, including interference that may cause undesired operation.
2. The Aeroqual Dust Sentry PM₁₀ has achieved MCERT's certification for indicative ambient particulate monitor

This equipment has been tested and found to comply with the limits for a Class B digital device, pursuant to Part 15 of the FCC Rules. These limits are designed to provide reasonable protection against harmful interference in a residential installation. This equipment generates, uses and can radiate radio frequency energy and, if not installed and used in accordance with the instructions, may cause harmful interference to radio communications. However, there is no guarantee that interference will not occur in a particular installation. If this equipment does cause harmful interference to radio or television reception, which can be determined by turning the equipment off and on, the user is encouraged to try to correct the interference by one or more of the following measures:

- Reorient or relocate the receiving antenna.
- Increase the separation between the equipment and receiver.
- Connect the equipment into an outlet on a circuit different from that to which the receiver is connected.
- Consult your Aeroqual distributor or an experienced radio/TV technician for help.



11 Warranty

The monitor warranty policy can be found on the main company website: www.aeroqual.com/support/warranty

12 Appendix

12.1 Gas module design



Figure 12-1 Gas module sizes and key components labelled (Modules may vary from that shown)

The list of gas modules available for integration into the monitor is provided in Table 12-1.

GAS MODULE	RANGE	RESOLUTION	SENSOR TYPE	MODULE SIZE	MODULE FLOW RATE	NOISE		PRECISION	LINEARITY: % OF F.S.	DRIFT 24 HOUR		EXPECTED MODULE LIFETIME
						ZERO SPAN % OF READING	LOWER DETECTABLE LIMIT (2σ)			Zero; SPAN % OF FS		
O ₃	0 – 500 ppb	0.1 ppb	GSS	Small	110 – 130 ml / min ⁻¹	1 ppb; 1 %	1 ppb	2% of reading or 2 ppb	1.5 %	1 ppb; 0.2 %	2 – 3 years	
NO ₂ (Ox module)	0 – 500 ppb	0.1 ppb	GSE	Medium	55 – 65 ml / min ⁻¹	1 ppb; 1 %	1 ppb	2% of reading or 3 ppb	2 %	2 ppb; 1 %	2 – 3 years	
NO ₂ (Direct-read)	0 – 500 ppb	0.1 ppb	GSE	Medium	55 – 65 ml / min ⁻¹	1 ppb; 1 %	1 ppb	2% of reading or 2 ppb	2 %	2 ppb; 1 %	2 – 3 years	
VOC (Low range)	0-500 ppb	0.1 ppb	PID	Medium	55 – 65 ml / min ⁻¹	1 ppb; 1 %	1 ppb	2% of reading or 1 ppb	1 %	1 ppb; 1 %	2 – 3 years	
VOC (High range)	0 – 30 ppm	0.01 ppm	PID	Medium	55 – 65 ml / min ⁻¹	0.1 ppm; 1 %	0.05 ppm	<2% of reading or 0.05 ppm	2 %	0.1 ppm; 1 %	2 – 3 years	

Table 12-1 Gas modules available for integration into the monitor

NOTE: O₃, Ox and NO₂ Modules have no serviceable parts. The VOC analyzer module uses a replaceable 10.6 eV UV lamp, if the lamp needs replacing contact the Aeroqual distributor in your local country for technical support.

12.1.1 Gas Module design

Gas modules come in two different designs. These two designs are shown schematically in Figure 12-1. A list of which gas modules use which design is given in Table 12-1.

- **Direct design** (Ozone): The gas is passed directly to the sensor continuously.
- **Zero switching design** (VOC and NO₂): The module uses a solenoid to switch between a zero path which removes the target gas and creates a “zero” or baseline measurement, and a measurement path which measures the ambient air. The final measurement in ppm is an arithmetic combination of the zero and sample measurement. This technique is referred to as Automatic Baseline Correction.

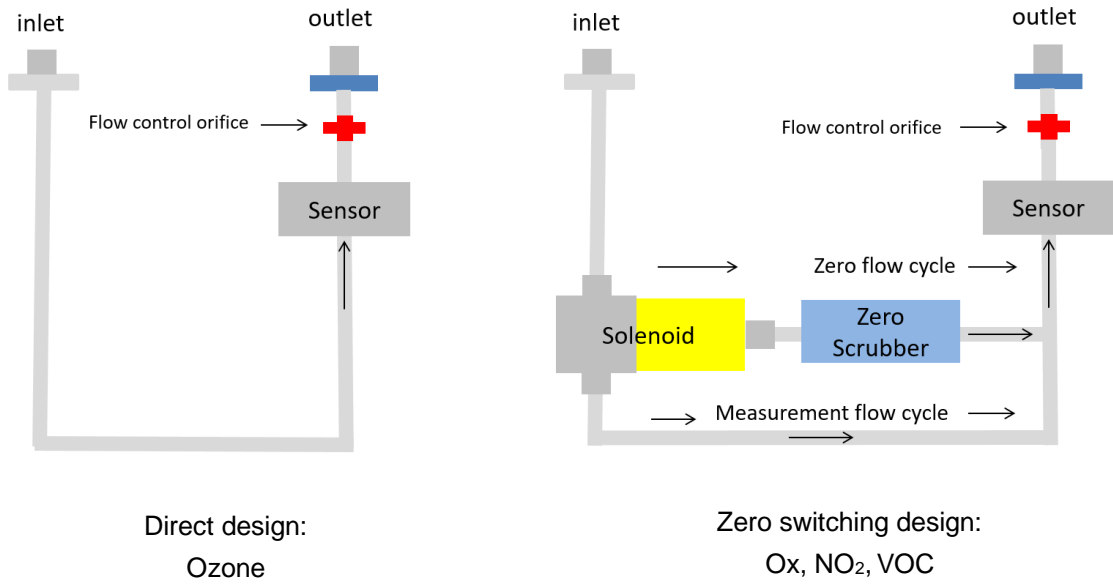

Figure 12-2 Direct and Zero switching gas module design

The gas flow rate is controlled using a critical orifice shown in red in Figure 12-2. The flow rate is listed in Table 12-1.

Each gas module contains: a gas inlet port (white ring), a gas exhaust port (blue ring), two 12 V power connectors to allow the module to be connected to a 12 V power bus, two RJ-45 connections to allow the module to be connected to the RS-485 communications bus, and a module status LED.

12.1.2 Gas flow through modules

The gas flow through all the gas modules is powered by a single diaphragm pump inside the monitor enclosure. The pump pulls sample air through the gas module. **After** it has been measured the sample air passes through the pump and is exhausted outside the monitor.

There are two different types of tubing material used to handle the gas flow.

- Before the gas reaches the sensor, all the tubing material is rigid non-reactive PFA.
- After the sample has passed the sensor all the tubing is flexible R3603 Tygon

The vacuum side of the pump is to the gas outlet (exhaust) of each module with **Tygon** tubing. This is illustrated in Figure 12-3.

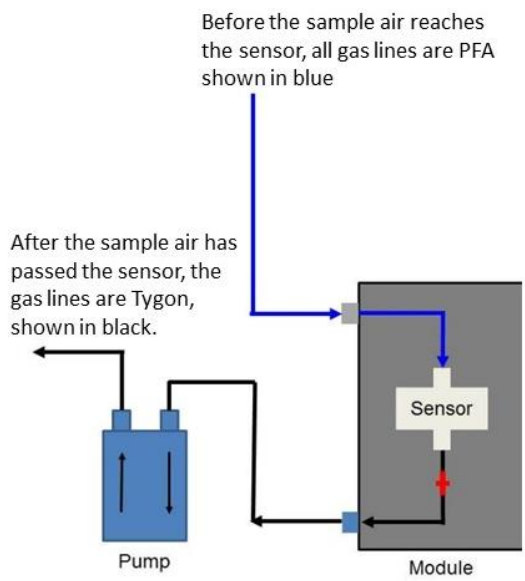

Figure 12-3 A single pump is used for all gas modules. The vacuum port of the pump is connected to the outlet of each gas module

12.2 Particulate Matter module design

The Dust Sentry can measure a range of pre-defined particulate matter (PM) such as TSP, PM₁₀, PM_{2.5} or PM₁. The sample flow for the particle measurements is separate from the gas sample flow. There is a separate pump, a separate inlet and a separate exhaust.

The Dust Sentry can measure particulate matter such as PM₁₀ and PM_{2.5}. There are **three** separate modules:

1. for measuring the particulate (optical engine), there are two options to choose from:
2. Particle Monitor uses a nephelometer combined with a sharp cut cyclone (See Figure 12-4) and measures a single size fraction such as TSP or PM₁₀ or PM_{2.5} or PM₁.
3. Particle Profiler uses an optical particle counter (See Figure 12-6) and measures four size fractions simultaneously, TSP and PM₁₀ and PM_{2.5} and PM₁.
4. for handling the data transfer (I/O module)
5. for controlling the flow rate (pump module)

The sample flow for the Particle Monitor and Particle Profiler is separate from the gas sample flow. There is a separate pump, a separate inlet and a separate exhaust.

12.2.1 Comparison between the Particle Monitor and the Particle Profiler

- The Particle Profiler measures particulate concentrations using particle counting, it outputs multiple size fractions at the same time.
- The Particle Profiler can measure TSP and PM₁₀ and PM_{2.5} and PM₁ without requiring a sharp cut cyclone.
- The Particle Monitor measures particulate concentrations by nephelometry; it measures TSP or PM₁₀ or PM_{2.5} or PM₁ using a sharp cut cyclone.

	Particle Monitor	Particle Profiler
Mass outputs	TSP or PM ₁₀ or PM _{2.5} or PM ₁	TSP and PM ₁₀ and PM _{2.5} and PM ₁
Particle count outputs	No	Yes
Accuracy	<± (2 µg/m ³ + 5% of reading)	<± (5 µg/m ³ + 15% of reading)
Factory calibration period	Every two years (24 months)	Every year (12 months)
Inlet flow rate	2.0 LPM	1.0 LPM

Table 12-2 Summary of the difference between the Particle Monitor and the Particle Profiler.

12.2.2 Particle Monitor module

The Particle Monitor uses a custom Met One near forward light-scattering nephelometer to measure particle concentration and a sharp cut inlet cyclone to physically select the particle size. This module is shown on the far right in Figure 12-4.

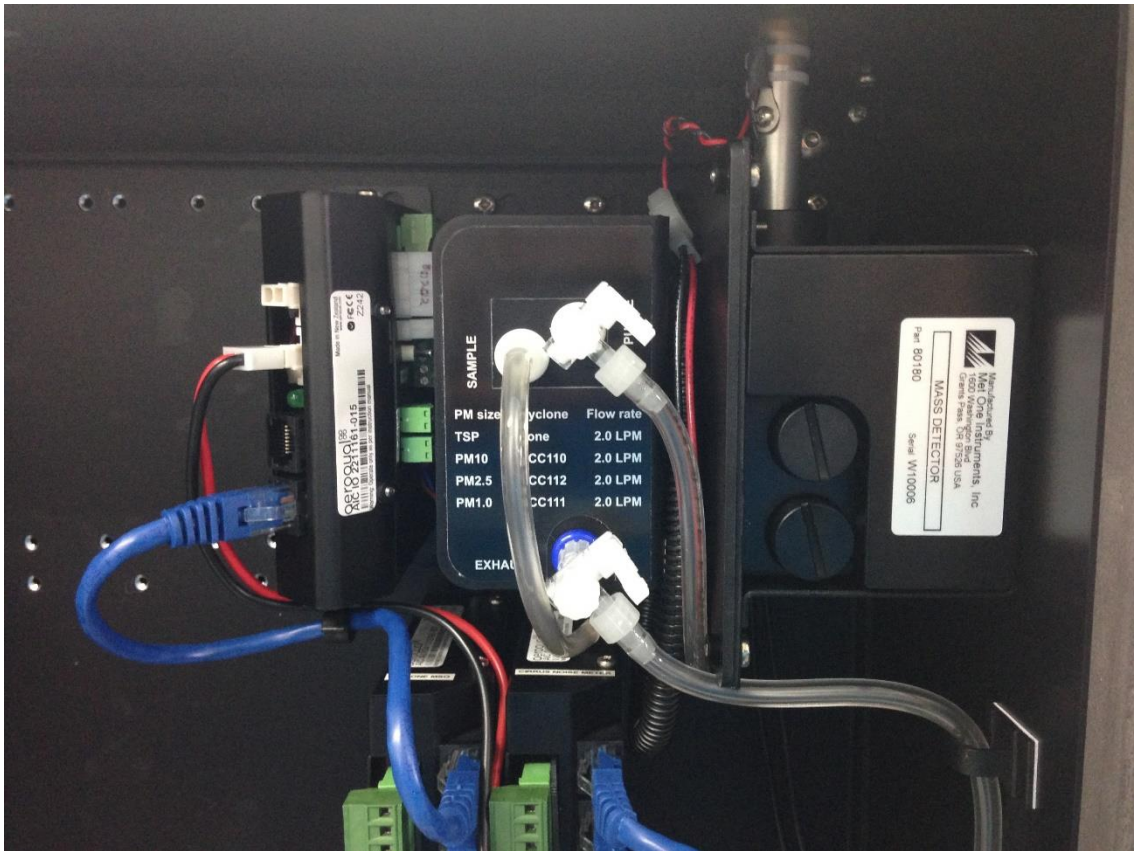

Figure 12-4 The Particle Monitor uses three modules: a) the optical engine on the far right, b) the pump module in the middle, c) the I/O module on the left (configuration is subject to change)

The particulate size selection (TSP or PM₁₀ or PM_{2.5} or PM_{1.0}) is determined by the sharp cut cyclone on the Particle Monitor inlet on the outside of the Dust Sentry shown in Figure 12-5. The Particle Monitor can be configured to measure either of these four size fractions simply by changing the inlet cyclone and making a small change in the software.



Figure 12-5 The size selection in the Particle Monitor is determined by the sharp cut cyclone on the inlet.



12.2.3 Particle Profiler module

The Dust Sentry uses a custom-designed Met One optical particle counter (OPC) to measure four particle size fractions simultaneously. There is no sharp cut cyclone used in the Particle Profiler; both the concentration and size are measured inside the optical particle counter.

The three modules for the Particle Profiler are installed in the top right side of the Dust Sentry enclosure.

The Particle Profiler has the sample and purge filters mounted on the outside of the optical module, (in the Particle Monitor they are held inside).

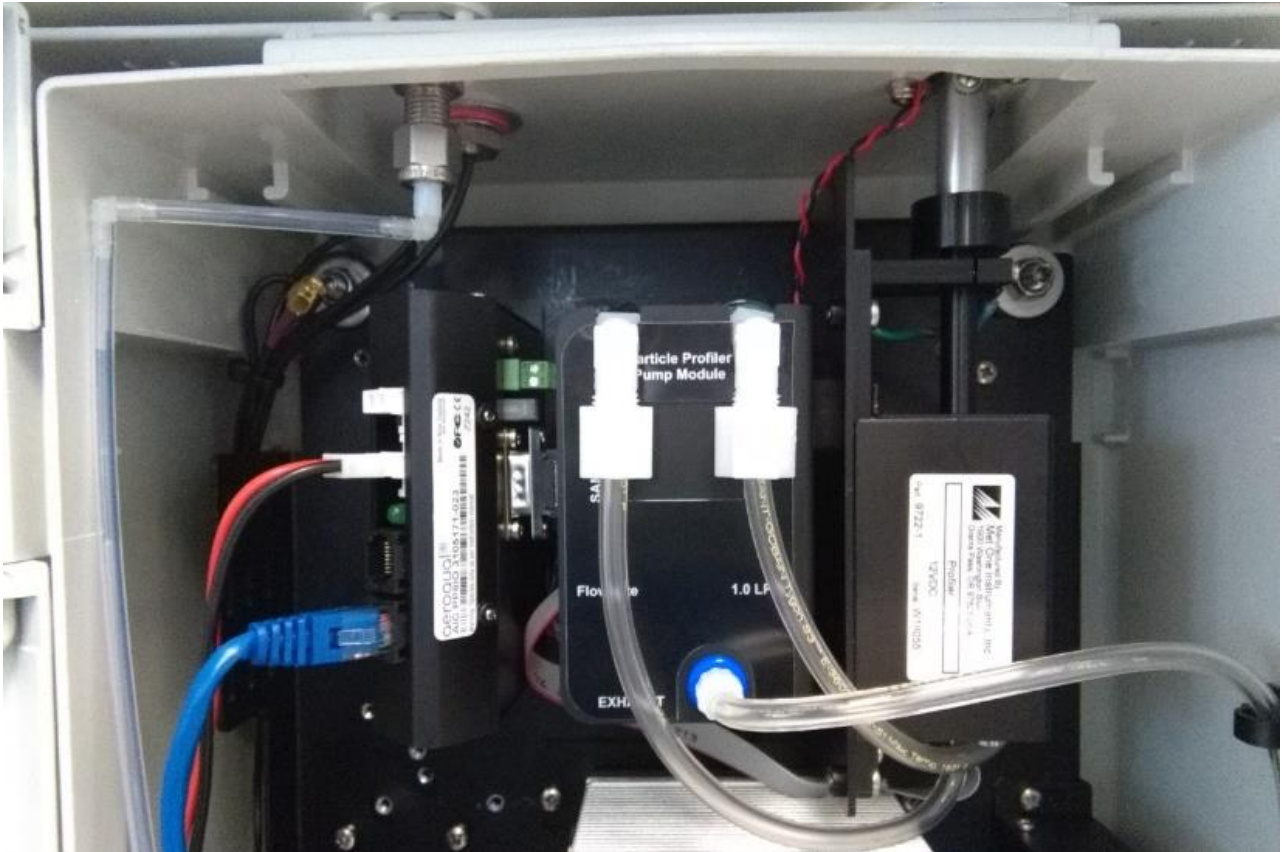

Figure 12-6 The Particle Profiler uses three modules: a) the optical module on the far right, b) the pump module in the middle, c) the electronics module on the left (configuration is subject to change)

12.3 Mains wiring color guide



Caution: The high voltage mains supply must be wired by a certified electrician in compliance with local electrical regulations.

The following table is only intended as a reminder, always check your local guidelines.

Wire	US AC power circuit wiring color codes	UK AC power circuit wiring color codes	IEC (most of Europe) AC power circuit wiring color codes
Live / Phase	Black or Red	Brown or Red	Brown or Black
Neutral	White or Grey	Blue or Black	Blue
Earth / Ground	Green or Green-yellow	Green-yellow	Green-yellow

12.5 Calibration Records

The following records should be used in conjunction with this user guide.

Table 1: Calibration details	
Date Time	
Serial number	
Date of previous calibration	
Customer name	
Site name	
Engineer name	

Table 2: Equipment details		
Equipment	Brand / Model number	Serial number
Gas dilution calibrator:		
Ozone generator		
Zero air source		
Flow meter		
Gas Regulator 1		
Gas Regulator 2		

Table 3: Gas cylinder details					
#	Gas Type	Gas Balance	Manufacturer	Expiry date	Cylinder pressure
1	NO ₂	Air N ₂			
2	Isobutylene	Air N ₂			
3					
4					
5					

Table 4: Site inspection

Check the local surroundings to see if anything has changed which could influence the ongoing ambient gas measurements.

Observations**Table 5: Monitor pre-checks****Before opening the door**

ID	SOP description	Observation / reading	Pass / Fail / Done
5.1	Put monitor into service mode		
5.2	Gas inlet secure		
5.3	Particle inlet secure		
5.4	Door locks are operational		
5.5	Record the flow rate (before opening door)		
5.6	Previously measured flow rate		

After opening the door

5.7	Replace the inlet filters		
5.8	Measure flow rate again		
5.9	Go to section 6 <u>if required</u> then record final inlet flow rate here		

Table 6: Individual module flow rates, leak check manifold and bypass valve

6.1	Check all gas connections	Pass / Fail			
6.2	Leak check sampling manifold	Pass / Fail			
6.5	Flow Rate	Ox / NO₂	O₃	PID	Total module flow
	Flow rate last measured				
	Flow rate measured now				
	If flow rate is the same then pass , if changed then fail	Pass / Fail	Pass / Fail	Pass / Fail	Pass / Fail
6.6	Adjust bypass valve	If all the modules show reduced flow and there is no leak, then the adjustment bypass valve can be used.		Yes / No	
6.7	Flow rate measured following adjustment				
	If flow rate is the same as section 6.3 then pass , if changed then fail .	Pass / Fail	Pass / Fail	Pass / Fail	Pass / Fail
	What was the reason for the change in flow rate?				

Table 7: Zero calibration results

Module	Current offset From monitor settings	Reading after stabilisation 10-minute average	Acceptable reading during zero calibration (ppm) 10 min average	Acceptable standard deviation during zero calibration (10-minute average)	New Calculated offset1	Minimum and Maximum recommended offset (ppm)	Offset uploaded	Reading after offset changed	Pass / Fail
	7.1.1	7.2.3	7.2.3 (b)	7.2.3 (c)	7.2.4	7.2.4 (b)	7.2.5	7.2.6	7.2.7
NO ₂ (Ox module)	0.000				N/A	N/A	N/A	N/A	
NO ₂ (Direct-read)			0.0 0.005	0.002		Max +0.050 Min -0.050			
O ₃			0.0 0.005	0.002		Max +0.050 Min -0.050			
O _x			0.0 0.005	0.002		Max +0.050 Min -0.050			
PID			0.0 0.002	0.002		Max +0.05 Min -0.05			
Comments:									

Equation 4: New offset = Current offset + (AQS gas reading / Gain)

Table 8: Span calibration results

Module	Initial gain	Initial a value	Span point	Reading after stabilisation 10-minute average	Acceptable range during span calibration (ppm) 10-minute average	Maximum acceptable noise during span calibration 10 min std deviation	Maximum Minimum recommended gain	New gain ⁵	New a value ³	Ratio of gain change New gain / Initial gain	Gain uploaded	Reading after gain changed	Pass / Fail
	8.1.1	8.1.2	8.1.3	8.1.5	8.1.5 (b)	8.1.5 (c)	8.1.5 (d)	8.1.6	8.1.6 (b)	8.1.7	8.1.8	8.1.9	8.1.10
NO ₂ (Ox module)	1.000				span ± 5 %	2 % of span	NA	NA		Reading after an adjustment, (should be close to 0.000)			
NO ₂ (Direct-read)					span ± 5 %	2 % of span	max 5.000 min 0.2		N/A				
O ₃		N/A			span ± 5 %	2 % of span	max 5.000 min 0.2		N/A				
O _x		N/A			span ± 5 %	2 % of span	max 5.000 min 0.2		N/A				
PID		N/A			span ± 5 %	2 % of span	max 5.000 min 0.2		N/A				

Comments:

Equation 5: $\text{New Gain} = \text{Current Gain} \times (\text{Span concentration} / \text{Gas reading})$

Equation 3: $a = \text{O}_x \text{ reading} / \text{O}_3 \text{ span concentration}$

NOTE: Ox module adjustments

The O_x module gain adjustment is made during the NO₂ calibration gas delivery

The NO₂ a value adjustment is made during the O₃ gas delivery

The NO₂ gain value is NOT adjusted as part of the calibration process

Table 9: Calibration Post-checks

ID	Description	Observation / reading	Pass / Fail / Done
9.1	Disconnect calibration equipment		
9.2	Record total inlet flow rate		
9.3	Replace the mesh inlet and cap		
9.4	Lock door		
9.5	Secure the site		
9.6	Service mode		

About Aeroqual

Every day, environmental professionals around the world are working hard to protect people and planet from the impact of air pollution. Since 2001 Aeroqual has equipped environmental professionals with technology that takes the time and hassle out of air quality monitoring projects. Government, industry, researchers and environmental consultants trust us to deliver actionable data built on industry-leading sensor technology, wirelessly connected to software in a single integrated package. With thousands of successful projects delivered in 70 different countries on all seven continents, our systems process more than six million air quality measurements per day. In 2017 the U.S. Environmental Protection Agency signed a 5-year R&D collaboration agreement with us to accelerate understanding of air sensor technology.

Just a handful of customers who chose Aeroqual



aeroqual 

Aeroqual Limited

460 Rosebank Road, Avondale, Auckland 1026, New Zealand

T +64 9 623 3013 | e sales@aeroqual.com

aeroqual.com