

All rights reserved. No part of this document may be reproduced, transcribed, translated into any language or transmitted in any form electronic or mechanical for any purpose whatsoever without the prior written consent of **Sentek Pty Ltd.** All intellectual and property rights remain with **Sentek Pty Ltd.**

All information presented is subject to change without notice.

Names of programs and computer systems are registered trademarks of their respective companies.

Ó 1999 - 2009 Sentek Pty Ltd
Diviner 2000 User Guide Version 1.5
All rights reserved

Diviner 2000 is a registered name of Sentek Pty Ltd.

Microsoft Word, Microsoft Excel and Windows Explorer are the trademarks of Microsoft Corporation.

Sentek Pty Ltd
ACN 007 916 672
77 Magill Road
Stepney South Australia 5069
Phone: +61 8 8366 1900
Facsimile: +61 8 8362 8400
Internet: www.sentek.com.au
Email: sentek@sentek.com.au

Rev 1.5 (2009-03-06)

Statements of Compliance

FCC note of compliance and statement of liability

Electro-Magnetic Compliance

This equipment has been tested and found to comply with the limits for a Class B digital device, pursuant to part 15 of the FCC rules. These limits are designed to provide reasonable protection against harmful interference in a residential installation. This equipment generates, uses and can radiate radio frequency energy and, if not installed and used in accordance with the instructions, may cause harmful interference to radio communications. However, there is no guarantee that interference will not occur in a particular installation. If this equipment does cause harmful interference to radio or television reception, which can be determined by turning the equipment off and on, the user is encouraged to try to correct the interference by one or more of the following measures:

- Reorientation or relocation of the receiving antenna.
- Connection of the equipment into an outlet on a circuit different from that to which the receiver is connected.
- Consultation with the dealer or an experienced radio/TV technician.

EMC approvals

The Diviner 2000 soil moisture probe has been tested and found to comply with the following EMC guidelines:

- EN55022:1994(CISPR22:1993) / AS/NZS3548:1995,Amendment 2:1997 Class B
- EN50082-1 : 1992 (IEC 801-2)
(IEC 801-3)
(IEC 801-4)
- FCC Part 15 Class A

Marking

The above EMC approvals allow the product to be marked CE, C-tick and FCC.

Modifications

Any modifications to any part of the equipment or to any peripherals may void the EMC compliance of the equipment.

Radio Interference

The sensor/probe is not to be operated in free air as it may cause interference to radio communication devices.

Contents

Introduction.....	1
About this user guide	1
Document conventions.....	1
About Diviner 2000	2
Data use	3
Installation/calibration recommendations.....	3
Care and Maintenance of the equipment	4
Storing the Diviner 2000.....	5
Part 1—The Diviner 2000 display unit and probe	6
General description.....	6
The display unit	6
Connection panel	7
The probe.....	7
Before you start	8
Charging the Diviner 2000 display unit	8
Starting the Diviner 2000.....	8
Status screen	9
Connecting the probe to the unit	9
Setup mode	10
Setting the time and date.....	11
Normalizing the sensor	12
Adjusting the vertical scale units (inch, cm).....	13
Setting the default screen	13
Adjusting the LCD contrast	13
Adjusting the serial baud rate.....	14
Calibrating Diviner 2000	14
What is the calibration equation?	14
Working with the default calibration equation	15
Creating a soil profile with the default calibration equation	16
Working with customized calibration equations.....	18
Measuring the soil moisture content.....	19
Scan mode	19
Continuous mode	21
Accessing Diviner 2000 data	22
Table mode (single and summed)	22

Contents

Graphs (single and summed).....	24
Deleting data.....	27
Formatting the Diviner 2000.....	28
Enabling the unit configuration menu item	28
Irrigation scheduling using Diviner 2000 data.....	29
Why monitoring soil moisture for irrigation scheduling?	29
Plotting data on your Irrigation Management Chart	30
Other basic records required for irrigation management.....	31
How often should I take readings?	33
Important soil water phases for irrigation scheduling.....	33
Examples of data and trend interpretation	36
Constructing site specific soil water budgets.....	45
Part 2 Diviner 2000 Utilities software	47
Before you begin	47
Using online help.....	47
Using Diviner 2000 Utilities	47
Installing Diviner 2000 Utilities.....	48
Starting Diviner 2000 Utilities	49
The Diviner 2000 Utilities main window	49
Establishing communications.....	50
Backing up Diviner 2000 data.....	52
Restoring and Exporting data.....	53
Using ESW ID Tags	57
Troubleshooting	60
Recommended reading	63
Appendix A—Theory of Operation.....	64
Appendix B—Soil Moisture Management.....	66
Appendix C—Creating a customized calibration equation	69
Appendix D—Software License Agreement	73
Index	81

List of Figures

Figure 1— Components of the Diviner 2000 display unit and probe.....	2
Figure 1a — Dust cap removal from probe cable.....	4
Figure 1b — Sensor head, water sensing screws.....	5
Figure 2—Diviner 2000 display unit.....	6
Figure 3—Connection Panel.....	7
Figure 4—Status screen.....	9
Figure 5—Setup screen.....	11
Figure 7—Calibration screen.....	16
Figure 8—Scan screen.....	19
Figure 9—Continuous screen.....	21
Figure 10—Table mode.....	22
Figure 11—Single graph screen.....	25
Figure 12—To show dashed vertical line.....	26
Figure 13—Summed graph screen.....	26
Figure 14—Irrigation management chart.....	32
Figure 15—To show trends with continuous, frequent and infrequent data collection.....	33
Figure 16—Soil water extraction phases.....	34
Figure 17—Daily Water changes.....	37
Figure 18—The active root zone.....	38
Figure 19—Onset of crop water stress.....	39
Figure 20—Root zone water extraction.....	40
Figure 21—Irrigating beyond the root zone (over-irrigation).....	41
Figure 22—Depth of irrigation balances soil moisture extraction.....	42
Figure 23—Full point in summed graph.....	43
Figure 24—Water-logging.....	44
Figure 25—Rising water tables.....	45
Figure 26—Soil Water Budget trends.....	46

Introduction

About this user guide

This user guide describes the Diviner 2000 display unit and probe and associated software in two parts. **Part 1** describes how to use the Diviner 2000 display unit and the probe; **Part 2** describes the Diviner 2000 Software Utilities. The Appendices contain technical information and software licenses.

Document conventions

These document conventions have been used in this guide.

Conventions	Type of information
Arrow bullet (Ø)	Indicates a step-by-step procedure to follow—e.g. 'To take a reading'
Bold text	Used to highlight an emphasized word, for example, ' Note:... ' or Warning
<i>This font face</i>	Used for the names of modes and software commands e.g. Setup mode and screen display messages.
DELETE	Screen and key names are reproduced as they appear on the Diviner 2000 display unit and its LCD display
Up and down arrow keys	Used to select an item in the menu on the LCD
Left and right arrow keys	Used to cycle through the options in menu item
Note:	Gives additional information
Warning:	Indicates a danger to personnel
<i>Caution:</i>	Indicates that failure to observe the correct procedure could result in damage to equipment or misleading data

About Diviner 2000

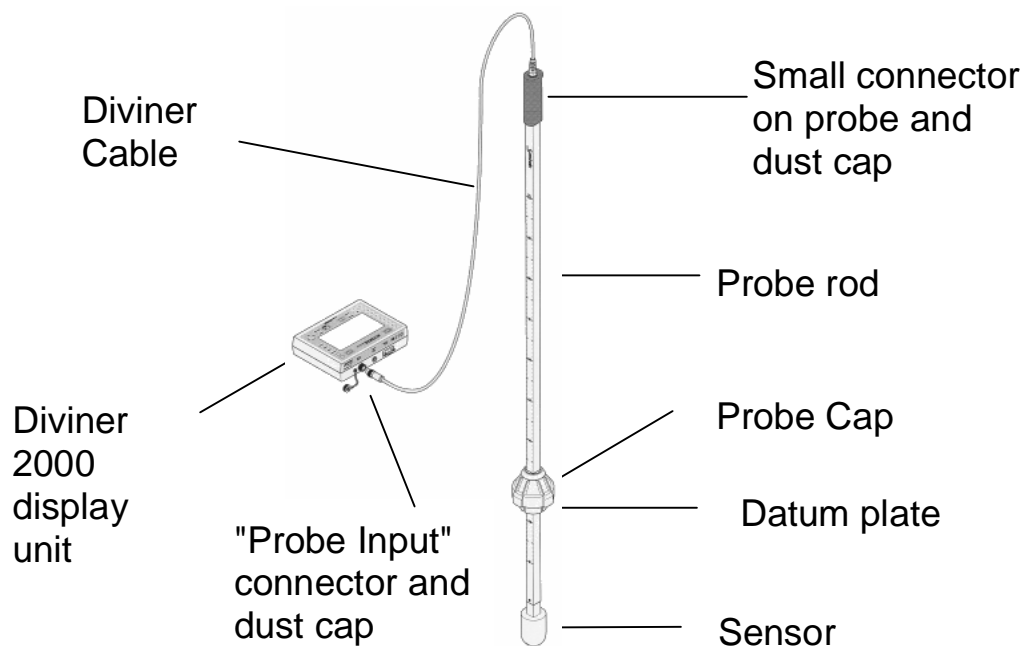

Figure 1— Components of the Diviner 2000 display unit and probe

Diviner 2000 is a portable soil moisture monitoring system. It comprises a data display unit and a portable probe.

The portable probe measures soil moisture content at regular intervals of 10 cm (4 inches) down through the soil profile. Readings are taken through the wall of a PVC access tube. Data is collected from a network of access tubes installed in selected sites.

There is no need to stop, pause and hold the probe at a particular depth while you take a reading. In one *swipe and go* action, Diviner 2000 records data from all levels in the soil profile to the depth of the probe, i.e. 0.7 meters, 1 meter or 1.6 meters (28 inches, 40 inches or 65 inches).

Each reading is a snapshot of the soil moisture content at a specific depth in a particular soil profile. The more frequent the readings are taken, the more complete the soil moisture data. Sentek recommends that all sites are read at least once every 24 hours.

A series of readings may be:

- interpreted in the field using the display unit
- downloaded to your PC using Diviner 2000 Utilities
- displayed on the Irrigation Management Chart.

A series of readings shows trends in water use in the soil profile that mirrors the speed and depth at which crop water use occurs. The readings show how quickly, and where, the plant is removing water from the soil.

You can estimate the extent of the living root zone of a plant and visualize the actual depth of an irrigation or rainfall event.

Since the Diviner 2000 display unit automatically displays the ten most recent soil moisture readings for the one site, you can easily identify soil moisture trends. However, data recorded with the Diviner 2000 display unit can be downloaded to your PC for backup farm record maintenance.

Data use

The Diviner 2000 display unit, the probe, the installed access tubes and the Diviner 2000 Utilities software combine to give you meaningful data on soil moisture and:

- daily crop water use
- extraction patterns from different layers of a soil profile
- depth and distribution of the root zone
- depth, distribution and effectiveness of the 'wetting front' after an irrigation or rainfall event
- changes in soil texture and/or structure
- use of crop water use in stressed and/or non-stressed crops
- onset of crop water stress
- crop water use changes, e.g. the effects of different crops, varieties, ages, canopy sizes, fruit loads, irrigation system performances, soil types, topographical exposure, disease incidents, cultural management practices, soil salinity changes, soil structural problems, weather conditions and many other factors
- crop water use under water logged conditions
- occurrence and impact of water tables on the soil profile and the crops root zone
- changes of the shape of the 'wetting onion' in drip irrigation
- site specific budgets for optimal crop productivity and irrigation efficiency. With these budgets you can predict the next irrigation date and the necessary amount of irrigation to refill the profile.

Some of this information requires expert advice. This user guide will get you started.

Review the Diviner 2000 video, which came as part of your package. It shows the portability of the display unit and probe and illustrates the 'swipe and go' technique used for collecting data.

Installation/calibration recommendations

Sentek recommends that trained distributors or agronomists set up and configure your Diviner 2000 system. Their experience and training should

Introduction

Care and Maintenance of the equipment

ensure accurate site selection, which with good access tube installation will provide you with meaningful soil moisture data.

Care and Maintenance of the equipment

- Contact your Sentek distributor when repairs or maintenance are needed on the Diviner 2000 equipment. Do not attempt repairs yourself. This can result in further damage being caused to the equipment and will void any Sentek warranty.
- Keep all equipment clean and dry.
- Put equipment in the protective cases when it is not in use or is being transported.
- Secure equipment for transportation to the field.
- Disconnect Diviner cable from the Display Unit and from the Probe before transportation
- Always cover connectors with the supplied dust caps when cables are not connected.
- The probe cable dust cap is held in place with interlock fingers. To remove the dust cap slide (pull back) the connector sleeve toward the cable then withdraw the cap. Force is not required to remove the cap. You must align the red dots to replace the cap. The same technique is required to remove the cable connector from the probe handle.

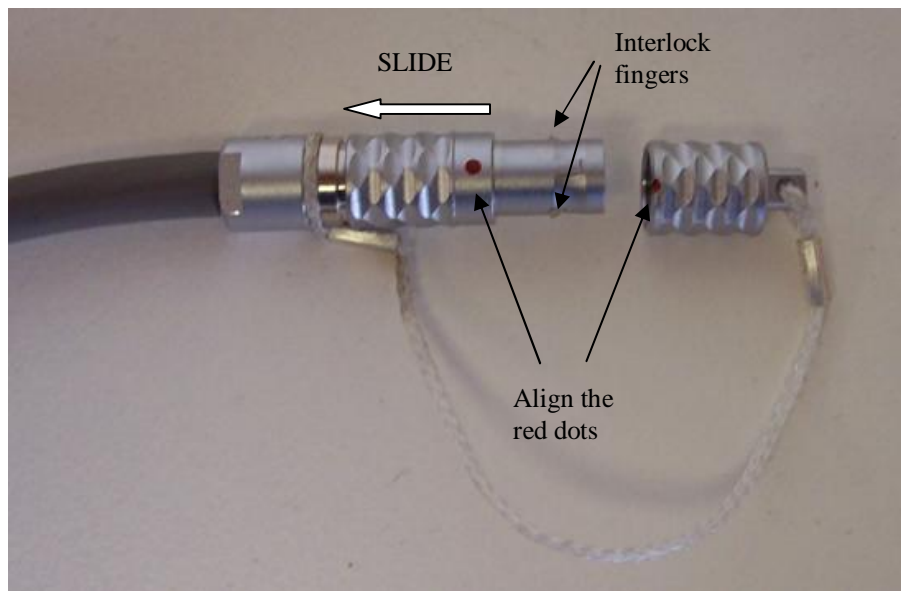

Figure 1a — Dust cap removal from probe cable

- The screws located at the bottom of the sensor head do not provide access into the sensor. These screws are sensors that detect when there is water in the access tube.

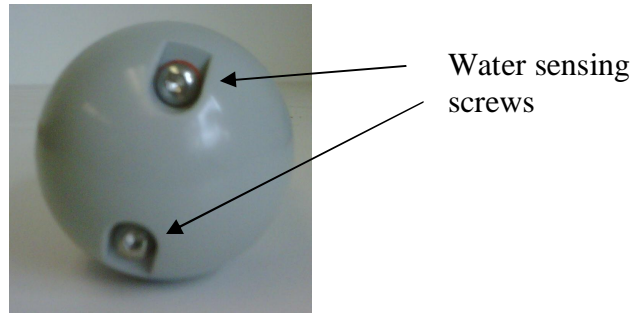

Figure 1b — Sensor head, water sensing screws

Storing the Diviner 2000

The following recommendations should be followed when storing the Diviner 2000 display unit to maintain a high battery life:

- Charge the unit thoroughly prior to storage.
- Recharge the unit monthly to prevent total discharge of the battery. Repeat the charging if full charge is not achieved after the first cycle.
- Fully charge the Diviner 2000 display unit prior to the first use after storage.

Part 1—The Diviner 2000 display unit and probe

General description

The Diviner 2000 display unit is a data storage, display and conversion tool. It collects and stores information for up to 99 profiles or soil monitoring sites.

The display unit

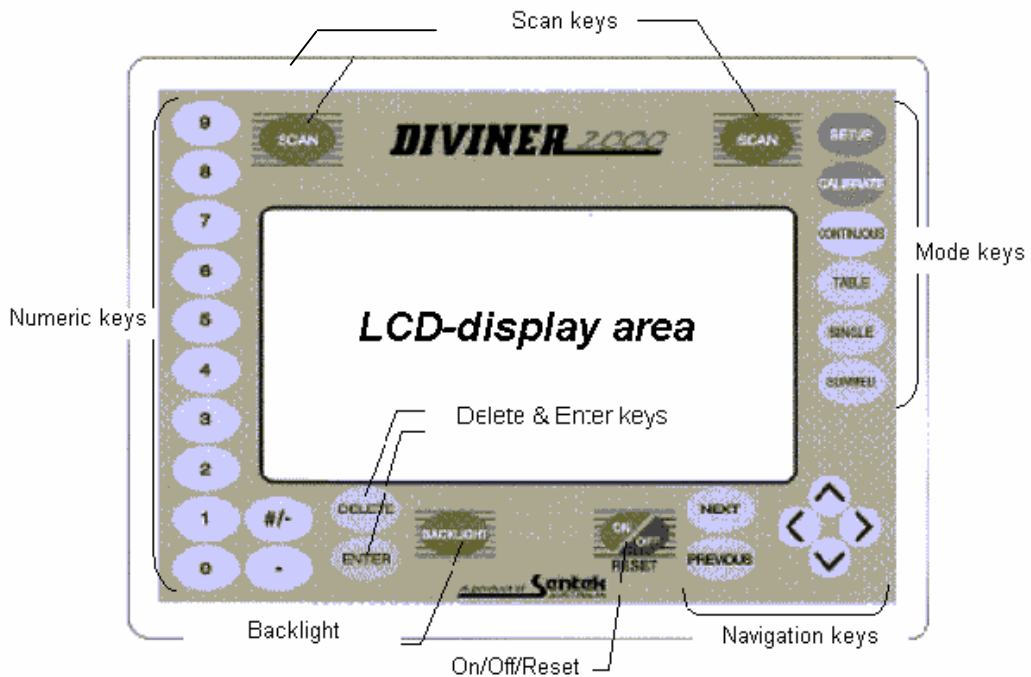

Figure 2—Diviner 2000 display unit

The display unit has a screen surrounded by a keypad.

The keypad has four types of press buttons or keys:

Key type	Example	Description
Function	ENTER, DELETE, SCAN	Allows you to: <ul style="list-style-type: none"> • enter information • delete information • enter <i>scan mode</i> .
Navigation	< >, PREVIOUS	Allows you to: <ul style="list-style-type: none"> • move between screens • select options.

Key type	Example	Description
Mode	SETUP, CALIBRATE, SUMMED	Access to data setup and manipulation
Numeric	1, 2, ...	Use to create profiles and calibrate probes

Connection panel

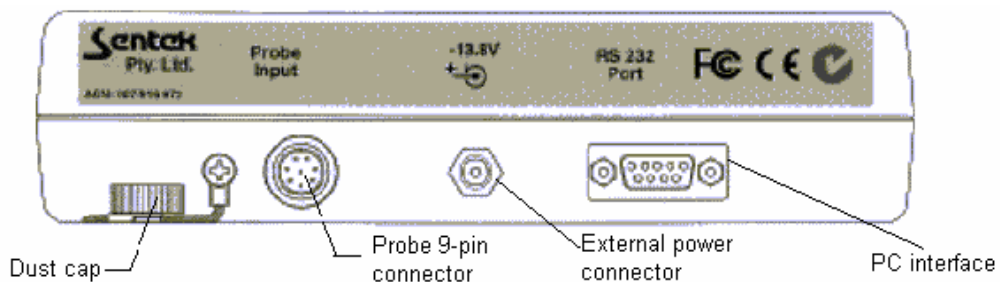

Figure 3—Connection Panel

The connection panel is on the top of the display unit. There are connectors for the probe cable, External power connector for power pack and serial cable. Each connector is labeled and comes with a protective cover (dust cap)— only the probe connector cover is illustrated.

The probe

The Probe consists of a metal rod with a probe cap and a sensor at the bottom. The connection cable from the Diviner 2000 display unit plugs in to the connector at the top end of the rod.

Probes are supplied in three scanning lengths, 0.7 meters (28 inches), 1 meter (40 inches) and 1.6 meters (65 inches). Markings on the rod, when they are aligned with the top of the probe cap, show the depth of sensor insertion below the soil surface. On one side markings are in centimeters; on the other in inches.

The probe collects readings automatically at 10 cm depth intervals. A 0.7 meter (28 inches) probe therefore collects readings from 7 depth levels, the 1.0 meter probe from 10 depth levels and the 1.6 meter probe 16 depth levels.

Before you start

Charging the Diviner 2000 display unit

The Diviner 2000 display unit requires charging.

A 13.8V DC, 800 mA regulated power pack is supplied by Sentek Pty Ltd. Alternatively a 15V Universal (100-250V) AC Adaptor is supplied.

Always charge the Diviner 2000 display unit before and after use.

Ø To charge the Diviner 2000 display unit

1. Turn on the Diviner 2000 display unit.
2. Connect the power pack to the Diviner 2000 display unit
3. Verify that the prompt 'Charging' is displayed.
4. Turn off the Diviner 2000 display unit and leave to charge.
The Diviner 2000 display unit is fully charged when 'charging' stops flashing (Maximum charge time = 4 hours).
5. Disconnect the power pack.

Starting the Diviner 2000

Ø To turn on the Diviner 2000 display unit

Press the **ON/OFF/RESET** key quickly and firmly. Initialization begins and the *Status* screen displays.

Status screen

The *Status* screen is displayed when the Diviner 2000 display unit is turned on. It is a summary screen describing the current status.

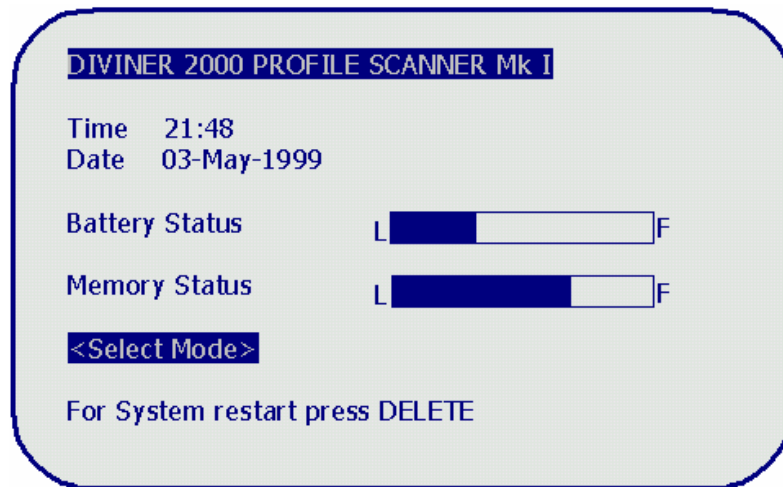

Figure 4—Status screen

feature...	means...
Time	current time
Date	current date
Battery status	<p>when the display unit is not connected to an external power source the <i>Battery status</i> displays the current battery charge level.</p> <p>When the display unit is connected to the charger, the <i>Battery status</i> flashes the word 'charging'.</p>
Memory status	<p>the memory status displays how much memory has been used and how much memory remains. Each time readings are taken they are entered into the Diviner 2000 memory. The unit stores up to 990 readings. A full memory is indicated by a black bar. The oldest readings are deleted as new ones are recorded.</p>

Connecting the probe to the unit

Ø To connect the probe to the Diviner 2000 display unit

1. Remove the dust cap from the "Probe Input" connector on the Display Unit.

Part 1—The Diviner 2000 display unit and probe

Setup mode

2. Align the large connector on the probe cable with "Probe Input" connector.
Note: It will only fit one way.
3. Insert and screw together to form secure connection.
4. Remove the dust caps from the small connector at the top of the probe and the small connector on the probe cable. See page 4.
5. Align the red marking on the small connector with the red mark on the probe connector and push them together.

Note: The small connector does not need to be screwed in and will only fit one way.

The Diviner 2000 display unit is now connected to the probe.
You are now ready for setting up Diviner 2000.

Setup mode

Setup mode is used to configure the Diviner 2000 display unit.

From the *Setup* screen you can:

- reset the time and date
- take air and water raw counts for probe normalization
- adjust the vertical scale (cm or inches)
- set the default screen for data presentation (none, single table, summed table, single graph, summed graph).

Note: After completing a scan, the **Diviner 2000** display unit automatically displays the data on the chosen default screen.

- adjust the LCD contrast.
- set the serial baud rate to the rate of the computer's communication port.

- ∅ To enter Setup mode
 1. From any screen, press **SETUP**.
The *Setup* screen displays.

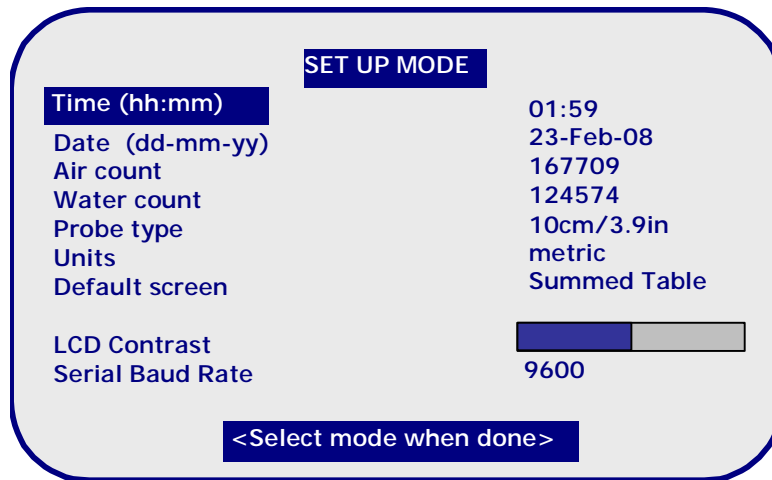

Figure 5—Setup screen

Setting the time and date

Diviner 2000 uses a 24-hour clock. The time and date settings indicate when a reading is taken in the field and forms part of the profile reading record.

- ∅ To set the time
 1. Use the arrow keys to move the cursor to the **Time** field.
The *Time* function is highlighted.
 2. Enter the current four-digit time using the numeric keypad, e.g. 2219 for 10:19 pm.
The time separator is added automatically.
 3. Press **ENTER** to save the new time setting.
The cursor moves to the date setting.

- ∅ To set the date
 1. Use the arrow keys to move the cursor to the **Date** field.
The *Date* function is highlighted.
 2. Enter the current two-digit day using the numeric keypad, e.g. 18.
 3. Press **NEXT** or **PREVIOUS** to select the month, e.g. May, June.
 4. Use the arrow keys to move the cursor to the year.

Part 1—The Diviner 2000 display unit and probe

Setup mode

5. Enter the last two digits of the year using the numeric keypad, e.g. 99 or 00.
6. Press **ENTER** to save the new date setting.
The cursor moves to the air count setting to begin normalizing the probe.

Normalizing the sensor

The sensor is normalized using a special normalization tube to set the air and water counts. This is necessary because each sensor responds slightly differently to air and water. By entering these counts into the equation as described in Appendix A, it is possible to standardize all sensor readings, i.e. readings taken by different sensors become comparable.

This results in meaningful data and flexibility in the use of probes.

∅ To set the air count

1. Use the arrow keys to move the cursor to the **Air Count** field.
The *Air count* function is highlighted.
2. Place the probe inside the sealed normalization tube.
3. Hold the probe and normalization tube in the air, clear of all solid objects.
4. Press **ENTER**.

Note: The reading is taken over a 10-second interval and the probe must be held in the air for this period.

5. If 'failed' is displayed on the screen, repeat the air count, steps 3 and 4.

∅ To set the water count

1. Use the arrow keys to move the cursor to the **Water Count** field.
The *Water count* function is highlighted.
2. Press **ENTER** at prompt.
3. Insert the probe into the sealed normalization tube.
4. Place the tube and probe into a 10 litre water-filled bucket.
Note: Make sure that there is at least 10 cm (4 inches) above the top, below the bottom and on each side of the probe.
5. Wait until the measurement is complete.
6. Repeat if an error message appears.

Caution

Sensor head should not be placed directly in water. Always use the sensor inside an access tube.

Adjusting the vertical scale units (inch, cm)

Note: the Probe Type field cannot be changed. It is always 10cm/3.9 inch. The type of Units can be changed at any time as the data is store in independent units.

∅ To adjust the vertical scale units

1. Decide on your preferred setting of Imperial (inches) or metric (centimeters) .
2. Use the up/down arrow keys to move the cursor to the **Units** field.
3. Use the left/right arrow keys to toggle between the metric and imperial options.
4. Press **ENTER** to save or use the up/down arrow keys to move on to the next option.

Setting the default screen

This option selects which graph type is displayed after a scan is performed.

∅ To adjust the default screen

1. Use the up/down arrow keys to move the cursor to **Default screen** field.
The *Default screen* function is highlighted.
2. Use the left/right arrow keys to select from the available options; table, single or summed, (refer to page 22).
Note: Sentek recommends that you set the ‘summed’ graph as the default screen.
3. If you select **None** the unit will stay in *Scan mode* after completing a scan.

Adjusting the LCD contrast

Note: The **BACKLIGHT** button may enhance the readability in low light conditions.

Ø To adjust the LCD contrast

1. Use the up/down arrow keys to move the cursor to the **LCD contrast** field.
The *LCD Contrast* function is highlighted.
2. Use the left/right arrow keys to adjust the **Screen contrast** for optimal viewing, indoors or outdoors.
3. Press **ENTER** to save or use the arrow keys to move on to the next option.

Adjusting the serial baud rate

Ø To adjust the serial baud rate

- Use the arrow keys to move the cursor to the **Serial Baud rate** field.
The *Serial Baud rate* function is highlighted.
4. Use the arrow keys to adjust the rate to the desired connection speed for interfacing with your PC.
 5. Press **ENTER** to save or use the arrow keys to move on to the next option.

Calibrating Diviner 2000

Before you begin to use Diviner 2000 you must enter a calibration equation. Diviner 2000 does not automatically generate accurate volumetric soil water content data for all types of soils. To obtain this information you need to calibrate Diviner 2000

You calibrate by using either the default calibration equation supplied by Sentek Pty Ltd or deriving your own customized calibration equation. The Sentek Pty Ltd supplied equation gives ‘relative data’; your own calibration equation gives ‘absolute data’. For most users ‘relative data’ is sufficient.

What is the calibration equation?

A calibration equation is a mathematical relationship between Diviner 2000 scaled frequency readings and real volumetric soil water content. It is determined by Gravimetric Sampling, refer to Appendix C. This mathematical relationship is described by an equation which has ‘A’, ‘B’ and ‘C’ values. An example is shown in Figure 6.

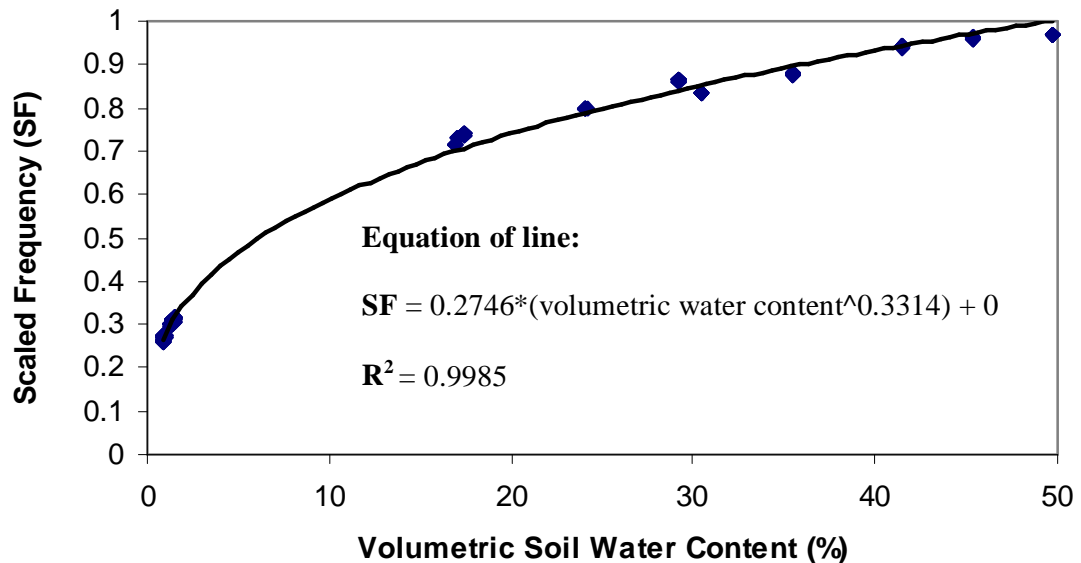

Figure 6—Diviner 2000 calibration equation for combined soil textures

Working with the default calibration equation

The default calibration equation is based on combined data gathered from sampling on sand, sandy loam and an organic potting soil. It is described in Figure 6. It is built into the Diviner 2000 display unit and is labeled as the calibration equation for soil type #01.

If you chose to work with the default calibration equation, the data will show relative soil water changes in all soil types except for those on which the equation is based. In these soil types, the data will show absolute values.

Relative data

Most users use this form of measurement because they are interested in the relative changes in soil water dynamics for their daily irrigation management practices.

This concept was introduced successfully with EnviroSCAN, Sentek Pty Ltd's continuous monitoring system. Almost all economic gains recorded with EnviroSCAN in commercial agriculture were made using the concept of 'relative change' in soil water dynamics.

Based on this experience, Sentek Pty Ltd recommends that relative changes in volumetric soil moisture content based on the default calibration supplied, can be used to show the most important soil water trends.

EnviroSCAN	Diviner	Cook ≈ Raw
A = 0.1957	A = 0.2746	-1000.0
B = 0.404	B = 0.3314	1.0
C = 0.02852	C = 0.0	1.0
		High = 1
		Low = 0
		e.g. Raw = 19700
		Cook = 19.700

Creating a soil profile with the default calibration equation

Ø To enter CALIBRATION mode

1. Press **CALIBRATE**.

The *Calibration Mode* screen displays. The units will be displayed in imperial (inches) or metric (cm).

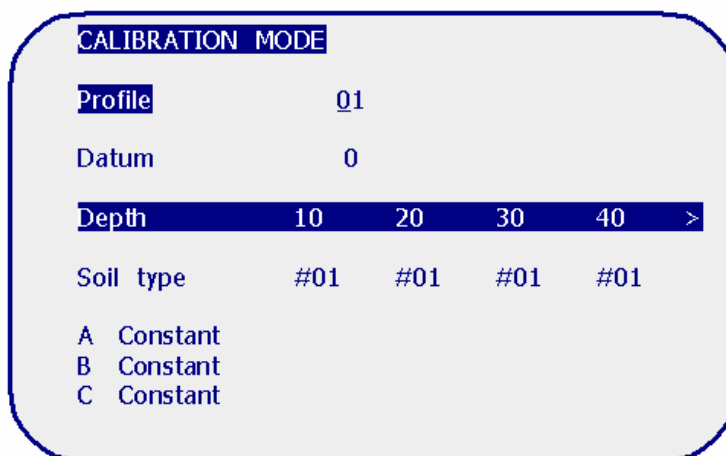

Figure 7—Calibration screen

feature...	means...
Profile	soil profile ID number
Datum	The Datum is the reference point for sampling depths. It is the bottom lip (datum plate) of the access tube top cap. When the Diviner probe is screwed into the top cap it is automatically aligned with the datum plate.

feature...**means...**

During installation of the access tube the top cap lip is generally flush with the soil surface. Alternatively the lip can be positioned 5 cm/2 inch above the soil surface. This allows the Diviner 2000 sample to be taken at 5 cm/2 inch below the soil surface rather than 10 cm/3.9 inch. This can be useful for shallow rooted crops.

The Diviner 2000 Datum value should match the alignment of the access tube top cap Datum plate.

Set Diviner Datum value to:

- 0.0 cm when Access tube top cap is flush with soil surface.
- 5.0 cm/2 inch when Access tube top cap is 5 cm/2 inch above soil surface.

Soil type

Diviner 2000 allows you to record up to 99 different soil types. Your site details may be entered using the storage locations '01' to '99'. The '#' symbol is used for default options.

Constant

'A', 'B' and 'C' values

Ø To create a soil profile (See page 28 to delete a profile)

1. Use the arrow keys to highlight **Profile**.
2. Use **NEXT** and **PREVIOUS** to navigate through the different site profiles or, use the *numeric key pad* to type in the site profile identification number.
3. Press **ENTER** to go directly to a particular site profile.
4. Use the down arrow key to highlight **Datum**.
If the top cap is flush with the soil surface, leave the Datum value at 0.0.
If the top cap datum plate is 5 cm/ 2inch above the soil surface, set the Datum value to 5.0 cm /2.0 inch using the *numeric key pad* and pressing 5 (or 2).

Working with customized calibration equations

Absolute data

To generate absolute data, you need to conduct gravimetric sampling to calibrate the Diviner 2000 for every soil textural layer on your property.

Sentek Pty Ltd recommends that the Gravimetric sampling technique is used. It is recognized as the world standard and has been used to calibrate devices such as the Neutron Probe and TDR. (Refer to Appendix C).

The probe is calibrated by plotting scaled frequency against independently determined soil water values expressed as volumetric soil moisture content in percentage.

The relationship between scaled frequency and independently determined volumetric soil moisture content values provide the calibration curve. This relationship can be a straight line or curve and is described mathematically by the calibration equation.

Creating a soil profile using customized calibration equations

∅ To enter Calibration mode

1. Press **CALIBRATE**.
The *Calibration Mode* screen displays.

∅ To create a soil profile

1. Use the arrow keys to highlight **Profile**.
2. Use **NEXT** and **PREVIOUS** to navigate through the different site profiles.
3. Or, use the *numeric key pad* to type in the site profile identification number.
4. Press **ENTER** to go directly to a particular site profile.
5. Use the down arrow key to highlight **Datum**.
If the top cap is flush with the soil surface, leave the Datum value at 0.0.
If the top cap datum plate is 5 cm/ 2inch above the soil surface, set the Datum value to 5.0 cm /2.0 inch using the *numeric key pad* and pressing 5 (or 2).
6. Use the *arrow keys* to select **Soil Type**.

7. Enter the soil type number using the *numeric key pad*.
The '**A Constant**' is highlighted.
8. Use the *numeric key pad* to enter a value.
9. Press **ENTER**.
10. Repeat for constants '**B**' and '**C**'.
11. Use the *arrow keys* to move across to different depths.
Note: A soil type once entered, cannot be modified or deleted using the **DELETE** key. A soil type, i.e. #01..., is deleted when it is not used by any stored profile.
The probe length is set when the first measurement is made.

Measuring the soil moisture content

When your access tubes have been installed, you are ready to use the **Diviner 2000** to measure soil moisture content. Refer to the Access Tube Installation Guide or your local distributor for details on how to install your access tubes.

You use one of two modes to record the soil moisture data:

- scan—automatically takes readings at 10 cm intervals and the data is recorded by the display unit
- continuous—reading at any depth but the recording is manual so you need to write down the readings.

Scan mode

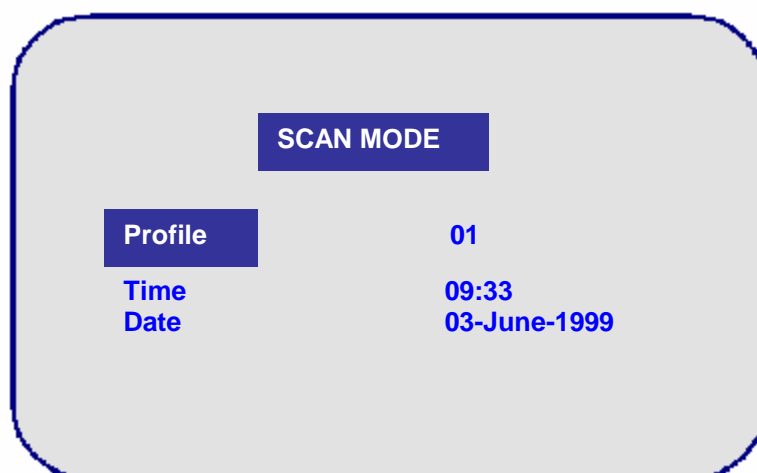

Figure 8—Scan screen

Part 1—The Diviner 2000 display unit and probe

Measuring the soil moisture content

Ø To scan (swipe and go)

Note: The first 'swipe and go' at each profile determines the maximum depth for future readings.

1. Unscrew the cap on the access tube.
2. Insert the probe.
3. Align the two lugs on the access tube top cap base with the gap in the Diviner 2000 datum plate.
4. Screw down the probe cap to the top of the access tube.
5. On the display unit, press **SCAN**.
The selected soil profile, time and date appear on the top of the screen.
6. Verify that the soil profile is correct. (Refer to your Soil Profile booklet if necessary.)
7. Press **ENTER**.
The prompt '*Position the probe at start point*' appears.
8. Position the probe at start point.
Note: Start point is at the top of the access tube not the bottom.
The prompt '*Insert probe*' appears.
9. Insert the probe at a constant rate to the depth of the profile.
The display unit will 'beep' as it takes a reading at each 10 cm (4 in) interval.
Note: If there is water in the bottom of the access tube an alarm sounds and the following message displays:
*'Warning:
Water in tube.
Turn off and rectify'*.
Dry the access tube and sensor head before taking any more readings.
10. Remove the probe at the same constant rate.
When readings have been recorded for each depth the display unit displays the following two messages indicating a successful scan:
 - '*logging data*'
 - '*scan completed*'.
11. If a reading was missed during the scanning process, the following message appears:
 - '*Scan failed*'.**Note:** '*Scan failed*' will also appear if the reading is outside of the water-air calibrated range or the probe length is longer than the probe being used (see delete profile on page 28).

12. Press **ENTER** to try again or **DELETE** to exit.

The readings are displayed in the default screen that you selected during setup, i.e. in a summed or single, table or graph. You can view the readings in any of the four forms by pressing the **TABLE**, **SINGLE** or **SUMMED** mode keys.

Continuous mode

Continuous mode allows you to take readings continuously at a manually selected depth.



Figure 9—Continuous screen

∅ To access continuous mode

1. Press the **CONTINUOUS** mode key.

Note: <CONT> is used as the on-screen abbreviation for the **CONTINUOUS** mode key.

The time and date display in the upper portion of the screen.

feature...	means...
Profile	the site profile being viewed
Depth	the vertical depth to which the soil moisture content reading refers (single table), or the total moisture content down to that depth (summed table)
Soil type	the calibration equation reference number

2. Press **CONTINUOUS** again to begin to display the soil moisture content at the chosen depth.

Raw count, the SF, and the water content are now added to the screen

display

feature...	means...
RAW COUNT	raw frequency count, read from the probe
SF	scaled frequency
WATER CONTENT	volumetric water content (mm/10 cm)

- To stop recording, press **CONTINUOUS** or select another mode.

Accessing Diviner 2000 data

This section describes the data available on the Diviner 2000 display unit through the table mode, single and summed, and single graph and summed graph modes. If you interpret the data in the field, then you can take steps immediately to schedule irrigation.

Table mode (single and summed)

Information displayed in this mode may be single or summed. The display depends on your selection of either **Single** or **Summed** in the feature options.

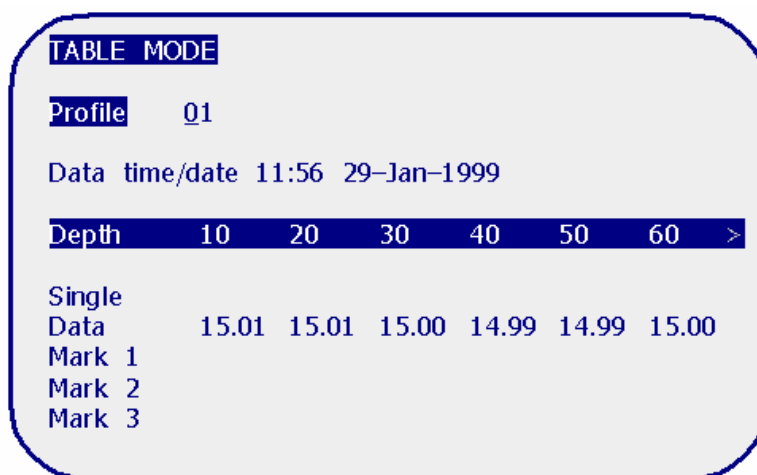

Figure 10—Table mode

- To use Table mode
 - Press the **TABLE** mode key. In this mode the following is displayed:

feature...	means...
Profile	site profile being viewed

feature...	means...
Data time/date	time and date of data recorded
Depth	depth to which the soil moisture content reading refers (single table), or the total moisture content down to that depth (summed table)
Single or Summed	type of data display: <ul style="list-style-type: none"> • In single table the data values represent the soil moisture content at each 10 cm (4 in) depth interval. • In summed table the data values represent the cumulative soil water content, i.e. the value below 30 cm (12 in) equals the sum of the water content measured at 10 cm (4 in) + 20 cm (8 in) + 30 cm (12 in). e.g. 0-30cm, 0-100cm
Data	soil moisture content values (single = mm/10 cm; summed = mm/depth range)
<i>In single mode only</i>	
Mark 1 - 3	soil moisture levels of interest
<i>In summed mode only</i>	
Full	soil moisture level set as an upper point for irrigation
Refill	soil moisture level set as a re-irrigation point a little above the 'onset of crop water stress'
Marker	highlights soil moisture levels of interest

∅ To enter table mode (Summed)

5. Use the up/down arrow keys to select **Data**.

6. Press **NEXT**.

The *Table* mode (Summed) screen displays.

Note: Additional screen items display in the *Table* mode (Summed) screen.

∅ To return to table mode (Single) from table mode (Summed)

1. Use the arrow keys to select **Data**.

2. Press **PREVIOUS**.
The *Table* mode (Single) screen displays.
- Ø To set the Full, Refill and Mark points in summed table mode
1. Select **Profile** and change if required by:
 - using the **NEXT** and **PREVIOUS** keys or
 - typing the soil profile ID number using *the numeric key pad*.
 2. Select **Data time/date**.
 3. Use the **NEXT** and **PREVIOUS** keys to scroll through each data set recorded.
 4. Use the arrow key to scroll across the depth intervals and highlight **Data, Full, Refill** or **Marker**.
When **Full** is highlighted, you can enter a full point for each individual depth using a combination of the number and arrow keys.
 5. Press **ENTER** after typing the desired value.
 6. If you make a mistake, use the **DELETE** key to clear the last character entered.
 7. Use steps 7–9 to alter/enter **Refill** and **Marker** points.
 8. Select another mode.
- Note:** The default depth for the single and summed graph can be set in *Table mode*.
9. Select the desired depth and press **ENTER**.
From now on this depth will be displayed when you access single or summed graph.

Graphs (single and summed)

Like the table presentation, graphs can be viewed in single and summed formats. However rather than working in a single mode with a toggle between single and summed, you use two modes which are accessed through **SINGLE** and **SUMMED** mode keys. *Single mode* allows you to view the soil moisture content at a particular depth over time; *summed mode*, the changes in total soil moisture content over time.

Single mode

In *Single mode* the data displayed relates to a single depth on the soil profile.

Note: **SINGLE** appears at the top of the screen.

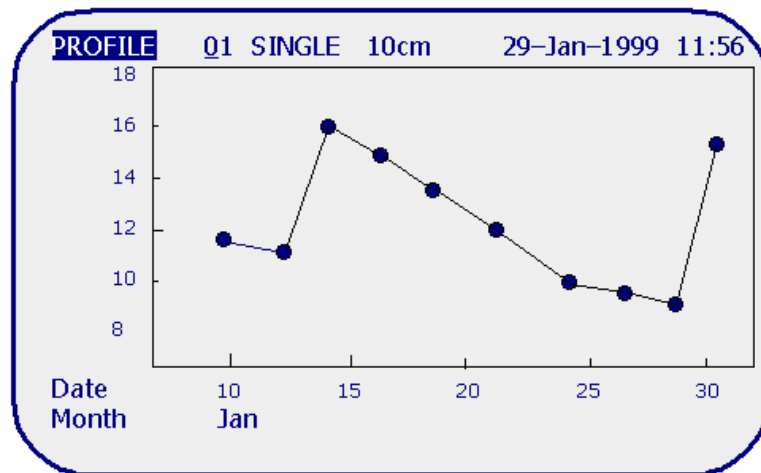

Figure 11—Single graph screen

∅ To use the single graph mode

1. Press the **SINGLE** mode key.

The date and time of data recording displays in the top right hand corner.

In this mode:

feature...	means...
PROFILE	current site for which data is being displayed
SINGLE	screen display is a single graph depicting the soil moisture content at the displayed depth (cm or inches)
# e.g. 10 cm	number next to SINGLE indicates the depth of the reading
y-axis	soil moisture content (mm/...)
x-axis	date (and month)

2. Use the arrow keys to move between **PROFILE** and **SINGLE**.
Note: When the screen first appears **PROFILE** will be highlighted.
3. To view another site profile:
 - type in the profile ID number using *the numeric key pad* or
 - use the **NEXT** and **PREVIOUS** to scroll through the site profiles.
4. To change the depth:
 - select **SINGLE**
 - use the **NEXT** and **PREVIOUS** keys.
5. To obtain exact soil moisture content values for the points plotted on the graph, press the down arrow key.
A dashed vertical line appears on the graph. Refer to Figure 12.

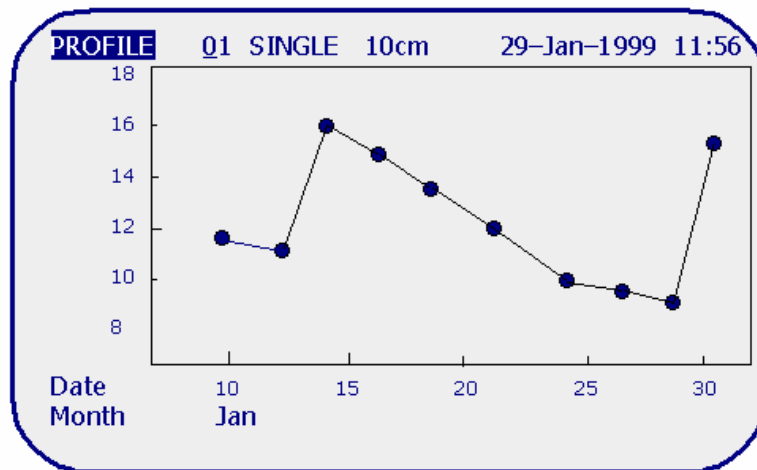

Figure 12—To show dashed vertical line

6. Use the arrow keys to move the dashed line across to a desired data point to view further information.
The exact value of the data point through which the dashed line passes displays below the x-axis. The soil moisture content is given first, followed by the date and time at which the reading was taken.
7. Use the *up* arrow key to return to the top of the screen.

Summed mode

The screen displayed in **SUMMED** graph mode is similar to that of **SINGLE** graph mode. The information however, represents a sum of depth data rather than a single recording point in the profile.

Note: **SUMMED** appears at the top of the screen.

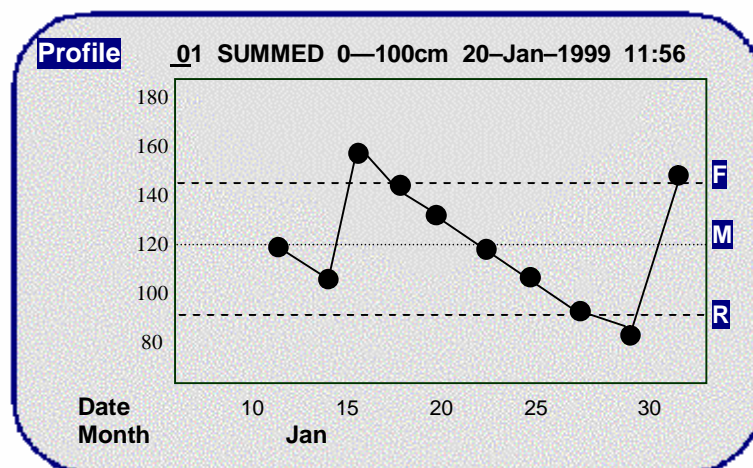

Figure 13—Summed graph screen

∅ To use the summed graph screen

1. Press the **SUMMED** mode key.
In this mode, additional features are:

feature...	means...
F	full point—refer to page 23
M	marker point—refer to page 23
R	refill point—refer to page 23

2. Use the arrow keys to move between **PROFILE** and **SUMMED**.
Note: When the screen first appears **PROFILE** will be highlighted.
3. To view another site profile:
 - type in the profile ID number using the numeric key pad when profile is highlighted or
 - press **NEXT** and **PREVIOUS** to systematically scroll through the site profiles.
4. Press the down arrow key to obtain exact soil moisture content values for the points plotted on the graph.
A dashed vertical line appears on the graph.
Note: The data values may not be displayed if they are well above or below the full or refill points. **Diviner 2000** establishes a scale in relation to these points. If the data is outside this scale you will not see the data values. To see the data values, you must remove or change (in table mode) the **Full** and **Refill** points.
5. Use the left and right arrow keys to move the dashed line across to a desired data point to view further information.
The exact value of the data point through which the dashed line passes displays below the x-axis. The soil moisture content is given first, followed by the date and time at which the reading was taken.
6. Use the *up* arrow key to return to the top of the screen.

Deleting data

∅ To delete a single data point from SINGLE or SUMMED mode

1. Move the vertical dashed line to highlight the point to be deleted.
2. Press **DELETE**.
You are prompted to confirm the deletion:
'Delete data for date/time, press enter for yes, any other key for no'
3. Press **ENTER** to delete the data point.

Part 1—The Diviner 2000 display unit and probe

Formatting the Diviner 2000

- Ø To delete all data points from SINGLE or SUMMED mode
 1. Move the vertical dashed line so that it highlights any data point.
 2. Press **DELETE** five times.
After the fifth time the following prompt will appear:
'Delete all data records? Press enter for yes, any other key for no'.
 3. Press **ENTER** to delete data.

- Ø To delete an entire profile from CALIBRATE mode
 1. Select the profile.
 2. Scroll down until **Datum** is highlighted.
 3. Press **DELETE three** times.
After the third time a message appears warning that further key presses will result in the selected profile being deleted.
 4. To delete continue to press **DELETE twice**.

Formatting the Diviner 2000

Warning:

Formatting the Diviner 2000 removes all setup information entered. This includes probe normalization, all profiles and their data. Please backup any data on the Diviner unit before formatting.

Enabling the unit configuration menu item

- Ø To enable the unit configuration
 1. Turn on the Diviner 2000.
 2. At the start up screen, press #2020.
 3. Press the 'setup' key to display the setup screen.
 4. A new menu option will be available called 'Unit Configuration'.

Ø Formatting the Diviner 2000

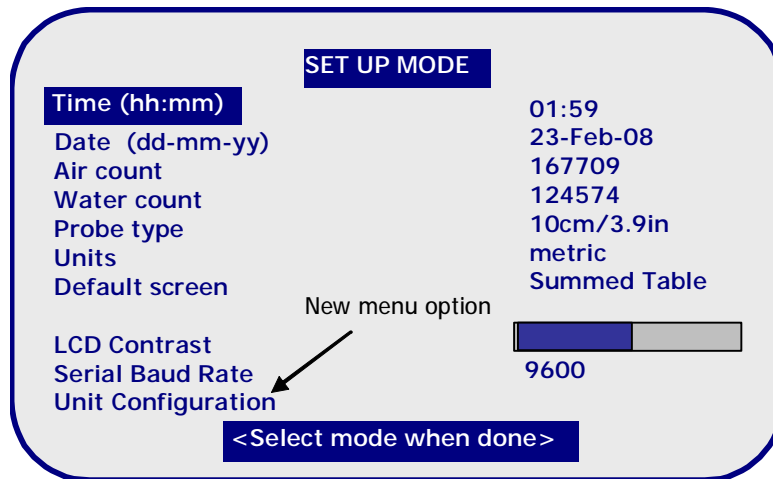

- 1.
2. Using the down arrow key, highlight the 'Unit Configuration' option and press 'Enter'. This will bring up the 'Unit Config Mode' screen.
3. Highlight 'Format' from the menu using the down arrow key and press 'Enter'.

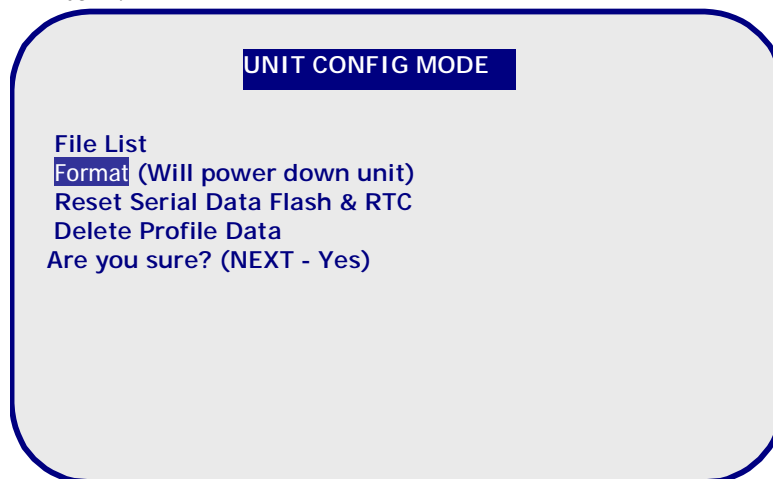

4. Press 'Next' to confirm the format. The unit will begin formatting. (Instead of 'Next' you can press "Setup" to cancel the formatting).
5. Once the formatting has completed, press 'Enter' to power down the Diviner.
6. Power on the unit for the configuration process to complete.

Irrigation scheduling using Diviner 2000 data

Why monitoring soil moisture for irrigation scheduling?

A crop uses the extent of its root system to extract water from different depth levels simultaneously. Measurements of the speed of water inputs or

Part 1—The Diviner 2000 display unit and probe

Irrigation scheduling using Diviner 2000 data

outputs from this soil at different depths have proved to be an excellent site-specific mirror of irrigation and crop water use.

Your Diviner 2000 data trends will help you to:

- calculate daily crop water use
- identify the active root zone
- recognize irrigation Full Point and the onset of crop water stress.
Note: this information is used collectively to build a soil water budget on which the irrigation schedule is based.

From your plotted data trends, you may also observe water logging and rising water tables.

To observe and understand the soil water trends you need to:

- take frequent soil moisture readings
- plot your data on the Sentek Pty Ltd Irrigation Management Chart or use IrriMAX Data Exchange to import Diviner 2000 readings.

Plotting data on your Irrigation Management Chart

The *Irrigation Management Chart* is used to record readings at specific sites. This information can also be kept on your PC, using IrriMAX.

A chart records three-month sets of **Diviner 2000** data from one site. In this way, seasonal data can be recorded from year to year and seasonal trends can be easily identified from one sheet.

The *Irrigation Management Chart* can be used to plot separate and summed level readings. Soil moisture values have not been included on the y-axis. The scale has been left blank as it will depend on the profile being monitored and the moisture content of the different textual layers. You are advised to customize the scale for your particular profile.

If you are plotting soil moisture contents for each depth interval, i.e. separate level graphs, start at the top left hand corner with the 10 cm layer. Start plotting data for the 20 cm layer below the 10 cm etc. For all separate layer trends use the same scale but different colors.

Ø To complete the header information

1. In the information section of the chart, fill in the number of the **Diviner 2000** profile that corresponds to the chart data.
Note: If there is more than one profile at the site being recorded on this chart, write the numbers for both profiles. Use different colors.
2. Fill in the name of the site.

3. Fill in the year the data was taken so that you can compare the same season next year.

Note: In this way you develop an irrigation management history.

4. Fill in the variety or rootstock that is currently being monitored at that site.

5. Fill in the age of the crop when measuring first started.

Note: Different crops require varying irrigation levels throughout different stages of their development. If you know the age of the crop when plotting began, you can identify water uptake changes at different crop development stages.

Ø To complete the chart for a separate level graph

Note: Use the y-axis scale on the right hand side of the *Irrigation Management Chart* to plot irrigation and rainfall events.

1. Customize the scale to suit your profiles.
2. Start in the left hand corner with the 10 cm layer.
3. Plot for the 20 cm below the 10 cm.
4. Repeat for all the layer trends using the same scale but different colors.

Other basic records required for irrigation management

With the soil water budget record you will need to keep:

- time and amount of irrigation
- time and amount of rainfall
- other weather data, e.g. temperature
- crop growth stage
- cultivating, spraying and harvesting activities.

Diviner 2000 Irrigation Management Chart

Profile No ____ Site Description _____ Irrigation Scheduling Unit _____
Year _____ Crop Age _____ Crop Rootstock _____ Soil Type _____

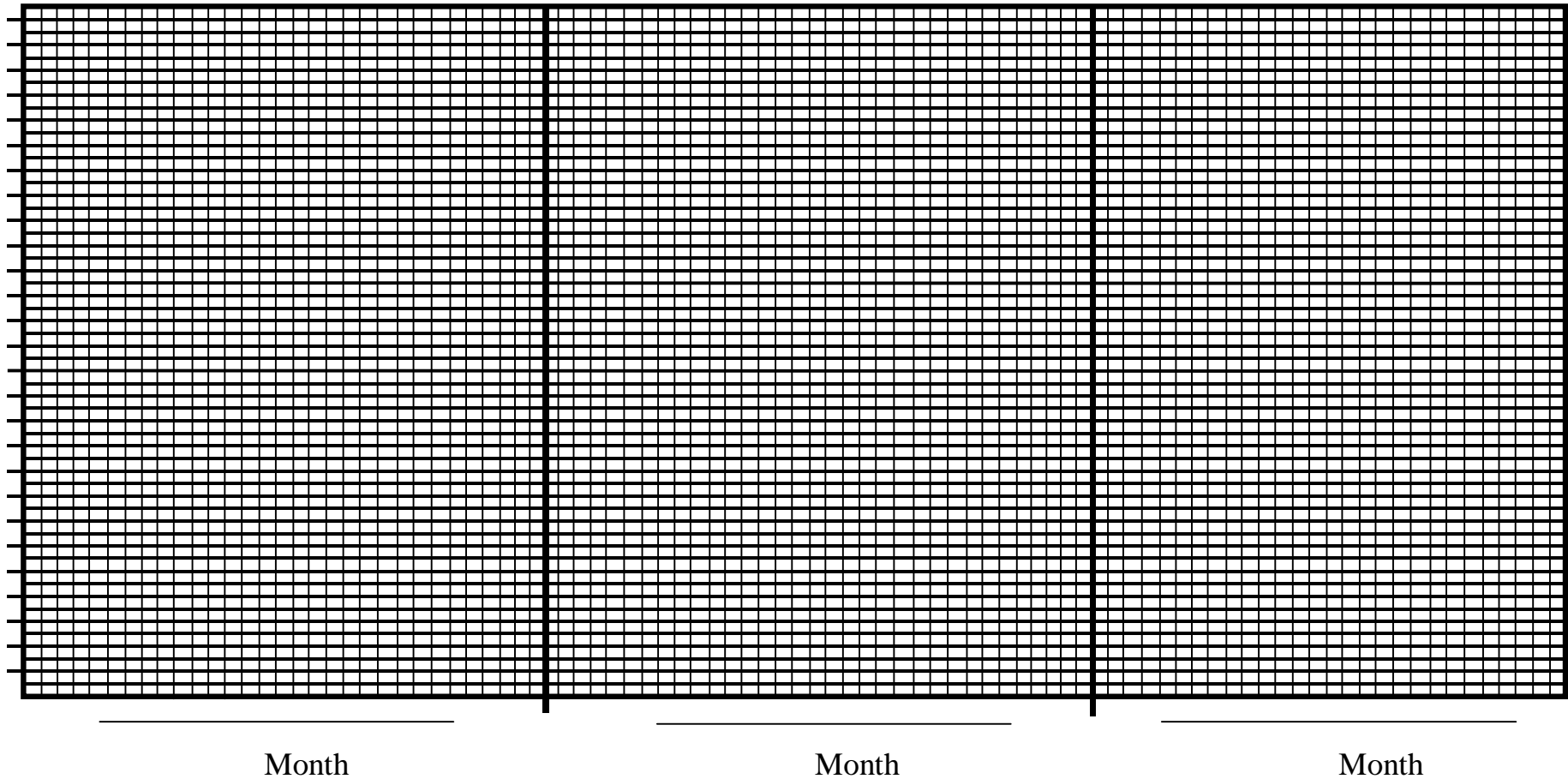

Figure 14—Irrigation management chart

How often should I take readings?

Review the Sentek Pty Ltd video, which came with your Diviner 2000 package.

The frequency of Diviner readings determines the resolution of the soil water trends. Two readings a week compared with two readings a day will result in quite different patterns on the graph.

Sentek recommends daily readings as a minimum with additional readings before and after an irrigation and rainfall event. This data collection schedule should produce a reasonable soil water trend resolution.

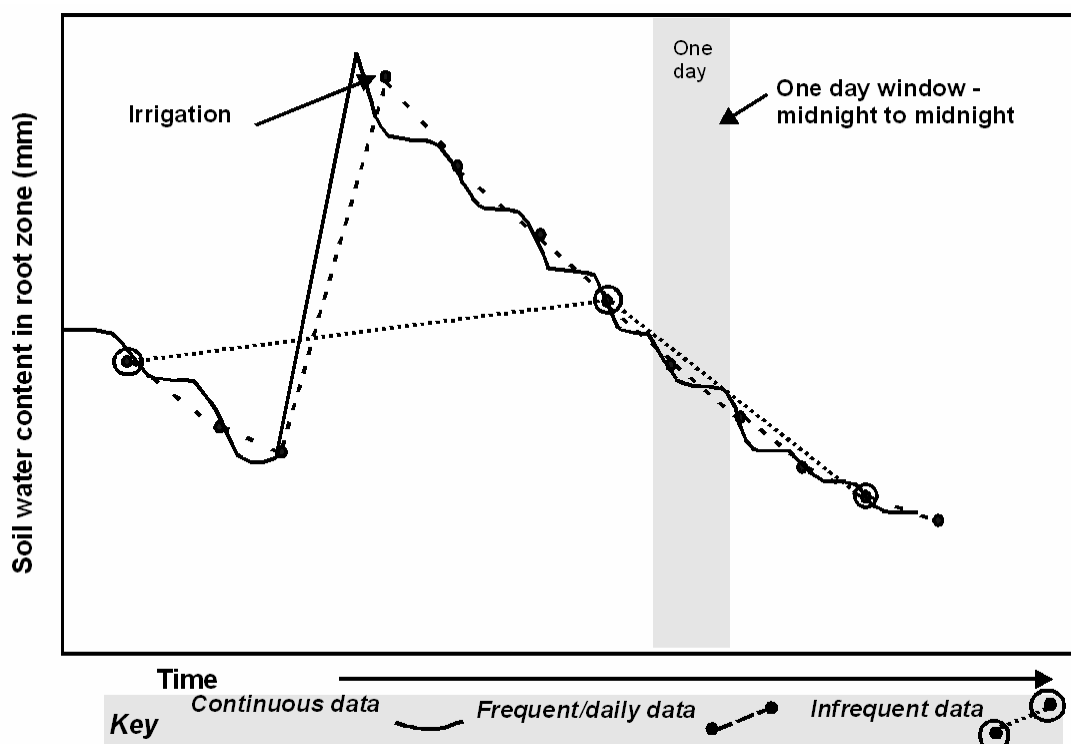

Figure 15—To show trends with continuous, frequent and infrequent data collection

The following section shows examples of data and trend interpretation as a result of continuous data collection. Readings taken twice daily (morning and evening) will produce a similar pattern.

Important soil water phases for irrigation scheduling

There are three important phases in crop soil water extraction. Understanding these phases is the basis for managing irrigation scheduling. These phases are described in Figure 16.

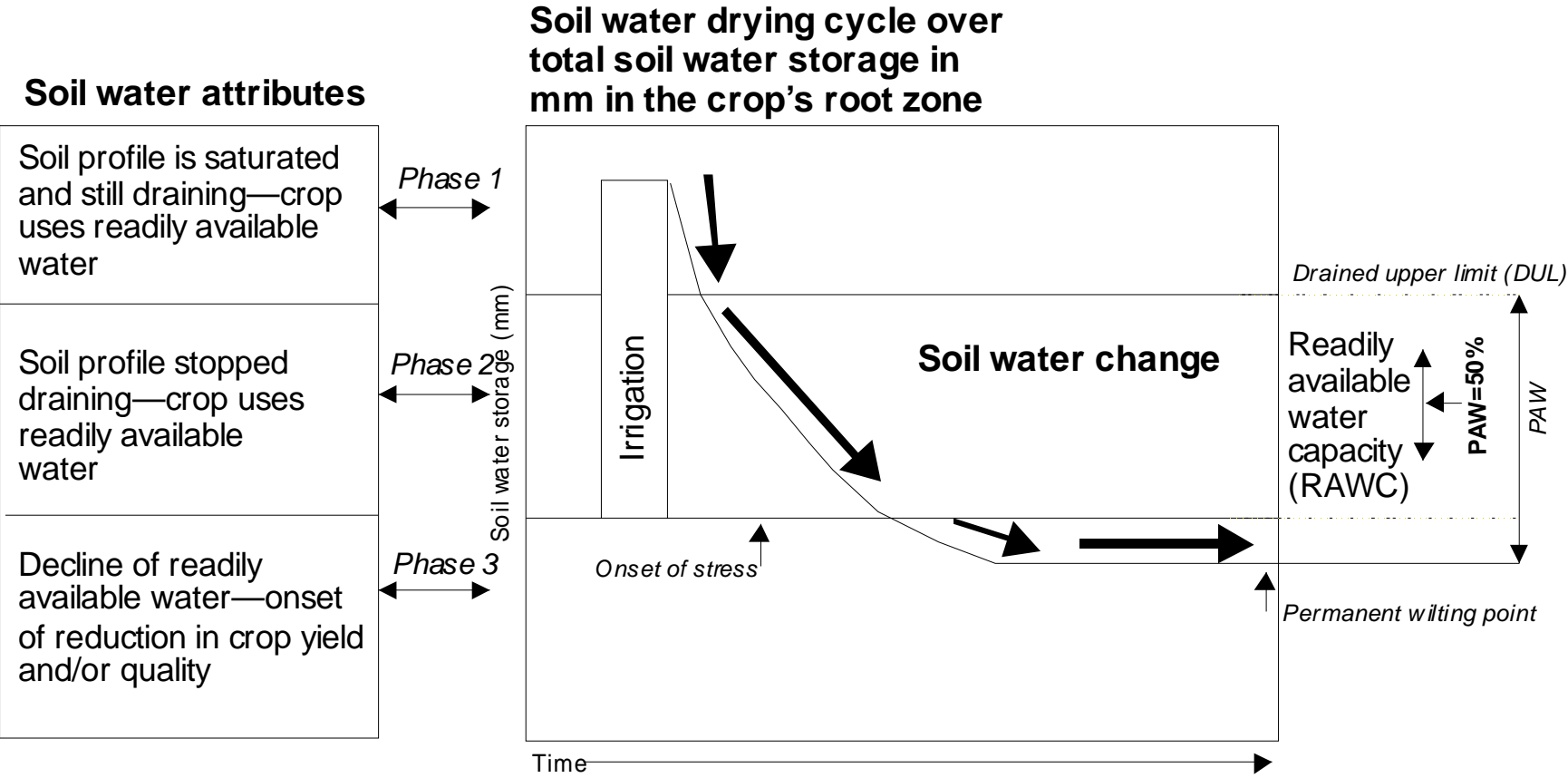

Figure 16—Soil water extraction phases

In *Phase 1* the change in volumetric soil moisture content is due to the processes of drainage and evapo-transpiration. In *Phase 2* and *Phase 3* the change is predominantly due to evapo-transpiration. The boundaries in volumetric soil moisture content between *Phase 1* and *Phase 2* and *Phase 2* and *Phase 3* are defined respectively, as the Drained Upper Limit (DUL) or *Field Capacity* and the Lower Limit (LL) or *Onset of Crop Water Stress*.

Phase 1 occurs when soils are wetted to saturation, which means all soil pores are filled with water. During *Phase 1* drainage through the profile proceeds at a rate determined by soil structural attributes, slowing appreciably after 1-2 days for most irrigated soils. However, much shorter phases have been observed in coarse sands and longer phases in clays.

The soil moisture content of a profile can be monitored during *Phase 1* and the start of *Phase 2* and plotted as a function of time (Figure 16). The time when the soil is in a fully watered but drained state, can be identified. The amount of water left in the root zone is called the *Field Capacity*. *Field Capacity* is the moisture content after drainage of the gravitational water and it is the upper limit of moisture held in the soil by capillarity. *Field Capacity* is most important in adjusting the refill amount for a particular soil type and depth of root zone in order to prevent over-irrigation.

The amount of water present during *Phase 2* is the difference between the *Field Capacity* and the *Onset of Crop Water Stress*. It is summed over the plant rooting depth and called the *Readily Available Water Capacity (RAWC)*, as distinct from *Plant Available Water (PAW)*. *PAW* describes the amount of water extracted by a crop between the *Field Capacity* and the *Permanent Wilting Point*. The *Permanent Wilting Point* is defined as the soil moisture content at which the crop is subjected to irreversible wilting. During *Phase 2*, water is freely and readily available to the crop, which does not experience any stress.

RAWC is preferred for use in irrigation scheduling because its defined lower limit (*Onset of Crop Water Stress*) is an exact irrigation trigger index of the crop that signals the onset of water stress from a crop's point of view. This is in contrast to the arbitrary index such as 50% threshold of *PAW*, which is an estimate and not a measurement of the crop's water need.

Phase 3 shows a declining water use by the plant. The decline is specific to each crop and corresponds to the onset of yield and/or quality reduction. The boundary between *Phase 2* and *Phase 3* is the *Onset of Crop Water Stress*. This is another key indicator for good irrigation management.

Part 1—The Diviner 2000 display unit and probe

Irrigation scheduling using Diviner 2000 data

The *Onset of Crop Water Stress* concept is the soil moisture content in the plant root zone when the first observable slow-down of the maximum daily crop water use rate after irrigation or rainfall occurs.

This slowdown should not be caused by a change in weather conditions, phenological stage of the crop, crop disease, harvest, spraying with chemicals or insect damage. These factors need to be excluded through crop observation and weather monitoring. In other words, a slowdown in soil water change after a cool weather change is only a temporary matter that does not necessarily mean the onset of crop water stress. The slowdown of daily soil water changes should correlate only with the starting difficulties of the plant to develop sufficient osmotic pressure to extract soil water from a diminishing soil water reservoir.

Crop water requirements vary with stage of growth. Long term monitoring of plant physiological parameters will improve the accuracy with which the refill point is determined for different crop growth stages.

Examples of data and trend interpretation

The following section describes data and trend interpretation through graphs, which demonstrate a pattern rather than specific data. The patterns described are:

- daily soil water changes
- active root zones
- onset of water stress
- identifying Full Point
- water logging
- rising water tables.

Daily soil water changes

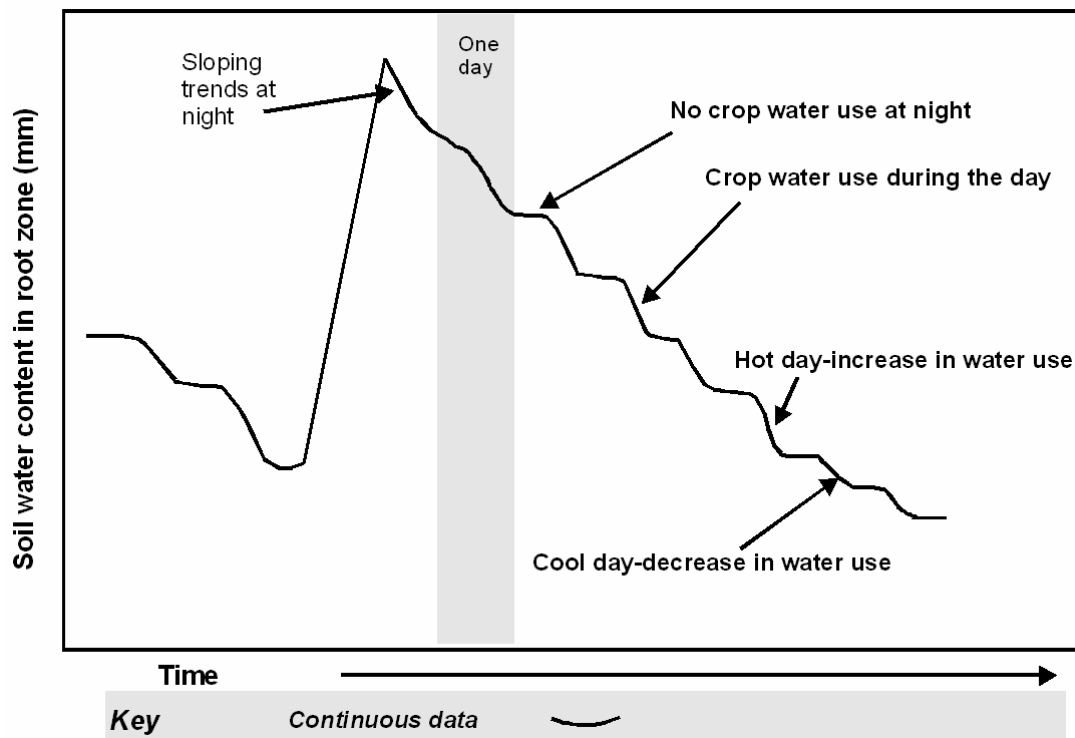

Figure 17—Daily Water changes

Figure 17 (Summed Graph) shows an irrigation event followed by a staircase dynamic.

The steep part of the stairs indicates soil water change during the day light hours (transpiration, and evaporation). Only in the first night after irrigation can you see a sloping trend at night indicating the soil profile is still draining. Then the nightly trend is flat indicating the soil profile has stopped draining and there is no drainage and crop water use at night.

The big step indicates an increase of crop water use on a hot day and the small step indicates a decrease in crop water use on a cool day.

The active root zone

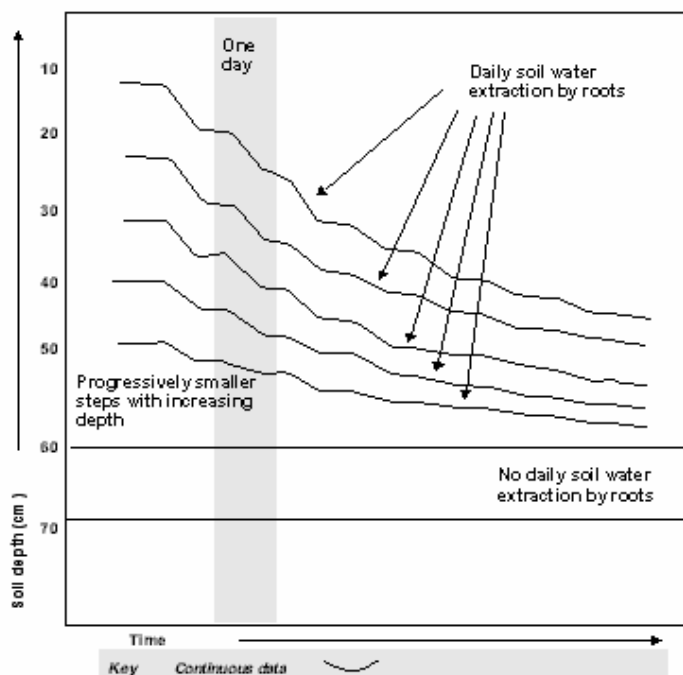

Figure 18—The active root zone

In Figure 18 daily changes at 10 cm, 20 cm, 30 cm and 40 cm are quite pronounced. At 50 cm the changes become more subtle and at 60 cm and 70 cm they are non-existent.

This soil water extraction pattern provides information about the part of the root zone actively involved in soil water uptake. According to these dynamics the bottom of the roots of this particular crop is currently active to 50 cm. Root activity is more pronounced at 10 cm, 20 cm and 30 cm than 40 cm and 50 cm soil depth.

Now you can match the irrigation depth to the depth of the crop root zone. In doing so you can also work out how much water needs to be applied.

Note: The Diviner display allows you to plot one soil depth level at a time. You need to step from depth level to depth level to visualize the different depth dynamics. The greater the number of readings, the higher the resolution in your graph.

Caution:

Do not rely entirely on separate level dynamics.

For example, mature trees showing a water uptake at 10 cm may indicate that the roots at a lower level have been destroyed by insufficient irrigation rather than a sustainable root system for a large tree at 10 cm.

The onset of crop water stress

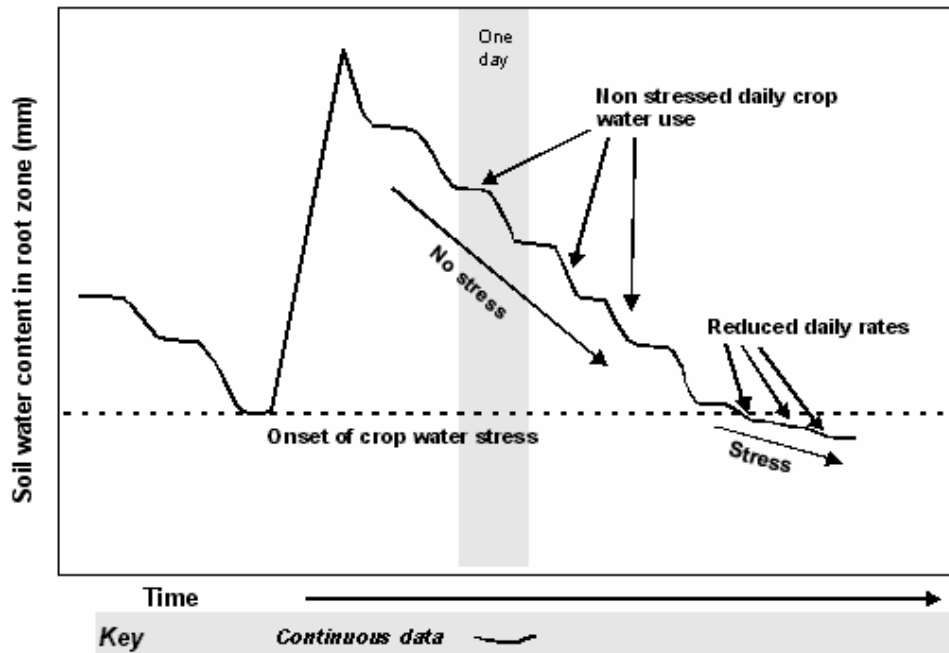

Figure 19—Onset of crop water stress

Figure 19 shows the soil daily soil water change dynamics after an irrigation event. Initially the steps are relatively even indicating a non-stressed soil moisture conditions for the crop.

Below the line marked *Onset of crop water stress* you can see a steady decline of daily use of water. Below this line, the daily use of water is more than 50 % less than that used the days above the line.

The *Onset of Crop water Stress* line is defined as:

The soil moisture content in the plant root zone when the first observable slow down of the maximum daily crop water use rate after irrigation or rainfall occurs.

The concept of Refill Point is a soil water budget level usually a notch above the Onset of Crop Water Stress threshold level.

This information shows when irrigation is needed to prevent crop water stress.

How to determine full point

To determine Full Point you need to find the depth of:

- the irrigation
- the active root zone.

Figures 20–23 show how to determine Full Point.

Part 1—The Diviner 2000 display unit and probe

Irrigation scheduling using Diviner 2000 data

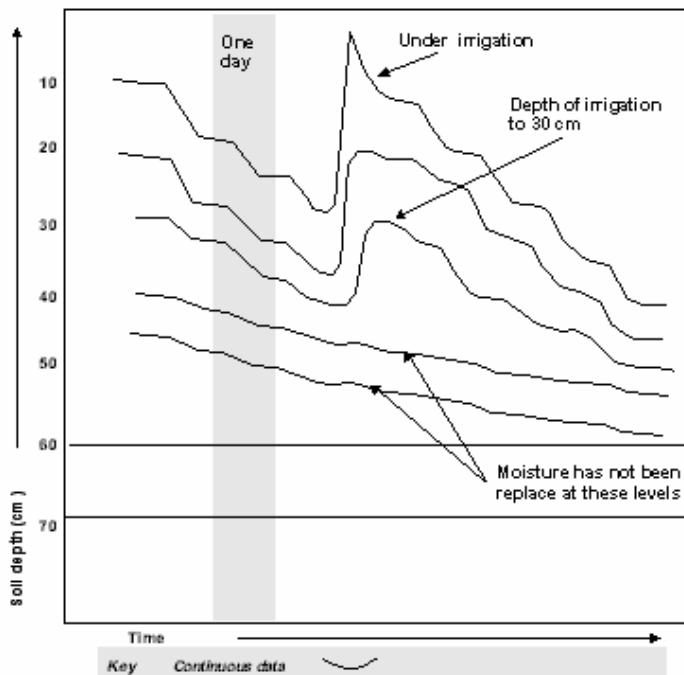

Figure 20—Root zone water extraction

Figure 20 shows root zone water extraction at the 10 cm, 20 cm, 30 cm, 40 cm, 50 cm depth level, but none at 60 cm and 70 cm. the reason for this pattern could be that the roots are:

- either, not present
- or, not involved in contributing water to the crop.

The depth of the irrigation has only wet the soil profile down to a depth of 30 cm and failed to replenish soil moisture at 40 cm and 50 cm. This means the soil moisture content at the bottom of the root zone has not been replaced. The depth of the irrigation is not matching the depth of the root zone. This irrigation can be classified as insufficient.

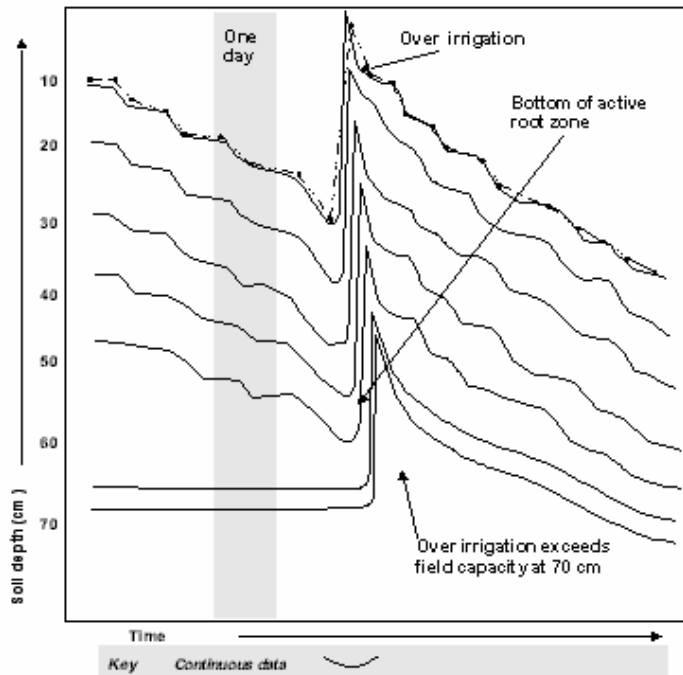

Figure 21—Irrigating beyond the root zone (over-irrigation)

Figure 21 shows the same site as Figure 20. In Figure 21 the depth of the irrigation creates a dramatic increase of soil moisture content down to 70 cm soil depth.

While Figure 20 shows the active root system extending to 50 cm, the pattern in Figure 21 shows wetting past the root zone, i.e. over-irrigation. Water, fertilizer and energy are wasted.

Part 1—The Diviner 2000 display unit and probe

Irrigation scheduling using Diviner 2000 data

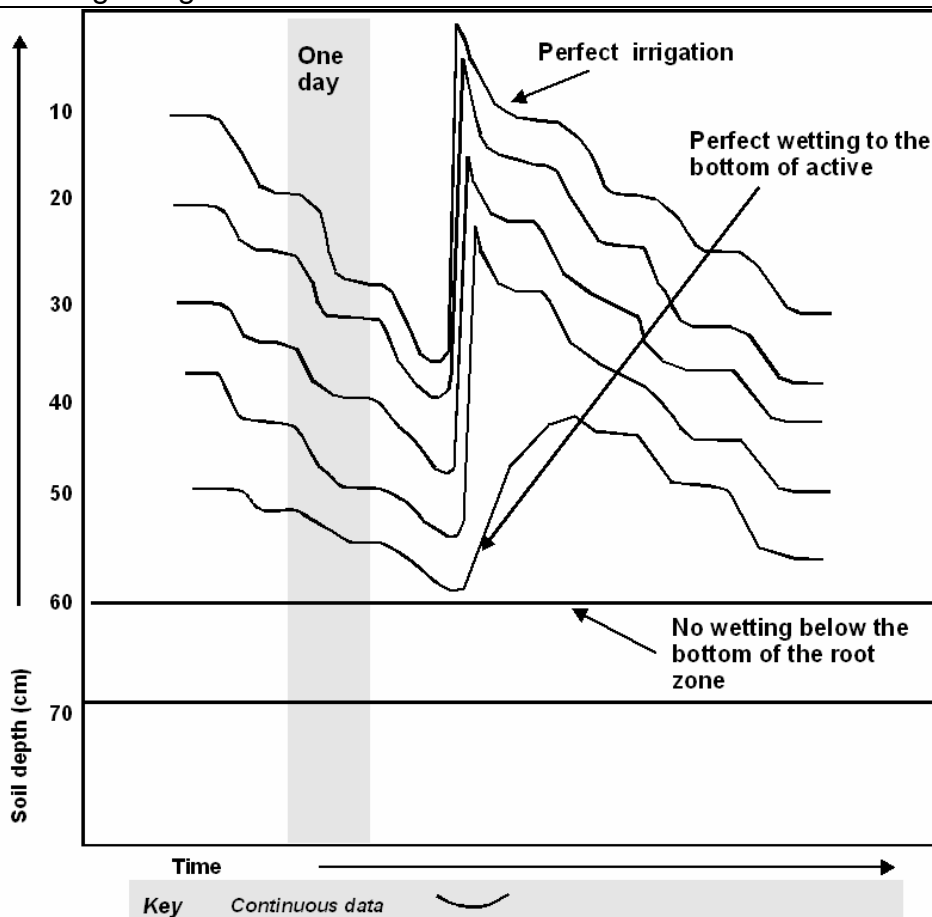

Figure 22—Depth of irrigation balances soil moisture extraction

Figure 22 shows the same site as Figures 20 and 21. Here the depth of irrigation replaces the amount of soil water extraction at the bottom of the root zone at the same magnitude as it was removed by the plant.

A slight *hump* in soil water increase and not the sharp peak of water drainage from this layer indicates the optimal depth of irrigation.

If you manage to reproduce, on your *Irrigation Management Chart*, the trends shown on Figure 22, then you have found the depth of irrigation that constitutes the Full Point.

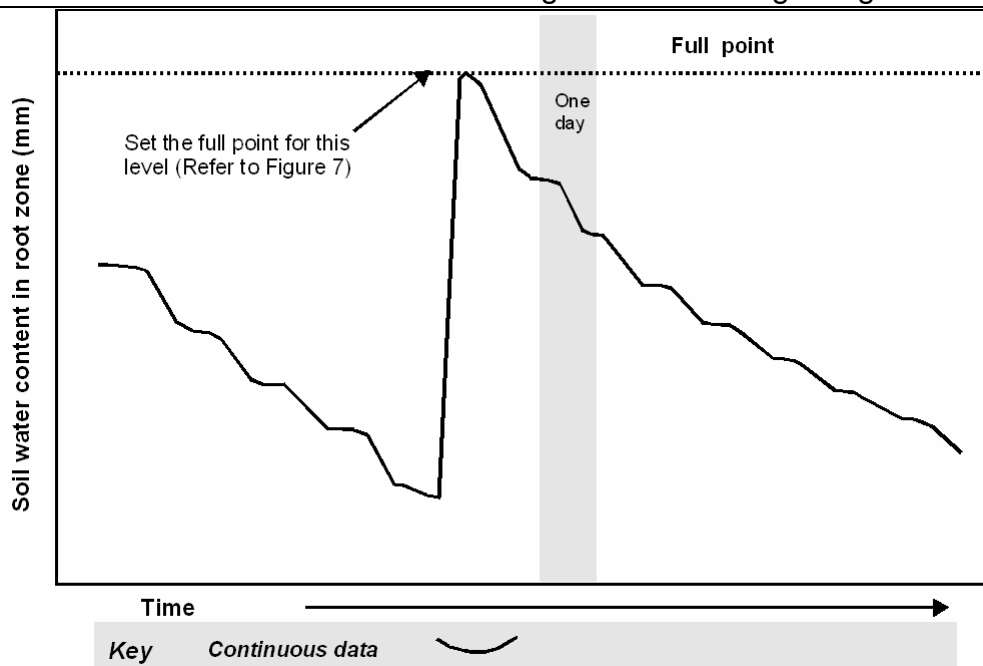

Figure 23—Full point in summed graph

Figure 23 shows in a summed form the same data as in Figure 22. The separate level data are showing an event that can be described as a good Full Point event. The line at the top of the summed irrigation peak indicates the Full Point.

The Full Point concept is a more refined concept than the once-used Field Capacity. Irrigation to Full Point rather than to Field Capacity replenishes the soil moisture content in the root zone. This avoids excessive drainage at the bottom of the root zone and nutrient starvation through leaching to the whole plant root zone.

Full Point is defined as:

The soil moisture content after an irrigation, which replaces the amount of soil water extraction at the bottom of the root zone, at the same magnitude as it was removed by the plant. The key point is that the soil moisture content replenishment in the soil profile of the plant root zone should not produce a significant drainage component below the bottom of the root zone, wasting water and fertilizer.

Water-logged conditions

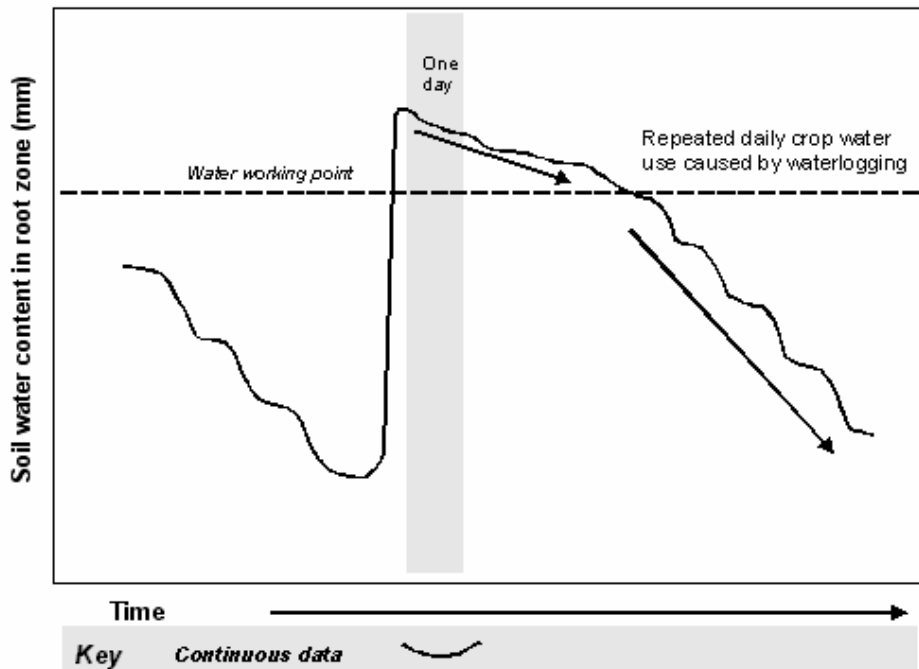

Figure 24—Water-logging

Figure 25 shows a slow down of crop water use for four days after an irrigation event.

This is an example of flood irrigated cotton grown on heavy clay soils showing the symptom of water-logging.

Water-logging indicates a soil moisture content, usually between the field capacity and saturation threshold, where the rate of crop water use is reduced by a limited supply of soil air to the root zone.

Finding the water table

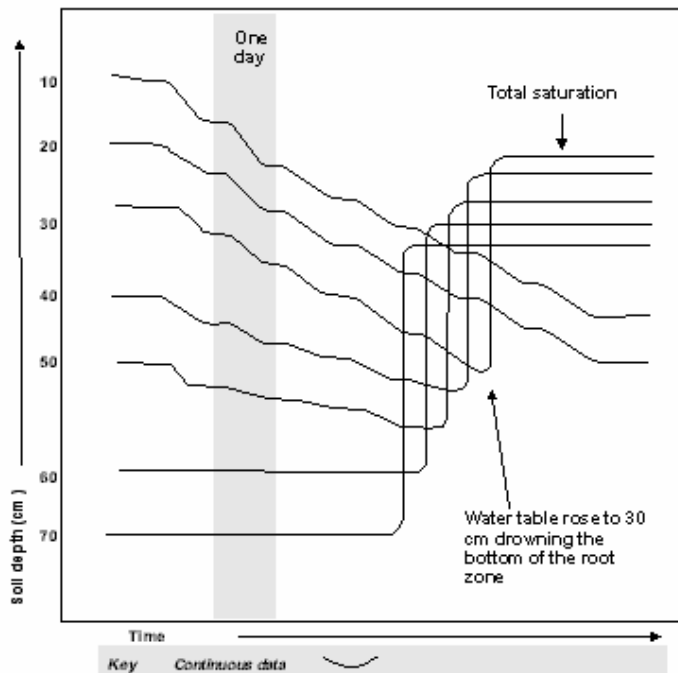

Figure 25—Rising water tables

Figure 26 shows the development of a water table, which rises into the crop root zone. The flat lines indicate depth and duration of total saturation of the soil profile.

Constructing site specific soil water budgets

The previous section describes how to determine Full and Refill Points. Now you can construct a soil water budget for optimum crop productivity.

Ø To construct a soil water budget

1. Enter the Full and Refill points in your diviner 2000 display unit, and/or your irrigation management chart.
2. Ensure that soil moisture content remains between these two points (refer to Figure 22).

Part 1—The Diviner 2000 display unit and probe
Irrigation scheduling using Diviner 2000 data

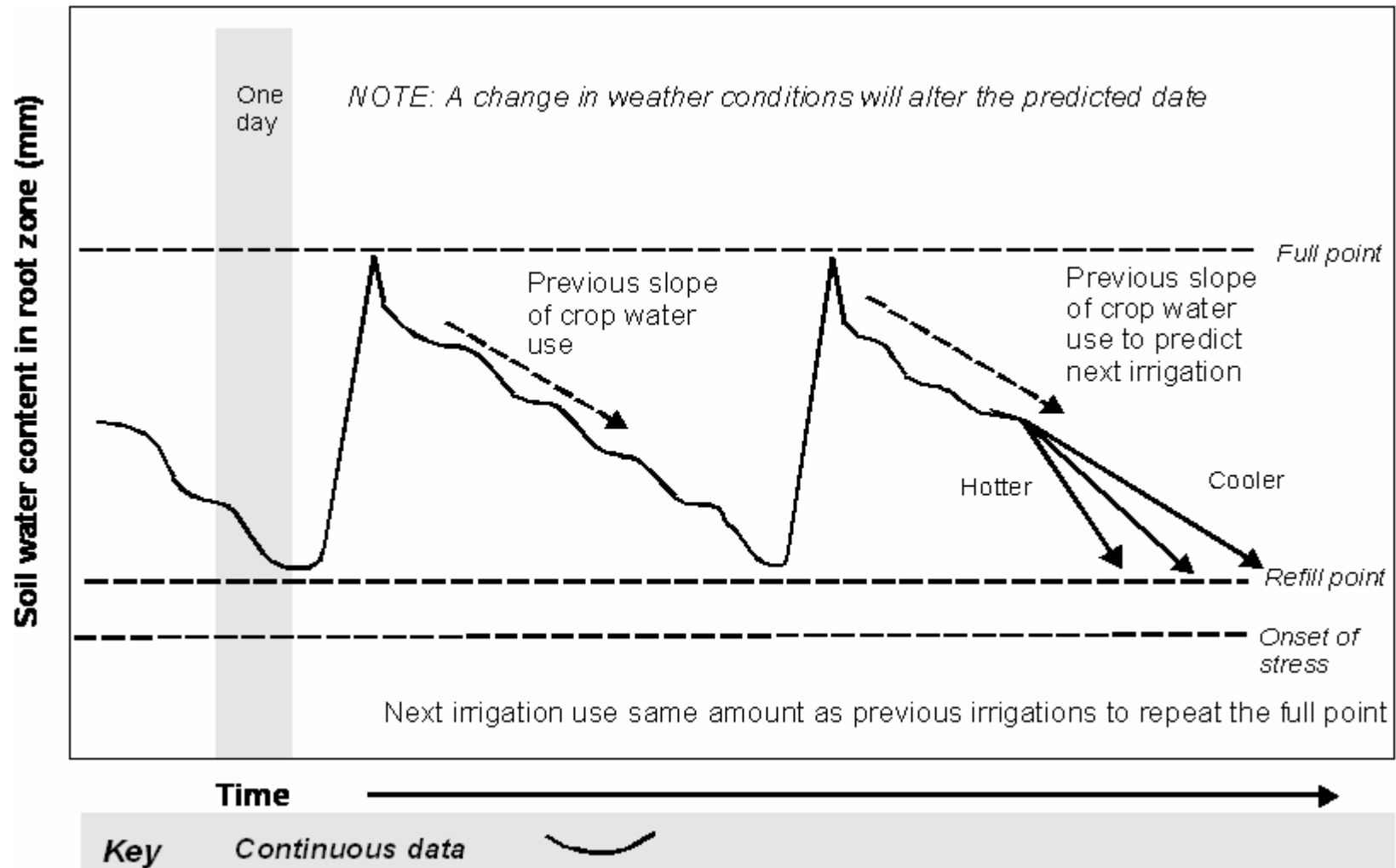

Figure 26—Soil Water Budget trends

Part 2 Diviner 2000 Utilities software

Before you begin

Information about versions

This guide was written for **Diviner 2000 Utilities** Version 1.7.8.

File Formats

Diviner 2000 Utilities supports two file formats. The Diviner data backup file format with the *.DBK file extension and the comma-separated values format with the *.CSV extension. The *.CSV format is a text based file format compatible with third party spreadsheet/database applications and is used to export data from the **Diviner 2000 Utilities**.

Using online help

Online help is available from any section of the software by doing one of the following:

- Press **F1** on the keyboard to display online help at the appropriate topic.
- Press **SHIFT+F1** on the keyboard to display **What's This** help for the selected screen element.
- Click **Help** to display help.
- Click  and point to a screen element to access **What's This** help.

∅ To print a help topic

From the **File** menu of the help window, click **Print Topic...**

∅ To print a group of related topics

In the *Contents* tab of the help window, click a book icon and click



All topics within the book topic level print.

Using Diviner 2000 Utilities

Diviner 2000 Utilities is a software application you can use to:

- download and store data from the **Diviner 2000** in a backup file
- restore data from your backup files to the **Diviner 2000**
- prevent a Diviner downloading into an incorrect database

Part 2 Diviner 2000 Utilities software

Using Diviner 2000 Utilities

- export the moisture readings stored in backup files to a standard CSV file for use in third party applications such as spreadsheets, e.g. Microsoft Excel.

For downloading the data from Diviner 2000 and restoring data to the unit a serial connection needs to be established. The export of the data to the CSV file however, does not require serial connection since it uses the backup file(s) as the source of data.

What information is backed up and restored?

The **Diviner 2000 Utilities** backs up all current data, all the setup profile information and soil calibrations from the **Diviner 2000** display unit. When a backup file is restored to the display unit, the existing data, settings and calibrations are overwritten with the backup details.

Note: Information that is not included in the backup is:

- probe air and water counts
- serial communication and display settings
- display unit date and time

Record air and water counts and store in a safe place with your backup disks.

Installing Diviner 2000 Utilities

Ø To install Diviner 2000 Utilities (Windows)

1. Start Windows
2. Insert the installation disk into the CD/DVD drive.
3. CD starts automatically. If it does not, select RUN from the Start Menu , type D:\setup.exe and click OK (where D: is your CD drive letter)
4. Read the *Welcome* and click **Next** to continue.
The *Software License Agreement* window displays.
5. To accept the license agreement and continue, click **Yes**.
The *Choose Destination Location* window displays.
6. To choose the correct setup path, do *one* of the following:
 - Click **Next** to accept the default.
 - Click **Browse** and select the preferred setup path and click **Next**.
The *Select Program Folder* window displays.
7. To ensure the correct program group is used:

- Click **Next** to accept the default.
8. The progress meter displays and the **Diviner** files are installed. The **Question** message box displays asking if you want to place a shortcut to the **Diviner 2000 Utilities** on your desktop.
 9. To place a shortcut on the desktop, click **Yes**. The *Setup Complete* window displays.
 10. Click **Finish** to reboot the PC.
Note: It is important to reboot the PC after the installation process is completed to ensure the installed software functions properly.

Starting Diviner 2000 Utilities

∅ To start Diviner 2000 Utilities

1. From the **Windows Taskbar**, click  and point to **Programs**.
2. Point to **Sentek**, point to **Diviner 2000 Utilities** and click **Diviner 2000 Utilities**.
The **Diviner 2000 Utilities** window displays.



If you chose to have Desktop icons installed on your **Windows** desktop during the installation, you can also start **Diviner 2000 Utilities** by double-clicking this icon.

The Diviner 2000 Utilities main window

The **Diviner 2000 Utilities** main window is used to manage **Diviner 2000** data on a PC. From the main window you can:

- backup data from the **Diviner 2000** display unit to your PC
- restore backed up data from your PC to the **Diviner 2000** display unit
- View and delete database ID tags stored on the **Diviner 2000** display unit
- export backed up data to other software applications (through CSV files).

Part 2 Diviner 2000 Utilities software

The Diviner 2000 Utilities main window

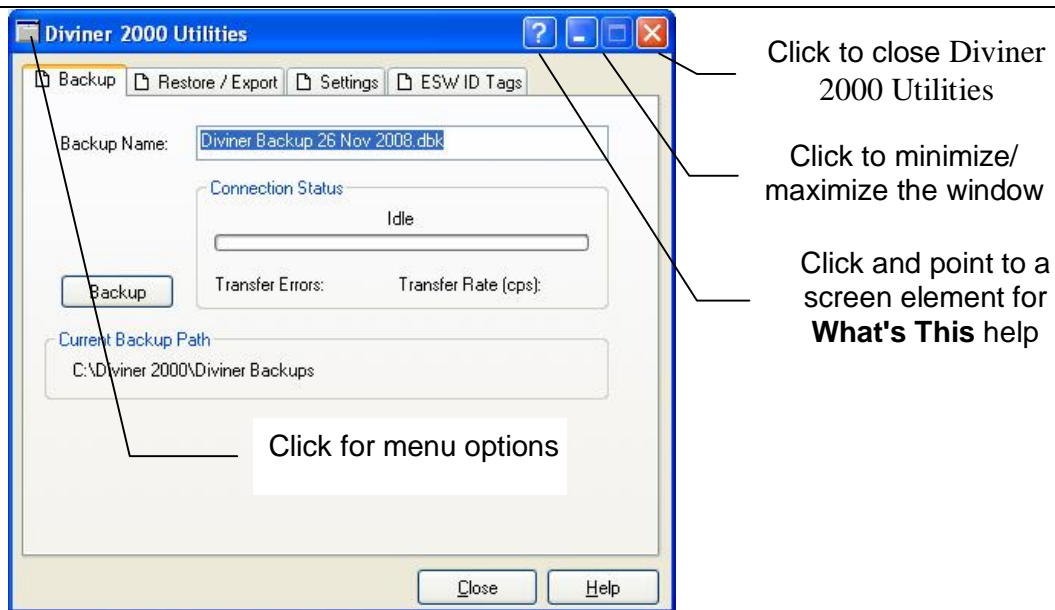

The main window of **Diviner 2000 Utilities** has four tabs:

- **Backup**—to backup data and settings information from the **Diviner 2000** display unit to PC.
- **Restore/Export**—to restore data back to the **Diviner 2000** display unit or to export backup files to the CSV file format.
- **Settings**—to set the communication options (between the **Diviner 2000** display unit and the PC) and backup path.
- **ESW ID Tags**—to match Sentek databases with Diviner 2000 display units

The following buttons are common to all tabs on the **Diviner 2000 Utilities** main window.

Click this button...



To...

close the **Diviner 2000 Utilities** main window.
Note: If you have made any unsaved changes to the **Settings** tab, you are prompted to save or reject the changes.

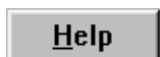

access the Diviner 2000 Utilities online help file.

Establishing communications

The **Diviner 2000** display unit is connected to your PC via a standard serial port. A successful connection requires you to configure the **Diviner 2000** display unit and the **Diviner 2000 Utilities** software with matching communication settings.

Communication settings for the **Diviner 2000 Utilities** are configured in the **Settings** tab of the main window. These settings are a once-only setup. The current backup path for backup files is also defined in the **Settings** tab. You can change this path to suit your own file management.

For example, you could use directory names based on crops, site geography or dates for each backup.

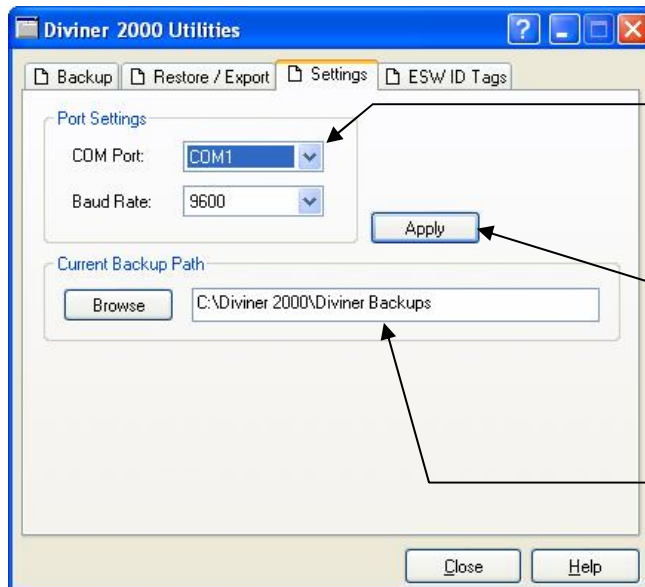

Ensure that the COM Port matches the port used for the connection and the Baud Rate matches the display unit setting.

Click to apply changes to the Port Settings.

Enter the path where you want to keep backup files.

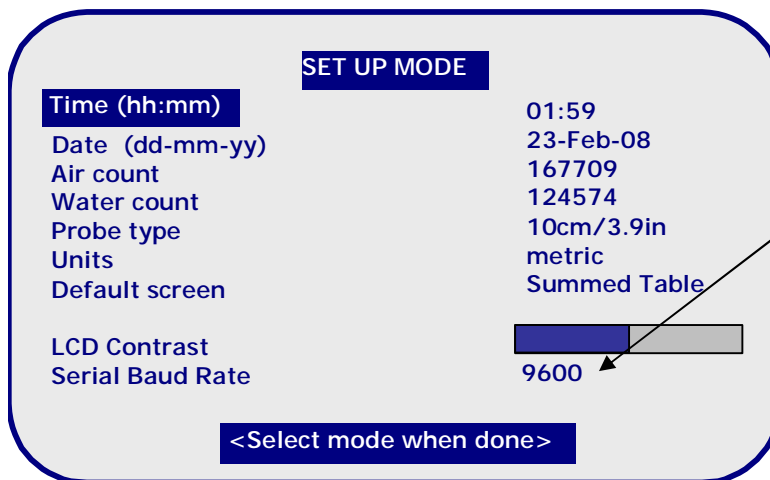

Diviner Utilities Baud rate must be the same as this value in the Diviner 2000 Display Unit.

Ø To configure the Diviner 2000 Utilities

1. Select the *COM Port* to which the **Diviner 2000** display unit is connected.
Up to four communications ports (COM1 to COM4) are supported for connection.
2. Select the *Baud Rate* for connection to the **Diviner 2000** display unit.
Note: The same rate must also be set in the display unit.
3. Type or browse for the *Current Backup Path* for backup files.

Part 2 Diviner 2000 Utilities software

The Diviner 2000 Utilities main window

4. Click **Apply** to apply the changes to the software.
A message box displays, advising you to restart the software for the changes to take effect.
5. Click **OK** to close the message box.
6. Close the **Diviner 2000 Utilities** and restart it.

Ø To prepare for communications

1. Connect a serial RS-232 cable between the diviner and the PC.
Note: Record which communication port the cable is connected to on the PC, e.g. COM1.
2. Turn on the **Diviner 2000** and press **SETUP**.
The *Setup Mode* menu displays.
3. Use the up/down arrow keys to highlight **Serial Baud Rate** in the menu.
4. Use the left/right arrow keys to select the appropriate baud rate.
The baud rate setting in **Diviner 2000 Utilities Settings** must match the baud rate of the **Diviner 2000** serial port. Start with the highest rate (34800).
5. Start the **Diviner 2000 Utilities** software and select the **Settings** tab.
6. Change the Diviner 2000 Utilities baud rate to match the rate selected in Step 4.

Note: reduce the baud rate in the Diviner 2000 and in Diviner Utilities if the communication does not appear to be reliable.

Backing up Diviner 2000 data

The *Backup* tab of the **Diviner 2000 Utilities** main window is used to backup data from the **Diviner 2000** display unit to a backup file. The **Diviner 2000** display unit must be connected to a serial port of the PC before backup can begin. See *Establishing communications* on page 50.

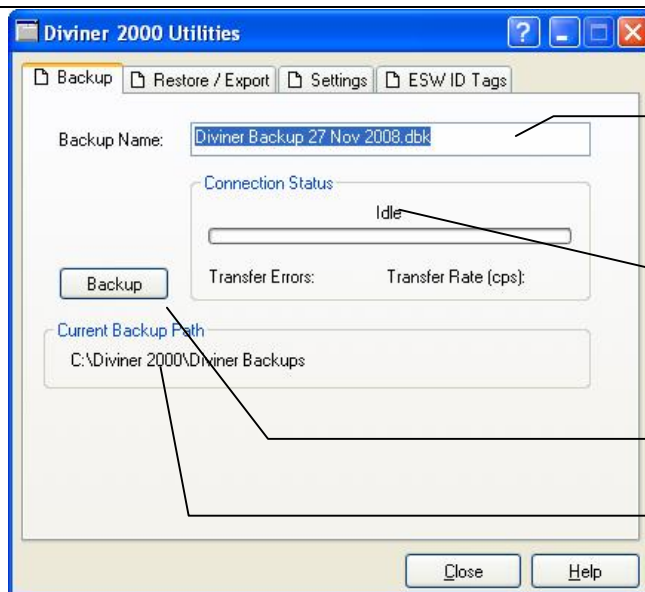

Diviner 2000 Utilities automatically creates a name for the backup file based on the backup date.

Check the connection status messages as communication is established.

Click to establish a connection and create the backup file.

The current backup path can be changed, if required, in the *Settings* tab.

Ø To backup data from the Diviner

1. Prepare the **Diviner 2000** display unit and **Diviner 2000 Utilities** software for communications as described in *Establishing communications* on page 50.
2. From the *Backup* tab of the **Diviner 2000 Utilities**, do one of the following:
 - Leave the default backup file name unchanged.
 - Type in a new file name.

Note: The *.DBK extension is automatically added to the file name.
3. Click **Backup** to begin the backup process and display connection status.

Note: The **Backup** button changes to **Cancel**. Click **Cancel** to cancel the backup process.

A status message displays the time of the completed operation.

Restoring and Exporting data

The **Restore/Export** tab is used to:

- restore data (from the backup files) to the **Diviner 2000** display unit

export data (from the backup files) to a text based CSV file.

Restoring data to the Diviner 2000

The **Diviner 2000** display unit must be connected to a serial port of the PC before data restoration can begin. See *Establishing communications* on page 50.

Caution:

Restoring data to the **Diviner 2000** display unit overwrites all existing data, settings and calibrations (except probe air and water counts).

Ensure that you have backed up existing data before restoring previous data.

Exporting data to a CSV file

Data can be exported from a backup file to a comma-separated variables format with the *.CSV extension. This text-based file format can be viewed and analyzed with third party software such as *Microsoft Excel*.

Since **Diviner 2000** can hold more than one profile, exported data is separated into profiles. You can export single or multiple profiles; each profile is exported as a separate CSV file. Each CSV file name is generated automatically based on a nominated base file name. For example, a base file name of *Diviner Backup 02 Mar 1999.csv* with profile numbers 2 and 4 selected will generate two files called:

- *Diviner Backup 02 Mar 1999 (Pro02).csv*
- *Diviner Backup 02 Mar 1999 (Pro04).csv*.

The data format to be exported may be either raw or calibrated.

Note: If you export multiple profiles, each profile will use a common data format.

When exporting data, **Diviner 2000 Utilities** checks if a file already exists with the same name. If the file name exists, **Diviner 2000 Utilities** checks for compatible data formats, calibration data and sensor depths. If the data is compatible, only new (later in date) data is added to the appropriate CSV file. If the data is not compatible, no data is exported—export is denied.

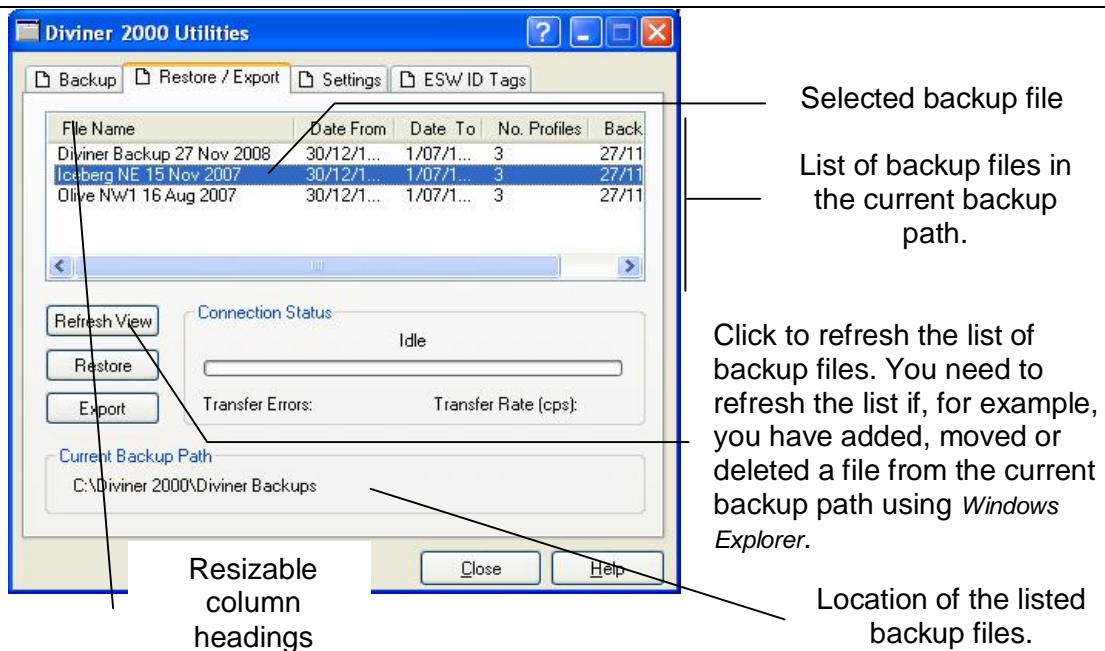

To increase or decrease the width of a column, click and drag the line separating the columns in the column heading. You can also double-click the line to resize the column to the minimum useable width.

∅ To restore data to the Diviner

1. Prepare the **Diviner 2000** display unit and **Diviner 2000 Utilities** software for communications as described in *Establishing communications* on page 50.
2. From the **Restore/Export** tab of the **Diviner 2000 Utilities**, select the file that contains the data to be restored.
Note: If you cannot see your backup files, check that the current backup path corresponds to the file location of your backup files.
3. Click **Restore** to begin the restore process and display connection status.
Note: The **Restore** button changes to **Cancel**. Click **Cancel** to cancel the backup process.
A status message displays the time of the completed operation.

∅ To export data to a CSV file format

1. From the **Restore/Export** tab of the **Diviner 2000 Utilities**, select the file that contains the data to be exported.
Note: If you can not see your backup files, check that the current backup path corresponds to the file location of your backup files.

Part 2 Diviner 2000 Utilities software

The Diviner 2000 Utilities main window

2. Click **Export**.

The **Export to csv** dialog box displays.

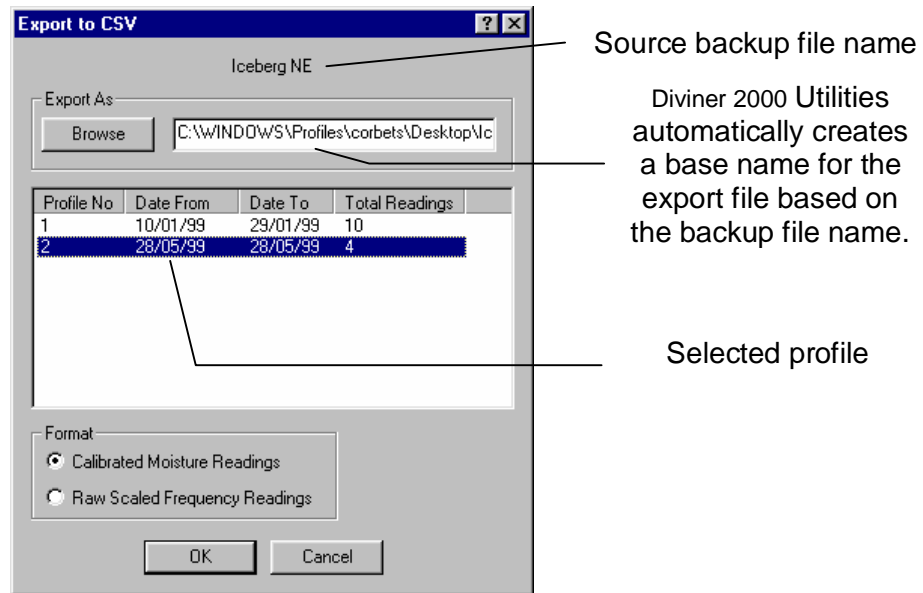

3. Do one of the following:

- Accept the default base file name and path (the default name is based on the backup name).
- Type or browse for the required directory path and type a new name if required.

4. Select the required profile(s) to export.

You can select multiple profiles for exporting by holding the **CTRL** or **SHIFT** key down and selecting each profile. The appropriate profile number is automatically added to the export file name.

5. Select the data format to export.

The default format is *Calibrated Moisture Readings*.

6. Click **OK**.

A message box displays advising you of the outcome of the export process. See page .56

Exporting data messages

A message displays after attempting to export data to a CSV file. The following sample messages are displayed under the conditions described.

Messages

Meaning/Action

The following profiles were successfully exported to newly created files:

1. Profile 02
2. Profile 03

No action is required. The export process was successful.

Messages**Meaning/Action**

The following profiles had no relevant changes in them from existing profile files:

1. Profile 02

The export process did not proceed. A CSV file of the same name (same base name and profile number) was found in the destination location. The file is compatible with the selected profile being exported but no changes were detected. It is probable that you have exported the same profile twice.

The following profiles were unable to be exported!
Probable causes may be because the destination files already existed and contained modified or mismatched information that would not allow the current profile to be appended:

1. Profile 02'

The export process did not proceed because a CSV file of the same name (same base name and profile number) was found in the destination location which was incompatible with the profile being exported. This could be due to:

- incompatible data formats (data may belong to different profile)
- incompatible sensor depths (data may belong to different profile)
- existing file has been modified manually.

Using ESW ID Tags

The Diviner 2000 Display Unit must be connected to the serial port of the PC before the Refresh View or Delete Selected functions will work. (See *Establishing communications* on page 50.)

The ESW ID Tags tab is used to:

- View which logger ID's (located in the Sentek Databases) match the ESW ID Tags (.ID files) stored on the Diviner 2000 display unit. This will help prevent downloading to incorrect databases.
- Delete logger ID tags (.ID files) from the Diviner 2000 Display Unit once a Sentek Database is no longer being used.

For example, a Sentek Database created from a Diviner 2000 download would have a logger ID similar to this: "Diviner U95CJ49D75E00". This would mean that the Diviner 2000 Display Unit would need to have the file "U95CJ49D75E00.ID" in it to be able to download to that database.

Part 2 Diviner 2000 Utilities software

The Diviner 2000 Utilities main window

Ø Finding the ESW ID Tag

1. Open the **Irrimax** software. (Go to **Start - All Programs - Sentek - Irrimax**)
2. From a Workspace page in the Irrimax software, select **File**, then **Open**, then **Database**, and browse for a database (.sdb file) that you wish match with the Diviner Display Unit.
3. Once you have identified the database, select it and click **Open**.
4. Record the Logger ID (which appears in the top row of the “Logger Tree” column).

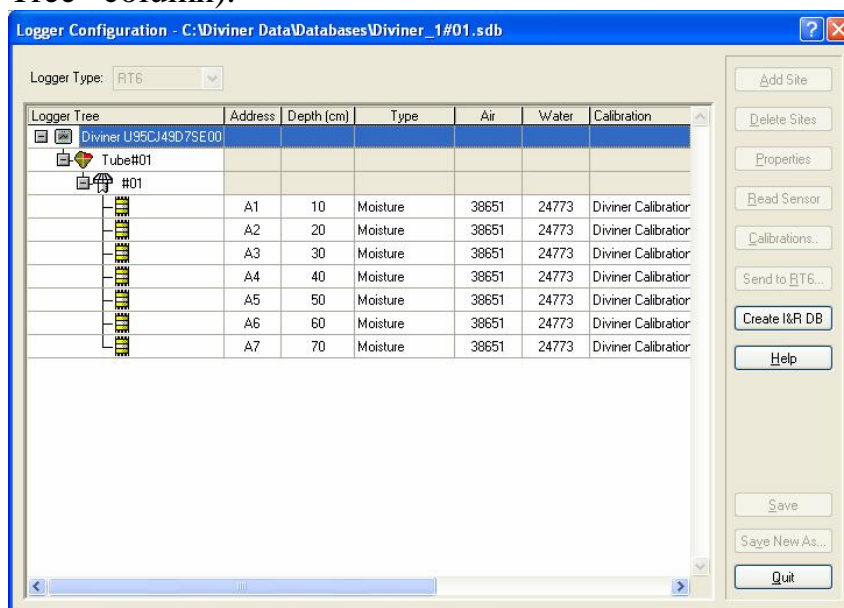

5. Prepare the Diviner 2000 Display Unit and the Diviner 2000 Utilities software for communications as described in *Establishing communications* on page 50.
6. From the **ESW ID Tags** page of the Diver 2000 Utilities software, click on refresh.

7. One of the ID Tags (.ID files) that appears should match the Logger ID that was identified in step 4.

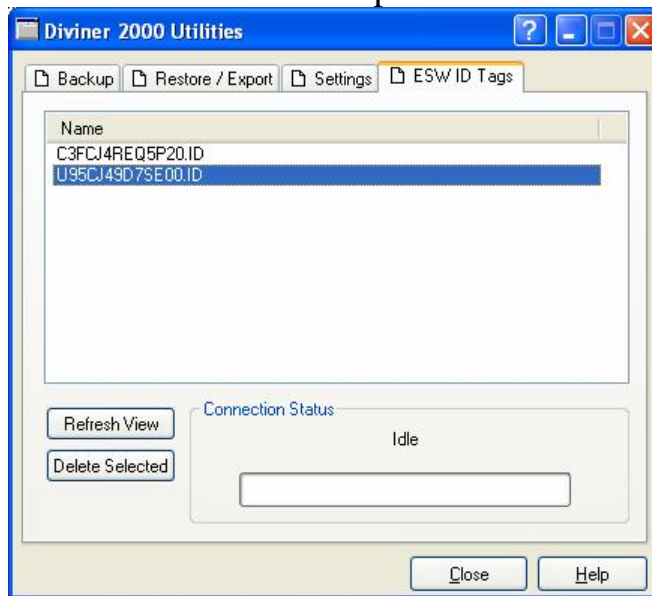

Ø Deleting ID Tags from a Diviner

1. Identify the ID Tag (.ID file) to be deleted from the Diviner 2000 Display Unit as described in *Finding the ESW ID Tag* on page 58.
2. From the ESW ID Tags tab of Diviner 2000 Utilities, highlight the ID Tag you wish to delete from the Diviner 2000 Display Unit.
3. Click once on **Delete Selected**
4. The following warning message will appear.

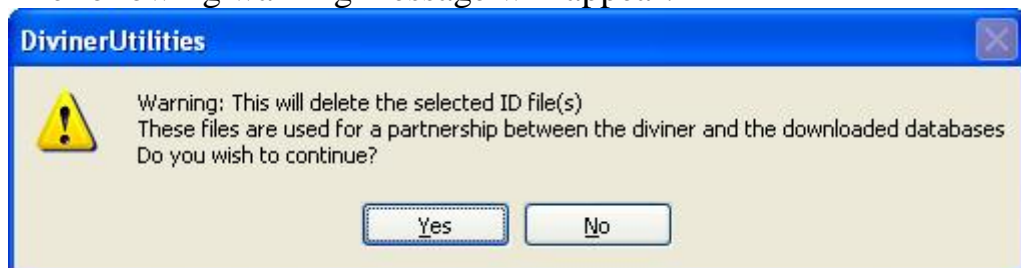

Click Yes to delete the selected ID Tag.

Note: ID files can be added to the Diviner later by following the on-screen instructions when a Diviner download is attempted to a database without a matching ID Tag.

Troubleshooting

Ø To unlock Diviner 2000

1. Press a 'mode' key to move out of and back into current screen.
2. Hold down the **ON/OFF** key for approximately five seconds so that the Diviner 2000 display unit resets.

Ø To ensure compatible communication settings

If you receive the following error message:



1. Check that the **Diviner 2000** display unit is turned on.
2. Check that the serial cable plugs are properly seated in both sockets.
3. Check that the serial cable is not damaged.
4. If you have more than one available serial port, check the *Settings* tab of the software and ensure that the port name specified corresponds to the physical connection.
5. Make sure that the baud rate for the **Diviner 2000** display unit match the baud rate for the **Diviner 2000 Utilities**.
6. Lower the baud rate (keeping the baud rates matched) and try again.
7. Turn off the **Diviner 2000** display unit.
8. **Reboot your PC, restart the Diviner 2000 Utilities** and try again.

Ø To format the Diviner 2000

This option can be a last resort when operation of the Diviner 2000 is inconsistent. Sentek recommends getting expert advice before proceeding

with formatting. The Diviner 2000 data should be backed up before formatting.

The steps required are describe in section *Formatting the Diviner 2000* page 28.

Ø To rectify charging problems

Symptom	Remedy
Diviner 2000 display unit fails to switch on or flashes on momentarily showing a low battery message	Plug a power pack into the charging socket and leave on charge for at least 4 hours. If the Diviner 2000 unit still fails to switch on, unplug and refit the charger for a second (and third, if required) 4 hour charging cycle. If the unit still fails to charge, see your local Distributor.
Diviner 2000 display unit fails to report a full battery status after a 4 hour charging cycle.	Remove the charger plug from the unit, refit the plug and leave for an additional 4 hour charging cycle. If the unit does not report a full battery status after three 4 hour charging cycles, it is recommended the unit and the charger be returned to your local Distributor for service.

Ø To undo fatal key errors

A fatal key error may occur if the Diviner unit is not powered off correctly.

1. Turn on the Diviner 2000.
2. At the start up screen, press #9990.
3. This will perform a reset/reboot of the display unit. No data will be lost

Ø Diagnosing scan failures

A failed scan can be caused by a number of things.

When a scan fails, verify that the soil profile is correct and ensure that the full depth of the profile is reached during the scan. Read *To scan (swipe and go)* on page 19.

A successful scan will never occur if the probe length is shorter than the length of the profile. You must either create a new profile or use a probe of the correct length.

Recommended reading

Greacen, E L (1981); *Soil Water Assessment by the Neutron*; CSIRO, East Melbourne, Victoria, Australia

Appendix A—Theory of Operation

Raw counts

Raw counts are the raw frequency readings by the sensor inside an access tube exposed to the air-water-soil medium to be measured. Raw counts range between 120 000 counts (taken in 100% water) and 160 000 counts (taken in 100% air).

The sensor operates at a very high frequency (in excess of 100 Mhz). It is not possible to tune all Diviner 2000 sensors to exactly the same raw count response when measuring a particular standard, e.g. in a water bucket. Therefore we have chosen not to work with raw data directly, but with frequency ratios or normalized counts. This allows you to use different Diviner sensors during the monitoring season and ensures meaningful data continuity.

Normalized counts or SF (Scaled Frequency)

Normalized counts represent the ratio of individual probe frequency reading responses (inside the access tube) in soil (F_S) compared with probe responses in air (F_A) and in water (F_W). SF readings usually range between the values 0 and 1. The frequencies in air, water and soil are passed through a normalization equation to determine a normalized count or scaled frequency (SF), defined as:

$$SF = (F_A - F_S) (F_A - F_W)^{-1}$$

Where:

- F_A is the frequency reading in the access tube while suspended in air
- F_S is the frequency reading in the access tube in soil
- F_W is the frequency reading in the access tube in the water bath.

Measurement technique

Volumetric soil moisture content is measured by responses to changes in the dielectric constant of the soil. The capacitance of a soil increases considerably with an increase in the number of soil water molecules, which are free to relax as their electric dipoles respond to the capacitor sensors field reversal. This measurement is proportional to capacitance and is also called specific polarization or electric dipole moment per unit volume. With the advent of microelectronics it is possible to measure the responses

of capacitance sensors within a soil profile and correlate it very highly to the dynamics of volumetric soil moisture content.

The capacitance technique in general has potential advantages over traditional nuclear soil moisture monitoring techniques such as the lack of random counting error, lighter equipment weights, quick responsive readings and no radioactive hazards.

Appendix B—Soil Moisture Management

What soil volume does the Diviner probe measure at a single depth level?

At a single depth level, the probe records moisture from a soil volume outside the access tube, which has a sphere of influence of:

- 10 cm vertical height
- 5–10cm radial distance from the outer wall of the access tube.

See xx

What are the water units?

For example, if the probe (provided it has been calibrated) reads one millimeter that means there is one millimeter of water content in a 100 mm thick soil slice on a volume basis. For that layer (and only that layer), this amounts to a volumetric soil moisture content of 1%.

What does 1% or 1 mm volumetric soil moisture content/10 cm or 100 mm soil depth mean?

You require one liter of water to cover one square meter (m²) to a soil depth of one millimeter.

Metric units:

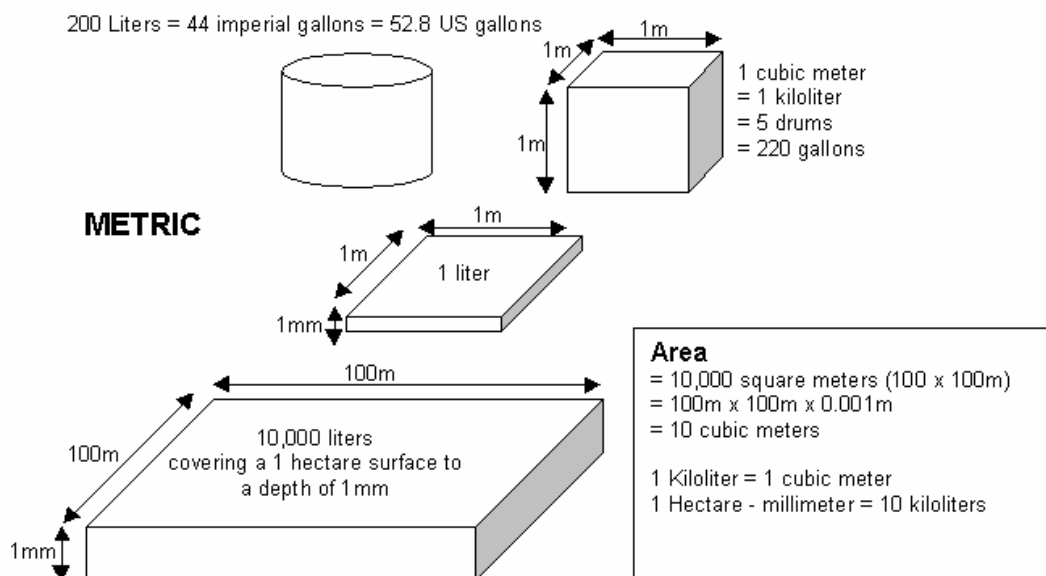

Imperial measurement units:

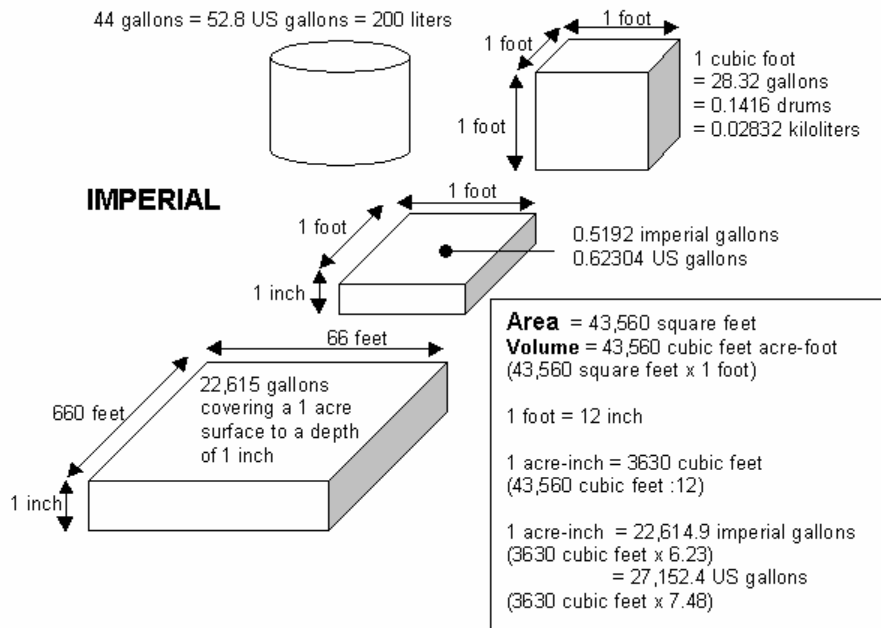

What part of the soil profile does the Diviner 2000 measure?

The first depth level is located at a soil depth of 10 cm (if the datum plate of the top cap sits on ground level) measuring effectively the soil profile slice of 5–15 cm depth. The next depth level is located at 20 cm measuring effectively 15–25cm soil depths. With further depth level at 10 cm intervals on the probe rod, the measurement depth is 25-35 cm, 35-45 cm, etc.

If you raise the datum plate of the top-cap five centimeters above the ground surface and place the center of the first measuring depth level effectively at five centimeters soil depth, the sphere of influence of the depth level measures a soil slice from 0–10 cm. For the other depth levels at 10 cm intervals on the probe rod, the measurement depth is 20–30 cm, 30-40 cm, etc.

What will be summed?

The moisture content on incremental 10 cm thick soil slices are summed in any given soil profile. For example, your probe measures at the following depth levels giving respective readings in mm:

Profile 1		Profile 2	
Depth	H₂O	Depth	H₂O
10cm	13mm	10cm	13mm

Appendix B—Soil Moisture Management

Profile 1		Profile 2	
Depth	H₂O	Depth	H₂O
20cm	22mm	20cm	22mm
30cm	25mm	Total	35mm
40cm	27mm		
50cm	28mm		
Total	115mm		

Where:

- The total soil moisture content from 10 to 50 cm is 115 mm (Profile 1).
- The total soil moisture content from 10 to 20 cm is 35 mm (Profile 2).

Appendix C—Creating a customized calibration equation

Ø To calibrate using the gravimetric/volumetric technique

1. Install six access tubes, two in wet soil, two in moist soil and two in dry soil, using the appropriate installation method.

Note: The wet site may need artificial ponding with water. The dry site may need the establishment of a fast growing deep-rooted crop to dry out the soil profile. The distinctions must be clear. Refer to installation diagram below.

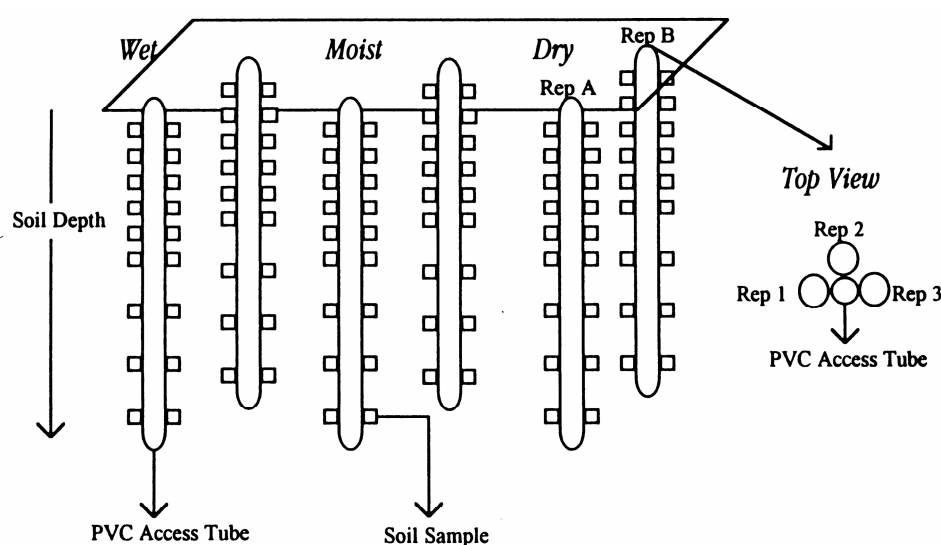

2. At each depth on the probe take three Diviner 2000 raw count readings e.g. 10cm, 20 cm, 30cm.
3. Calculate the scaled frequency for each sample.

$$SF = (F_A - F_S) (F_A - F_W)^{-1}$$

Where:

- F_A is the frequency reading in the access tube while suspended in air
- F_S is the reading frequency in the access tube in soil at a particular depth level
- F_W is the reading frequency in the access tube in the water bath.

4. Prepare a table to record the SF readings per depth plane. Do not average your readings. Record them separately.

Depth	SF Sample 1	SF Sample 2	SF Sample 3
10 cm			
20 cm			
30 cm			

5. Dig a trench beside the access tubes (approx. 30 cm).
6. Use three thin walled stainless steel rings to sample soil water and bulk density.

Notes:

- Make sure that the area ratio of the cylinder is less than 0.1, i.e. the area of the cross section of metal to that of soil.
 - For a 75 x 75 mm cylinder, 16 gauge tubing gives maximum wall thickness.
 - The area ratio for these samplers is 0.09.
7. Drive the rings in so that they just touch the access tube.
 8. Stop driving when the centre of the ring matches the centre of the sphere of influence of the sensor field.
 9. Use a series of platforms to sample at each depth.

Notes:

- Each sample point has sampling rings driven in by a sledge-hammer via a sampling ring tube extension.
 - Remove the soil above the sampling depth without compressing the layer to be volume sampled.
10. Remove soil samples with sufficient over burden (excess soil) and trim each core with care using a spatula
Note: Record any loss of soil from the sample ring.

11. Store samples in sealed plastic bags.

12. Conduct the gravimetric soil moisture content and bulk density determination using the standard technique as soon as possible.

Note: The bulk density is defined as the ratio of the mass of a given sample to its bulk volume. The mass is obtained by drying the sample at 105°C to constant weight, and the volume is the volume of the core sampler.

13. Calculate as follows:

If:

- M_w = wet mass of soil core (g)

- M_d = dry mass of soil core (g)
- V = bulk volume (cm³)
- Bulk density $\rho = M_d/V$ cm⁻³
- Gravimetric water content $W = (M_w - M_d)/M_d$ (g g⁻¹)
- Volumetric water content $\theta = W\rho^1$.

14. Prepare a table to record the determined values of volumetric soil moisture content readings per depth plane. Do not average. Keep the samples separate.

Depth	Vol% Sample 1	Vol% Sample 2	Vol% Sample 3
10 cm			
20 cm			
30 cm			

15. Plot SF on the Y-axis and Vol % on the X-axis in replicate pairs per depth level and fit appropriate calibration curve.

Note: Calibration equations may not fit all points adequately on a single calibration for that profile. This is particularly relevant for soil profiles with different textural layers. You may wish to generate separate calibration equations for individual soil layers at a particular depth level. The Diviner 2000 can process data using a different calibration equation for each 10 cm depth level increment.

16. Type new calibration equation(s) into the Diviner 2000 display unit using the procedure on page.

Errors to avoid

Calibration for absolute data may incorporate the following errors. They must be corrected.

1. In soil sampling:

- sampling wrong depth plane in relation to sensor reading
- sampling outside the sphere of influence of the sensor
- soil drying process, i.e. insufficient temperature, insufficient drying time.

2. In the timing:

- between sensor reading and soil sampling especially in coarse sand with a relatively high soil moisture content, where changes occur in seconds and in minutes.

3. In volumetric measurement:

¹ Source: Soil water assessment by the neutron method – E.L. Greacen, CSIRO Australia, 1981, CSIRO Division of Soils – Adelaide)

- sample weight, bulk density.

4. In site selection:

- insufficient spread of moisture content between wet, moist and dry sampling site to yield data for a suitable calibration curve
- access tube installation with air gaps and soil compactions.

4. In mathematical and statistical procedures:

- errors in calculations
- using unsuitable curves for the equation.

Appendix D—Software License Agreement

Software License Agreement

PLEASE CAREFULLY READ THE FOLLOWING TERMS AND CONDITIONS, SIGN THE REGISTRATION CARD WHERE INDICATED, AND RETURN TO SENTEK.

SOFTWARE LICENSE AGREEMENT (Single User)

I. LICENSE

- 1.1** Sentek Pty Ltd. ('Sentek') grants you, the Licensee, a limited non-exclusive license to use the software program Diviner 2000 Utilities ('Software') and accompanying user manual under the terms and conditions of this License. Licensee shall not use, copy, modify, sublicense, sell or transfer the Software or user manual or any portion thereof except as provided in this License.
- 1.2** Licensee may: **i)** install and use the Software in machine-readable, compiled Object Code form on a single computer terminal; and **ii)** copy the Software only for the purposes of installing and using the Software on a single computer as described above. Licensee may make only one copy of the Software and user manual for backup or archival purposes.
- 1.3** Licensee shall not: **i)** sublicense the Software; **ii)** reverse engineer, decompile or disassemble the Software; **iii)** make derivatives, modifications, or translations of the Software or user manual; or **iv)** copy the Software or user manual, in whole or in part, except as provided in this License.

II. OWNERSHIP AND COPYRIGHT OF SOFTWARE

- 2.1** Licensee acknowledges that all rights, title and interest to the Software and user manual remain with Sentek. The Software and user manual are copyrighted and protected by the laws of Australia and other countries, and international treaty provisions. Copyrighted material includes all forms and matters of copyrightable material and information now allowed by statutory or common law or hereinafter granted, including without limitation, material generated from the Software that is displayed on the screen such as icons and screen displays. Any backup and archival copies made by Licensee shall be the sole and exclusive property of Sentek. Licensee shall not remove any proprietary or copyright notice from the Software or user manual. With respect to installation and backup copies, Licensee will reproduce and include all

Sentek proprietary and copyright notices and other legends in the same manner that Sentek provides such notices and legends, both in and on every copy of the Software and user manual in any form. Except as otherwise provided, Sentek grants no express or implied right under Sentek patents, copyrights, trademarks, or other intellectual property rights.

- 2.2 Licensee agrees to prevent any unauthorized copying or use of the Software and user manual. Licensee will notify Sentek of any instances where it knows or has reason to believe that any person or entity intends to copy or use the Software and user manual in an unauthorized manner.
- 2.3 Licensee shall not use the Software and user manual in the performance of a contract or subcontract with any Government in a manner so as to affect Sentek's rights to the Software and user manual. If Licensee desires to use the Software or user manual in the performance of a contract or subcontract with a Government, prior to such use, Licensee shall consult with Sentek as to the procedures and use of restrictive markings required to protect the ownership interest of Sentek.

III. LIMITED WARRANTY

- 3.1 Sentek warrants that the media on which the Software is furnished will be free from defects in materials and workmanship under normal use for a period of thirty (30) days from the date of purchase ('Warranty Period'). Licensee must notify Sentek in writing of the nonconformance of the Software within the warranty period and return the Software to Sentek within thirty (30) days after such discovery. Upon Licensee's return of any media that proves to be defective in materials or workmanship, shipping prepaid, Sentek will replace the Software without charge. Such replacement shall be Licensee's sole and exclusive remedy.
- 3.2 Sentek does not warrant that the Software will meet Licensee's requirements or that operation of the Software will be uninterrupted or error-free. Sentek does not warrant or assume responsibility for the accuracy or completeness of any information, text, graphics, links or other items contained within the Software.
- 3.3 THE SOFTWARE AND USER MANUAL ARE PROVIDED 'AS IS' WITHOUT WARRANTY OF ANY KIND, EXPRESS OR IMPLIED, CONCERNING THE SOFTWARE OR USER MANUAL, OR THE USE OR OPERATION THEREOF, OR THE DATA GENERATED BY THE OPERATION OR USE THEREOF. SENTEK HEREBY EXCLUDES AND DISCLAIMS ALL IMPLIED WARRANTIES, INCLUDING, BUT NOT LIMITED TO, ANY IMPLIED WARRANTY OF MERCHANTABILITY OR FITNESS FOR A

PARTICULAR PURPOSE, ANY WARRANTY OF NON-INFRINGEMENT OF INTELLECTUAL PROPERTY, OR ANY IMPLIED WARRANTY FROM A COURSE OF DEALING OR USAGE OF TRADE.

IV. LIMITATION OF LIABILITY

IN NO EVENT SHALL SENTEK HAVE ANY LIABILITY FOR ANY INDIRECT, INCIDENTAL, CONSEQUENTIAL AND SPECIAL DAMAGES, INCLUDING BUT NOT LIMITED TO, LOSS OF USE, BUSINESS INTERRUPTIONS, LOSS OF PROFITS, INFRINGEMENT OF INTELLECTUAL PROPERTY OR REPROCUREMENT COSTS, REGARDLESS OF WHETHER SENTEK HAS BEEN ADVISED OF THE POSSIBILITY OF ANY SUCH DAMAGE OR LOSS. IN NO EVENT SHALL SENTEK'S LIABILITY FOR DAMAGES EXCEED THE LICENSE FEE PAID TO SENTEK FOR THE RIGHT TO USE THE SOFTWARE UNDER THIS LICENSE.

V. NO OTHER AGREEMENTS

The distributors and dealers of Sentek, including their agents and employees, are not authorized to modify this License nor to make statements, representations or terms binding on Sentek. Any statements, representations or terms not made or given directly and expressly by Sentek, whether written or oral, are not binding on Sentek.

VI. AUDIT

Sentek reserves the right to conduct audits to verify Licensee's compliance with this License.

VII. TERM AND TERMINATION

Sentek may terminate this License at any time if Licensee is in breach of any of its terms and conditions. Upon termination, Licensee will immediately destroy the Software and user manual or return all copies of the Software and user manual to Sentek.

VIII. COMPLIANCE WITH LAWS

Licensee will at all times comply with all applicable laws, rules and regulations of Australia and of any other jurisdiction in which Licensee uses the Software and user manual.

IX. EXPORT

Licensee agrees that the distribution and export/re-export of the Software and user manual is in compliance with the laws, regulations, orders or other restrictions of the Australian Government. Additionally, imports and

exports may be regulated by government agencies in other countries. Intra-country restrictions may be applicable regarding use of the Software and user manual. Licensee agrees that the distribution and import, export and re-export of the Software is in compliance with all applicable laws, regulations, orders or other restrictions.

X. APPLICABLE LAW

The validity, interpretation and performance of this License shall be controlled by and construed under the laws of the Australia and South Australia, except for the UN convention on Contracts for the International Sale of Goods, which is expressly rejected. Any claim arising out of this License shall be brought in the state or federal courts in the State of South Australia, Australia and each party consents to the jurisdiction of such courts.

XI. SEVERABILITY

If any of the provisions or portions thereof of this License are determined to be illegal, invalid or unenforceable, for any reason, then such provision shall be deemed to be stricken for the purpose of the dispute in question, and all other provisions shall remain in full force and effect.

XII. NOTICES

Notices required or permitted by this License must be sent to the address set forth in the signature block below, or to such other address as the parties may from time to time by written notice provide. Notice is effective when actually received if sent by any means that leaves a hard copy record in the hands of the recipient. If sent by registered or certified mail, postage prepaid, return-receipt requested, notice shall be deemed effective on the date the return receipt shows the notice was accepted, refused or returned undeliverable.

Software License Agreement (US and other countries)

PLEASE CAREFULLY READ THE FOLLOWING TERMS AND CONDITIONS, SIGN THE REGISTRATION CARD WHERE INDICATED, AND RETURN TO SENTEK.

SOFTWARE LICENSE AGREEMENT (Single User)

I. LICENSE

- 1.1 Sentek Pty Ltd. ('Sentek') grants you, the Licensee, a limited non-exclusive license to use the software program Diviner 2000 Utilities ('Software') and accompanying user manual under the terms and conditions of this License. Licensee shall not use, copy, modify, sublicense, sell or transfer the Software or user manual or any portion thereof except as provided in this License.
- 1.2 Licensee may: **i)** install and use the Software in machine-readable, compiled Object Code form on a single computer terminal; and **ii)** copy the Software only for the purposes of installing and using the Software on a single computer as described above. Licensee may make only one copy of the Software and user manual for backup or archival purposes.
- 1.3 Licensee shall not: **i)** sublicense the Software; **ii)** reverse engineer, decompile or disassemble the Software; **iii)** make derivatives, modifications, or translations of the Software or user manual; or **iv)** copy the Software or user manual, in whole or in part, except as provided in this License.

II. OWNERSHIP AND COPYRIGHT OF SOFTWARE

- 2.1 Licensee acknowledges that all rights, title and interest to the Software and user manual remain with Sentek. The Software and user manual are copyrighted and protected by laws of the United States and other countries, and international treaty provisions. Copyrighted material includes all forms and matters of copyrightable material and information now allowed by statutory or common law or hereinafter granted, including without limitation, material generated from the Software that is displayed on the screen such as icons and screen displays. Any backup and archival copies made by Licensee shall be the sole and exclusive property of Sentek. Licensee shall not remove any proprietary or copyright notice from the Software or user manual. With respect to installation and backup copies, Licensee will reproduce and include all Sentek proprietary and copyright notices and other legends in the same manner that Sentek provides such notices and legends, both in and on every copy of the Software and user manual in any form. Except as

otherwise provided, Sentek grants no express or implied right under Sentek patents, copyrights, trademarks, or other intellectual property rights.

- 2.2 Licensee agrees to prevent any unauthorized copying or use of the Software and user manual. Licensee will notify Sentek of any instances where it knows or has reason to believe that any person or entity intends to copy or use the Software and user manual in an unauthorized manner.
- 2.3 Licensee shall not use the Software and user manual in the performance of a contract or subcontract with any Government in a manner so as to affect Sentek's rights to the Software and user manual. If Licensee desires to use the Software or user manual in the performance of a contract or subcontract with a Government, prior to such use, Licensee shall consult with Sentek as to the procedures and use of restrictive markings required to protect the ownership interest of Sentek.

III. LIMITED WARRANTY

- 3.1 Sentek warrants that the media on which the Software is furnished will be free from defects in materials and workmanship under normal use for a period of thirty (30) days from the date of purchase ('Warranty Period'). Licensee must notify Sentek in writing of the nonconformance of the Software within the warranty period and return the Software to Sentek within thirty (30) days after such discovery. Upon Licensee's return of any media that proves to be defective in materials or workmanship, shipping prepaid, Sentek will replace the Software without charge. Such replacement shall be Licensee's sole and exclusive remedy.
- 3.2 Sentek does not warrant that the Software will meet Licensee's requirements or that operation of the Software will be uninterrupted or error-free. Sentek does not warrant or assume responsibility for the accuracy or completeness of any information, text, graphics, links or other items contained within the Software.
- 3.3 THE SOFTWARE AND USER MANUAL ARE PROVIDED 'AS IS' WITHOUT WARRANTY OF ANY KIND, EXPRESS OR IMPLIED, CONCERNING THE SOFTWARE OR USER MANUAL, OR THE USE OR OPERATION THEREOF, OR THE DATA GENERATED BY THE OPERATION OR USE THEREOF. SENTEK HEREBY EXCLUDES AND DISCLAIMS ALL IMPLIED WARRANTIES, INCLUDING, BUT NOT LIMITED TO, ANY IMPLIED WARRANTY OF MERCHANTABILITY OR FITNESS FOR A PARTICULAR PURPOSE, ANY WARRANTY OF NON-INFRINGEMENT OF INTELLECTUAL PROPERTY, OR ANY

IMPLIED WARRANTY FROM A COURSE OF DEALING OR USAGE OF TRADE.

IV. LIMITATION OF LIABILITY

IN NO EVENT SHALL SENTEK HAVE ANY LIABILITY FOR ANY INDIRECT, INCIDENTAL, CONSEQUENTIAL AND SPECIAL DAMAGES, INCLUDING BUT NOT LIMITED TO, LOSS OF USE, BUSINESS INTERRUPTIONS, LOSS OF PROFITS, INFRINGEMENT OF INTELLECTUAL PROPERTY OR REPROCUREMENT COSTS, REGARDLESS OF WHETHER SENTEK HAS BEEN ADVISED OF THE POSSIBILITY OF ANY SUCH DAMAGE OR LOSS. IN NO EVENT SHALL SENTEK'S LIABILITY FOR DAMAGES EXCEED THE LICENSE FEE PAID TO SENTEK FOR THE RIGHT TO USE THE SOFTWARE UNDER THIS LICENSE.

V. NO OTHER AGREEMENTS

The distributors and dealers of Sentek, including their agents and employees, are not authorized to modify this License nor to make statements, representations or terms binding on Sentek. Any statements, representations or terms not made or given directly and expressly by Sentek, whether written or oral, are not binding on Sentek.

VI. AUDIT

Sentek reserves the right to conduct audits to verify Licensee's compliance with this License.

VII. TERM AND TERMINATION

Sentek may terminate this License at any time if Licensee is in breach of any of its terms and conditions. Upon termination, Licensee will immediately destroy the Software and user manual or return all copies of the Software and user manual to Sentek.

VIII. COMPLIANCE WITH LAWS

Licensee will at all times comply with all applicable laws, rules and regulations of the United States and of any other jurisdiction in which Licensee uses the Software and user manual.

IX. EXPORT

Licensee agrees that the distribution and export/re-export of the Software and user manual is in compliance with the laws, regulations, orders or other restrictions of the U.S. Government. Additionally, imports and exports may be regulated by government agencies in other countries. Intra-country restrictions may be applicable regarding use of the Software and user

manual. Licensee agrees that the distribution and import, export and re-export of the Software is in compliance with all applicable laws, regulations, orders or other restrictions.

X. APPLICABLE LAW

The validity, interpretation and performance of this License shall be controlled by and construed under the laws of the United States of America and the state of Oregon, U.S.A., except for the UN convention on Contracts for the International Sale of Goods, which is expressly rejected. Any claim arising out of this License shall be brought in the state or federal courts in the state of Oregon, U.S.A., and each party consents to the jurisdiction of such courts.

XI. SEVERABILITY

If any of the provisions or portions thereof of this License are determined to be illegal, invalid or unenforceable, for any reason, then such provision shall be deemed to be stricken for the purpose of the dispute in question, and all other provisions shall remain in full force and effect.

XII. NOTICES

Notices required or permitted by this License must be sent to the address set forth in the signature block below, or to such other address as the parties may from time to time by written notice provide. Notice is effective when actually received if sent by any means that leaves a hard copy record in the hands of the recipient. If sent by registered or certified mail, postage prepaid, return-receipt requested, notice shall be deemed effective on the date the return receipt shows the notice was accepted, refused or returned undeliverable.

Index

- A**
- Absolute data 14, 18
 - AC adaptor *See* battery
 - access tube 16, 19, 64
 - Adjust *See* Setting
 - agronomists 3
- B**
- Backing up 52
 - Backlight 13
 - Battery
 - charge level 9
 - charge time required 8
 - charging 9
 - power pack 8
 - storage life 5
- C**
- Calibration 14
 - calibration equation
 - customized 18
 - default 15
 - definition 14
 - Calibration mode 18
 - Care of equipment 4
 - Charging *See* Battery
 - Connecting
 - display unit to the probe 9
 - connector
 - external power 7
 - PC interface 7
 - Probe Input 7
 - crop
 - soil water extraction phases 33
- D**
- Datum
 - aligning 20
 - datum plate 17, 18
 - datum plate up 5cm 67
 - definition 16
 - Deleting
 - a data point 27
 - a profile 28
 - all data points 28
 - Diviner 2000
 - Backlight 13
 - battery 9
 - calibration screen 16
 - charging 8
 - connection panel 7
 - datum value 16
 - display unit 2, 6
 - formatting 28
 - memory status 9
 - overview 2
 - probe 2, 7
 - scan screen 19
 - setup screen 11
 - starting 8
 - status screen 9
 - unit config screen 29
 - video 3
 - Diviner Utilities
 - configure 51
 - ESW ID Tags 57
 - exporting data 53
 - File formats 47
 - help 47
 - installing 48
 - main window 49
 - starting 49
 - version 47
 - Document conventions 1
 - dust cap 4, 7, 9
- E**
- EnviroSCAN 15
 - ESW ID Tags 57
 - evapo-transpiration 35
 - Exporting data 53
 - csv file 55
 - messages 56
- F**
- Field capacity 35, 43
 - Full point 24, 27, 39
 - definition 43
- G**
- Graphs 24
 - single mode 24
 - summed mode 26
 - gravimetric sampling 14, 18
- I**
- imperial units (inches) 13
 - Irrigation chart
 - plotting 30
 - Irrigation management
 - charts 30
 - scheduling 29
 - soil moisture 29
 - Irrigation Management Chart 2, 30
- K**
- Key
 - Function 6
 - Mode 7
 - Navigation 6
 - Numeric 7
- L**
- LCD contrast 14

Index

M		Scan	
Measurement		continuous.....	21
Raw counts.....	64	mode.....	13, 19
Scaled frequency.....	64	Swipe and go.....	20
water units.....	66	sensor head.....	5, 13, 20
metric units (cm).....	13	serial baud rate.....	14
Mode		Setting	
calibration.....	16	air count.....	12
configuration.....	29	date.....	11
continuous.....	21	default screen.....	13
scan.....	19	LCD contrast.....	14
setup.....	10, 11, 51	serial baud rate.....	14
table.....	22	time.....	11
N		Units.....	13
Neutron probe.....	18	water count.....	12
normalization tube.....	12	Setup.....	10
Normalizing.....	12	Single mode.....	24
O		Soil water budgets.....	45
Online help.....	47	Special codes	
onset of stress.....	35, 39	#2020.....	28
over-irrigation.....	35, 41	#9990.....	61
P		sphere of influence.....	66, 67, 70, 71
PAW Plant Available Water.....	35	Status screen.....	9
Permanent Wilting Point.....	35	Summed mode.....	26
power pack.....	8, 61, <i>See</i> Battery	Swipe and go.....	2, 20
probe		T	
connecting.....	9	Table	
continuous mode.....	21	modes.....	22
length.....	2, 7	set full, refill, mark.....	24
normalizing.....	12	single mode.....	23
overview.....	2	summed mode.....	23
swipe-and-go mode.....	20	Table mode.....	24
R		Trend interpretation.....	33
RACW Readily Available Water Capacity.....	35	Troubleshooting	
Readings		battery charging.....	61
first scan.....	20	communication settings.....	60
frequency.....	2, 30	fatal errors.....	61
recommended frequency.....	33	formatting Diviner 2000.....	60
Recording		scan failures.....	61
continuous mode.....	19	unlocking the display unit.....	60
EnviroSCAN continuous.....	15	V	
scan mode.....	6, 10, 19, 20	video	
soil moisture.....	19	swipe and go.....	3
Relative data.....	14, 15	volumetric sampling.....	14
Restoring data.....	55	W	
root zone.....	3, 30, 35, 36, 38, 39, 40, 41	water in tube.....	5, 20
S		water table.....	3, 30, 36, 45
scaled frequency.....	14	water units	
scan		definition.....	66
failed.....	20	imperial.....	67
		metric.....	66
		water-logging.....	44
		wetting front.....	3